



SureFeed®

Microchip Pet Feeder Connect

User Manual

EN:	User Manual	1-28
DE:	Bedienungsanleitung	29-56
FR:	Guide d'utilisation	57-84
NL:	Handleiding	85-112
ES:	Manual del usuario	113-140
IT:	Manuale utente	141-168
PT:	Manual do utilizador	169-196
FI:	Käyttöopas	197-224
SV:	Bruksanvisning	225-252
BR:	Manual do usuário	253-280
CN:	用户手册	281-308

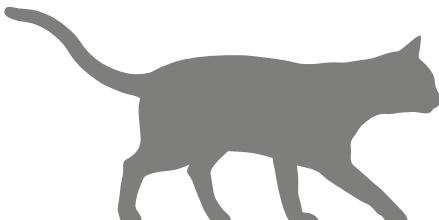



Welcome to your new Microchip Pet Feeder Connect

Thank you for choosing the Microchip Pet Feeder Connect!

The Microchip Pet Feeder Connect system is made up of three elements all working together to keep you connected to your pet and provide more insight into their eating habits.

The **Microchip Pet Feeder Connect** is the main component of the system. It recognises the microchip ID already implanted in your pet or the Sure Petcare RFID Collar Tag (one included), allowing your pet to access their food whilst keeping out other animals.

The **Hub** (sold separately) is the connected element of the system. It connects to your home internet and can talk to both the Feeder and your Sure Petcare app.

By using the **Sure Petcare app**, you'll be able to monitor the amount of food that your pet has eaten and how frequently they visit the Feeder. The app also allows you to send a portion weight to the Feeder so you can control the amount of food per serving.

What's in the box

Please make sure you have all these parts*

- 1 x Microchip Pet Feeder Connect
- 1 x Single bowl
- 2 x Half bowls
- 1 x Mat
- 1 x Single bowl support
- 2 x Half bowl supports
- 1 x Sure Petcare RFID Collar Tag

*Batteries and Hub are not included

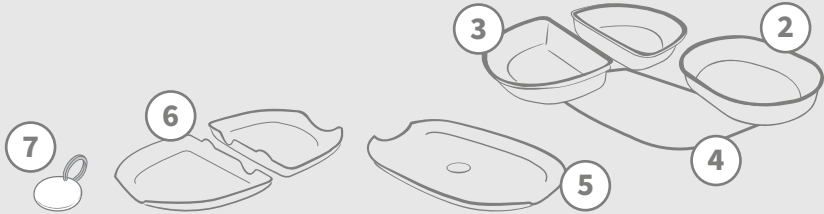
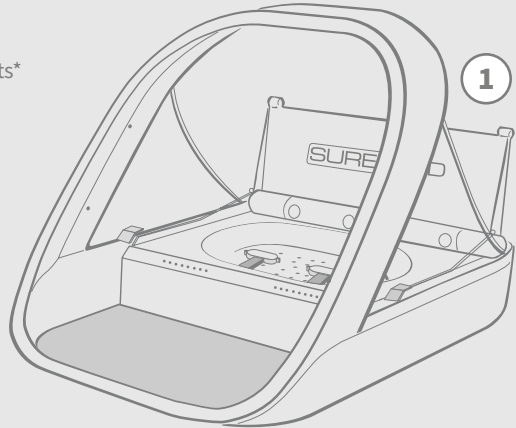

In order for your Microchip Pet Feeder Connect to work as a connected system you will need to purchase an accompanying Hub. For more information on how to purchase a Hub please visit surepetcare.com/hub.

Contents

Important information	3
Product overview	5
Microchip Pet Feeder Connect system	7
Hub	
Set up your Hub	8
Where to put your Hub.....	9
Hub lights	10
Feeder	
Batteries	11
Connect your Feeder.....	12
Buttons & lights	13
Adding your pet to the Feeder	15
Setting Portions	16
Adding & replacing the food	17
Training mode	19
Cleaning & maintenance.....	21
Help & support	23
Warranty & disclaimer.....	27

i

Important information



PLEASE READ THE FOLLOWING INFORMATION CAREFULLY AND RETAIN THIS MANUAL FOR FUTURE REFERENCE.



This product is intended for **domestic pets only**.



Use only SureFeed accessories to ensure compatibility: surepetcare.com/accessories



Make sure you have all of the parts listed on **page 1**.



Don't place the Feeder in areas where people are walking past frequently.



The Feeder is designed for **indoor use only**.



Do not submerge the Feeder into water or place it under a running tap.



Do not place the Feeder in the fridge or put ice packs underneath or inside it.



Do not place the Feeder anywhere it may be exposed to excessive heat.



This product requires **4 x C cell batteries** which should be inserted and replaced with caution. Do not mix different types of batteries or use a combination of new and used batteries. If the Feeder is going to be stored unused for a long period, please remove the batteries.

You will find the **product code** and **serial number** for the Microchip Pet Feeder Connect on the underside of the product.

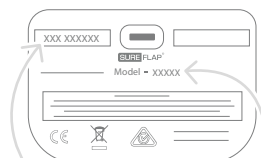

Serial number

Product code

Safety warnings

- **Do not** use this product if parts are missing, damaged or worn.
- **There are small components used in the construction of this item.** Any loose parts should be kept away from young children and pets to **avoid choking hazards**.

Other important things to consider



PETS: Sure Petcare recommends that the SureFeed Microchip Pet Feeder Connect is used with your pet's implanted microchip, however it may also be operated using the Sure Petcare RFID Collar Tag. If using the collar tag, it should be used with a safety collar which **incorporates a breakaway buckle** (cats only). Sure Petcare cannot accept liability for any injury or death caused by a pet's collar.



FOOD ACCESS: Sure Petcare cannot accept liability for any access obtained by an unauthorised pet due to unintended use. As the owner of this product, **you accept full responsibility for supervising the administration of any food** that could cause harm to other pets if consumed unintentionally.



NO TIMER FUNCTION: This product does not contain a timer and **does not have any time related functionality**. Therefore, do not leave your pet unattended, or rely on this product to sustain them for any prolonged periods of time - no longer than 24 hours for a cat, or the average amount of time between meals for a small dog. **This product is not a substitute for responsible pet ownership.**



CHILDREN: Children should **not be permitted to play with the SureFeed Microchip Pet Feeder Connect**. It is not a toy and should not be treated as such. However, this product can be used by children aged 8 years and above and also by persons with reduced physical, sensory or mental capabilities as long as they are supervised or have been given instructions on how to use the product in a safe way. They should always be made aware of any potential hazards involved. Do not allow children of any age to clean the product without supervision.



CHILD PROOFING: In households with children, it is essential to **include the SureFeed Microchip Pet Feeder Connect in any childproofing considerations**. Misuse of this product by a child may result in the child coming into contact with potential dangers. For this reason, young children should be monitored at all times when in the immediate vicinity of the Feeder. Please also be aware that when the Feeder is in **training mode** (see page 19-20) **a child will still be able to access the pet's food.**



Product overview

The Microchip Pet Feeder Connect system consists of three main components:

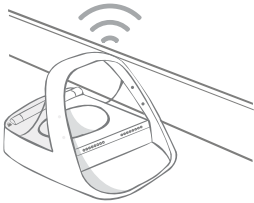

Microchip Pet Feeder Connect

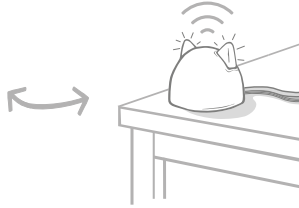

Hub

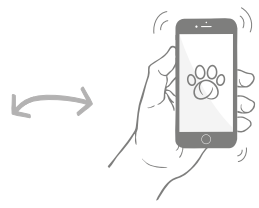

Sure Petcare app

The Hub is connected to the internet via an Ethernet cable and monitors the activity of your Microchip Pet Feeder Connect. It communicates with both the Feeder and the Sure Petcare app allowing you to see updates on the Sure Petcare app even when you're away from home!

You are also able to set a portion weight in the app. Once set, the Feeder will guide you as food is added to ensure your pet is getting the correct portion. For more information, **see page 14.**

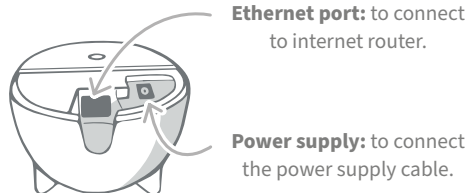
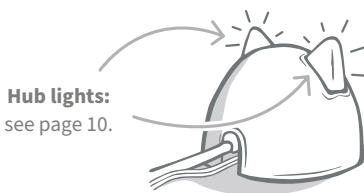
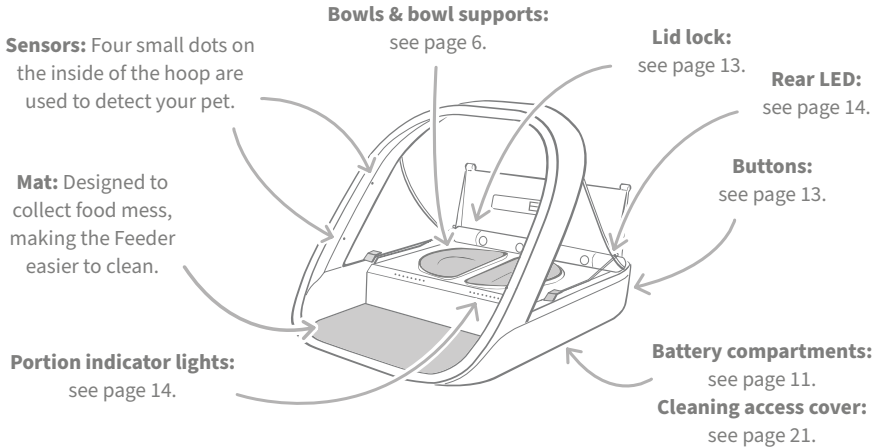

The SureFeed bowls have an integrated seal on their top edge helping to keep your pet's food fresher for longer. If you feed your pet only one type of food you can use the single bowl, but if you give them both wet and dry food, then the half bowls are perfect!



Single bowl - can hold 250g, which is enough for at least 2 wet food pouches.



Half bowls - each bowl can hold up to 100g, or 200g across both bowls.

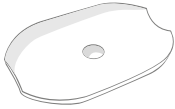

Single bowl support - is designed to hold the single bowl, (not the half bowls).



Half bowl supports - each one is designed to hold a half bowl, (not the single bowl).

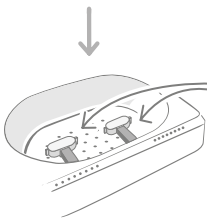

Weighing arms - designed to hold the bowl support.

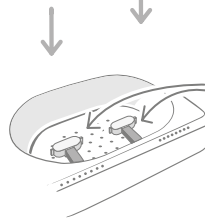

Weighing arms - designed to hold the bowl supports.



Do not put your pet's food directly on top of the bowl supports. Always use the bowls to ensure the correct functioning of the Feeder.

The SureFeed split bowl is not intended for use with the Microchip Pet Feeder Connect.

To purchase additional bowls or mats ask a Sure Petcare stockist or visit surepetcare.com.

Add some colour

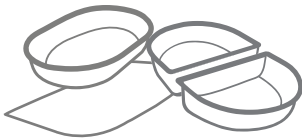

SureFeed plastic bowls and mats come in four different colours: blue, green, pink and grey.

Or add some shine

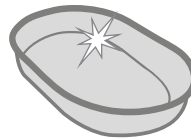

The SureFeed single bowl can also be purchased in stainless steel.



Do not put bowls in the dishwasher or microwave.



Hand-wash bowls before first use.



Microchip Pet Feeder Connect system

Download the free Sure Petcare app now

DOWNLOAD ON THE
APP STORE

GET IT ON
GOOGLE PLAY



surepetcare.io



Receive notifications when your pet eats from the Feeder.



Monitor your pet's food intake and notice changes in behaviour.



Accurately portion food to control the amount eaten per serving.



Share access to your household with family and friends.



Download the **Sure Petcare app** and create an account. You'll be asked to make a 'household' (a connected network containing all of your Sure Petcare connected products and pets). You can invite other members of your family to join your household.

To download the app, your phone or tablet must be running at least **iOS 9** on **Apple**, or **4.4** on **Android**.



If you'd rather control your Sure Petcare connected products from your computer, you can use the Sure Petcare web app at **surepetcare.io**.

You will need the latest version of **Safari**, **Chrome**, **Firefox** or **Internet Explorer** running on either **Mac OS X v10.9** (or above) or **Windows 7** (or above).

Purchase a Sure Petcare Hub



In order for your Microchip Pet Feeder Connect to work with the Sure Petcare app you will need to purchase an accompanying Hub. For more information please visit **surepetcare.com/hub**.



Set up your Hub

Once you have successfully downloaded the Sure Petcare app, you will need to plug in your Hub and set it up. Once your Hub is set up you will be asked to connect it to both the Feeder and the app. Please follow the steps below:

1

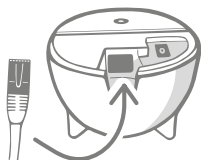

Plug one end of the Ethernet cable into the base of your Hub and the other end into a spare Ethernet port on your router.

2

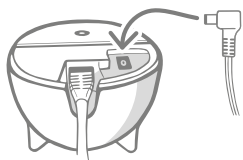

Assemble the power supply and plug it into your power outlet. Plug the other end of the cable into the base of your Hub.

3

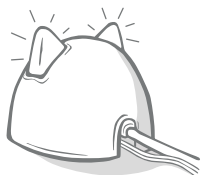

Your Hub's 'ears' will start **alternating red and then green**. When both ears remain solid green your Hub is ready. If the ears fail to do this sequence please **see page 10** for more information.

4



In order to complete the setup of your Microchip Pet Feeder Connect system you will need to **follow the remaining steps on the Sure Petcare app**.



Your Hub may receive a software update. If you see **solid red lights** during setup, don't panic, your Hub is updating its software. Once complete the Hub will reboot and you'll see the light sequence detailed in step 3.



Where to put your Hub

Because your Microchip Pet Feeder Connect system communicates wirelessly, the location of your Hub can affect its performance.



Place the Hub at least 1 metre off the ground (i.e. on a table that is as clear of obstructions as possible).

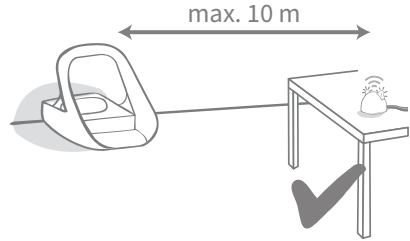

Try to position your Hub so that it is in line-of-sight of your Feeder and within a 10 metre radius.

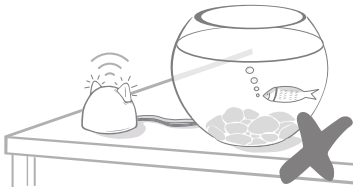

Avoid positioning your Hub near or in line of sight of any large amounts of water (i.e. fish tanks).

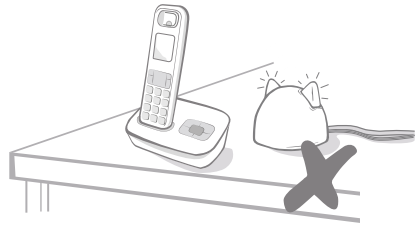

Keep your Hub as far away as possible from any potential sources of interference (i.e. digital cordless phones, baby monitors, etc).

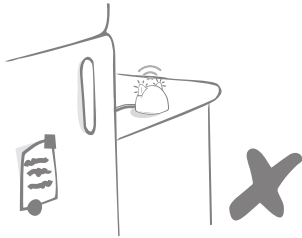

Make sure the Hub isn't positioned next to any large metal objects (i.e. fridges).

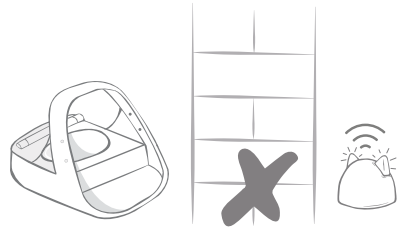

Avoid thick walls between the Hub and the Feeder.



Occasionally your Hub may experience connection issues despite following these tips. For further advice on how to move your Hub closer to your Microchip Pet Feeder Connect, go to surepetcare.com/hub-connectivity.



If your Hub loses internet connection for any reason, your Microchip Pet Feeder Connect will still function as normal and retain its settings.



Hub lights

Your Hub indicates its current state using the lights in its ears. Different coloured light sequences mean different things.

Setup lights

Every time the Hub powers up or is trying to connect to other elements of the system, you'll see the setup lights:

- 1** the ears will **alternate red** for a while,

- 2** then they will **alternate green**,

- 3** once you see a **flash of orange** and the ears go **solid green** the Hub is connected.



Green ears

Green ears mean the Hub is working correctly. See below for the details of what each light sequence means.

Both ears are solid green – Your Hub is turned on, connected and working correctly.

Alternating green ears – Your Hub is re-connecting to our servers.

Red ears

Both ears are solid red – Your Hub is doing a software update. Be patient, your Hub will reboot and continue as normal shortly.

Both ears flashing red – Your Hub has lost connection with your Feeder and is trying to reconnect.

Alternating red ears – Your Hub is having difficulty connecting to the internet and/or the servers.

- i** For more information on diagnosing these issues, **see page 24**.



Batteries

Always use **4 x good quality 1.5V alkaline C cell batteries**. This will ensure the best performance of your Microchip Pet Feeder Connect. **This product is NOT designed for use with rechargeable batteries.** To insert or change the batteries please follow the steps below:



There is a light near the rear of the Feeder. If the batteries are low, or if there's a problem with how they've been inserted, this light will flash red every 5 seconds.

1

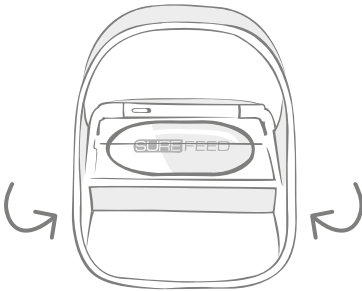

Turn the Feeder upside down to access the battery compartments.

2

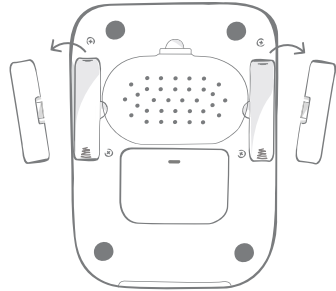

Remove the battery covers.

3

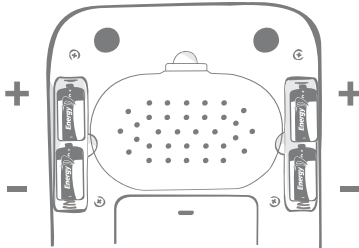

Insert the batteries. Ensure the +/- symbols on the batteries match the symbols on the Feeder itself.

4

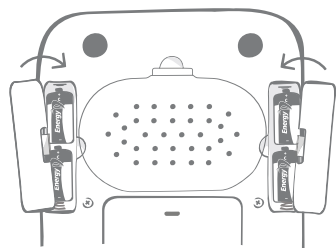

Replace the battery covers.



Once you program your pet's microchip ID into the Feeder it will be permanently stored in its memory. This means that even when you change the batteries, the Feeder will still recognise your authorised pet.



Connect your Feeder

In order to complete the setup of your connected system, you need to connect your Feeder to your Household.

1

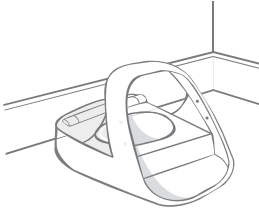

Place your Feeder in its intended location. This is to ensure it can communicate with the Hub.

2



On the Sure Petcare app, select '**Add product**'.

3



Your Hub will go into connecting mode and its ears will flash green.

4

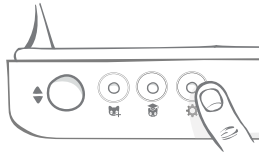

Press the settings button  on the Feeder once. The ear LED will illuminate green.

5

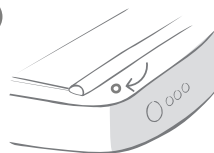

Once the Feeder is connected the LED will turn off and the Hub will stop flashing.

i

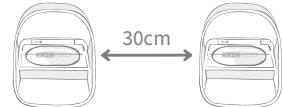

If you wish to connect more Feeders, you can do this easily from within the app.

Adding a Feeder to your current Household



You can add a Microchip Pet Feeder Connect to your existing Sure Petcare Household via the app. Go to the Household section and follow the instructions above.

You can also assign your pet's microchip ID remotely via the app. This means you won't have to add them manually. However, adding pets using treats can encourage them to use the new product. **See page 15** for more information on adding pets.



Buttons & lights

Buttons

There are 5 buttons on the Feeder. These can be found at the rear of the product:

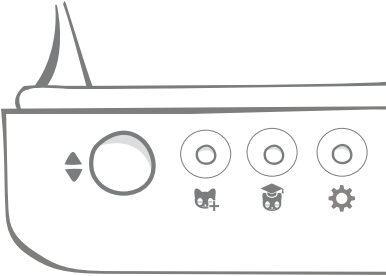

Open/close button - opens and closes the lid so you can access the bowl(s).



Add a pet button - used to add your pet's microchip ID into the Feeder - see page 15.



Training mode button - used to activate training mode which teaches your pet to use the Feeder - see page 19-20.



Settings button - used to connect the Feeder and the Hub - see page 12.



Zero button - used to calibrate the Feeder and ensure you are giving the correct amount of food - see page 17. This button will zero **both sides of the Feeder, whether you're using a single bowl or half bowls.**



When using **half bowls**, if you want to zero them independently you can do this using the **Sure Petcare app**.

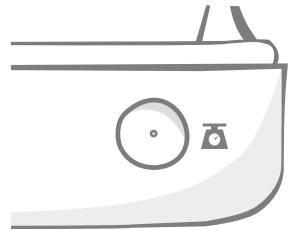

Lid lock



Locked - this means you cannot pull and remove the lid from the Feeder.



Unlocked - you are able to pull the lid when it's in the open position to remove it.

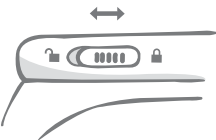
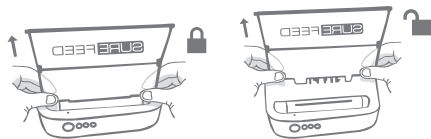

The lid lock should **remain locked** at all times and only be unlocked when you want to remove the lid for cleaning. This is so you can stop very clever unauthorised pets from trying to remove the lid to access the food. **Be aware that this doesn't prevent the lid from opening.**

Rear LED

Solid green light. The green light will come on every time an authorised pet eats from the Feeder.

Flashing green light. The Feeder is in 'Add a pet' mode - see page 15. The light will continue to flash until a microchip is added or until you exit the mode.

Flashing orange light. The Feeder is in training mode - see page 19-20. The number of flashes relates to the stage of training.

Flashing red light. The batteries are running low.

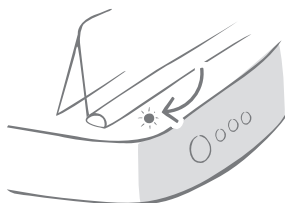

Portion indicator lights

If you've set a portion weight in the Sure Petcare app, the lights on the front of the Feeder will act as a guide when adding food.

The portion indicator lights will represent the amount of food you've added so you can ensure your pet is getting the correct portion.

For more information about the benefits of accurate portioning please see page 16.

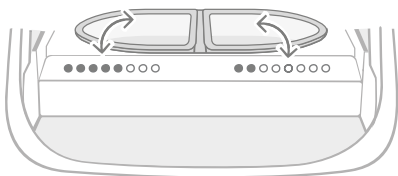
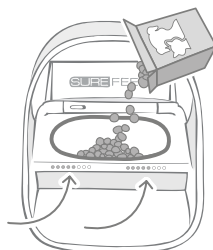

Using half bowls

The lights on the right-hand side of the Feeder correspond to the bowl on the right and it's the same for the left. The lights will illuminate when food is added to each side.

Using a single bowl

Both sets of lights will illuminate simultaneously when food is added to the single bowl.

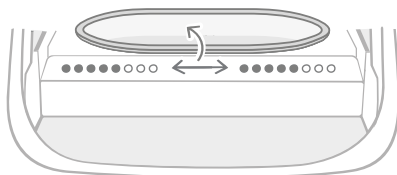

If you want to switch from half bowls to a single bowl and vice versa, you need to make the change via the Sure Petcare app.



If you haven't set a portion weight in the app, the lights will not illuminate when food is added to the Feeder.



Adding your pet to the Feeder

When adding your pet's microchip ID into the Microchip Pet Feeder Connect, make sure all other pets and any unrequired collar tags are kept out of the way.

1

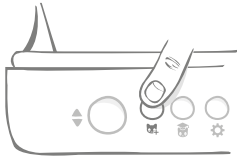

Press the 'Add a pet' (🐱) button found at the rear of the Feeder.

2

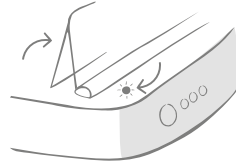

The lid will open and the rear LED will flash green once every second.

3

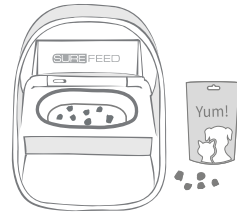

Put some food/treats into the bowl and place the Feeder where you would normally feed your pet.

4



Whilst your pet eats, the Feeder scans their microchip ID. Once the ID has been added, **the LED will stop flashing** (but remain on).

5

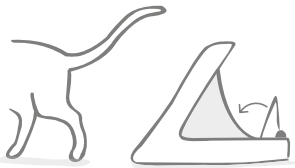

When your pet moves away, the lid will close and the green LED will turn off. Their microchip ID is now permanently stored.

i



If you need to, you can cancel the 'Add a pet' mode at any time with a second press of the 'Add a pet' (🐱) button.



To program a pet's microchip ID, sensors located in the hoop of the Feeder must detect the pet's presence. Therefore it's important to ensure your pet places their head through the hoop to eat.



To program a Sure Petcare RFID Collar Tag, simply follow the steps above but hold the collar tag inside the hoop. Make sure you are not wearing any metal jewellery when programming a collar tag.



If you already have a pet in your Sure Petcare household, it is possible to assign them to the Feeder. Go to the Household section of the app. If you add the wrong pet by mistake you can always correct it here.



Setting Portions

The Microchip Pet Feeder Connect not only monitors when and what your pet has been eating, it can also help you to provide accurate portions each time you feed your pet.

Why should you portion your pet's food?

Could your pet benefit from losing a few pounds?
By setting a portion weight you can ensure you're not accidentally giving them too much food every day. It all adds up!

The ability to weigh out portions of food directly into the Feeder makes it quicker, easier and more convenient to ensure your pet is eating the correct amount.

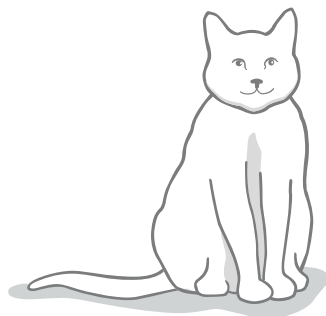

How much should you feed your pet?

It can be difficult to know how much is the right amount for your pet, especially when there is so much choice. We recommend consulting your vet or animal health advisor to see what they recommend.

Alternatively, stick to the guidelines provided on the packaging by the pet food manufacturer. This information is normally a good guide for average, healthy pets.

How to set the portion weight in the app

You can set the portion weight in the Sure Petcare app. Once set, this amount is sent to the Feeder so it knows how much food you want to give your pet per serving.

The portion indicator lights on the Feeder will then guide you as food is added, to ensure the correct portion is given. The lights represent the amount of food added, **see page 18** for more information.





Adding & replacing the food

It is important to change your pet's food on a daily basis, not only to ensure your pet stays happy and healthy, but also to keep the Feeder clean and in working order.

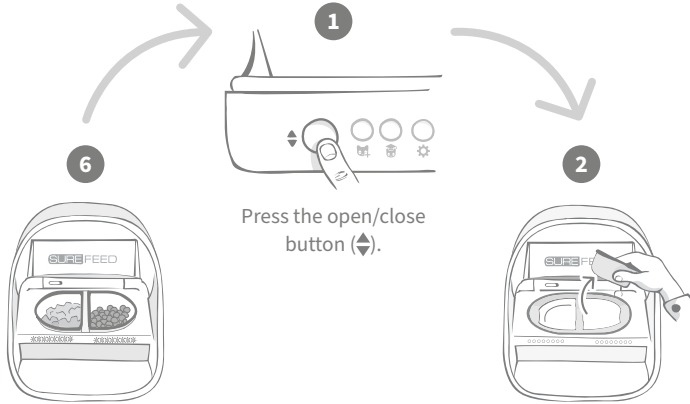

1
Press the open/close button (↕).

6
When all the lights are flashing green you have filled the bowls with the full portion.

2
Remove the dirty bowls and any debris. Clean them or replace with fresh ones.

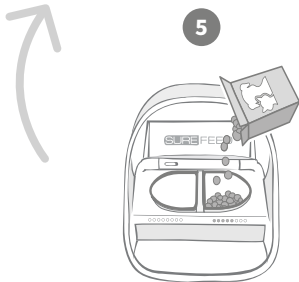

5
After the zeroing light sequence, start filling the bowls. The portion indicator lights will illuminate to show the amount of food in each bowl - see next page.

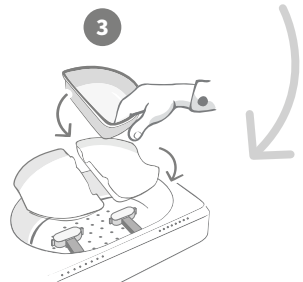

3
Make sure the appropriate single or half bowl supports are correctly sitting on the weighing arms and **place an empty bowl on top.**

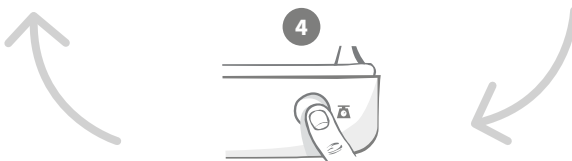

4
Press the zero button, before filling the bowls, to ensure you are giving a full portion to your pet. Remember that pressing this button will zero both sides of the Feeder - see page 13.

Portion indicator lights



Zeroing light sequence:

Descending green lights from right to left appear when you press the zero button.



Adding food:

As food is added, the portion indicator lights will light up green, increasing from left to right. The lights correspond to the amount of food in the bowl. You need to keep adding food until all the lights flash.



Reaching the portion weight:

When you are within +/- 1 g of the portion weight, the lights will **flash green**. If the lights aren't flashing, it is not quite a full portion.



Overfilling:

If you add more than the portion weight to the bowl, the **red lights** will warn you how much you've overfilled. Simply remove some of the food until you see the flashing green lights.



Please be aware if you haven't set a portion weight in the app, the portion indicator lights **will not illuminate** when food is added to the Feeder.

Food still left in the bowl?

If there is food still left in the bowl when it comes to dinner time, no need to press the zero button, simply add more food to the feeder and the feeder will let you add a new portion on top of existing food in the bowl. The portion indicator light will allow for a full portion amount to be added and indicate as such.

1

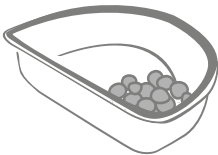

When you open the lid, some lights will momentarily flash on to indicate that the feeder knows there is some food left in the bowl. All lights will then disappear to allow you to add a new fresh portion on top of the remaining food.

2

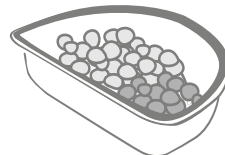

Fill the bowl until all the portion indicator lights are flashing green.



Training mode

(teaching your pet to use the Feeder)



When opened by the open/close button, the orange training light will flash red to help you identify that the open/ close button has been pressed and it is in open mode. The training light will return to orange when the open/close button is pressed once you have added the food portion. **If the Open/Close button isn't pressed the portion indicator lights will not activate and the system won't be able to identify you adding food.**

PART 1 - Introducing your pet to the Feeder

Some pets may need some time to get used to the Feeder. The training mode allows you to slowly introduce more and more movement to the lid meaning your pet can grow in confidence using their new bowl. This can take a little time but be patient, and do not move on to **PART 2** until your pet seems comfortable.

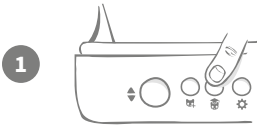

1

With the lid closed press the 'Training mode' button (⚙️) once on the rear of the Feeder. The lid will open and the rear LED will flash orange (once every few seconds).

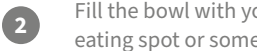

2

Fill the bowl with your pet's favourite food and place the unit in your pet's normal eating spot or somewhere they feel comfortable eating.



3

During this first stage of training your pet to use the Feeder, **the lid will not close** after they have finished eating.



Remember to take your time and let your pet get used to their new bowl. Once they are happy proceed to PART 2.

PART 2 - Increasing the lid movement

Slowly increasing the lid movement allows your pet to get used to it in three stages. Once again, for the best results and a happy pet, it is important to be patient and not rush this process. The amount of time required at each stage will vary for each pet (days/weeks) but we recommend taking a few days for each one.



4

Start to increase the motion of the lid by pressing the 'Training mode' button (⚙️) once again. The lid will close a small amount and the rear LED will flash orange twice.

5

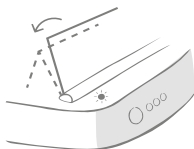

Now when your pet eats from the bowl there will be some movement as the lid opens fully. When they finish eating, it will close slightly.

6



Allow your pet time to get used to the new lid movement. When you need to replace their food do so as normal - **see page 17**. After replacing the food, ensure you press the open/close button (👉) to close the lid to its training position.



Remember to take your time. Do not proceed to the next stage until your pet is confident with this amount of lid movement.

7

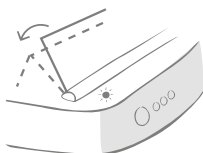

Once your pet is happy with the movement, press the 'Training mode' button (👑) again. The lid will close to the next position and the rear LED will now flash orange 3 times.



Again, continue to use the Feeder normally and do not proceed to the next stage until your pet is confident with this motion.

8

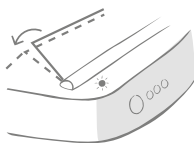

Your pet should be happy with the lid movement now so this final stage of training has the lid closed even further. As before, press the 'Training mode' button (👑) again. The lid will close to its final position and the rear LED will now flash orange 4 times.

9



Once your pet is happy with this final position, press (👑) again. The lid will close fully and the rear LED will no longer flash. The Feeder is now sealed and in daily use mode.



You can end the training mode at any time by pressing and holding the 'Training mode' button (👑) for **5 seconds**.



If you need to go back a step, follow the tip above. This takes the Feeder out of training mode and you can then start the process from the beginning.



If your pet appears nervous of the lid closing after they have backed away, on the Sure Petcare app you can adjust the length of time before the lid closes.



Cleaning & maintenance

It is important to keep your Microchip Pet Feeder Connect clean to ensure it functions reliably. **Do NOT submerge the whole unit into water or place it under a running tap! Water can cause damage to the Feeder and its electronics.**

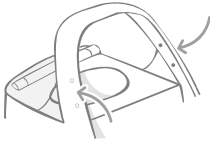
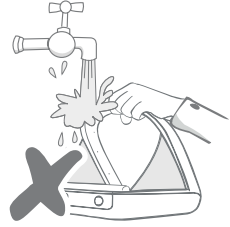

Ensure the four black dots on the hoop are kept clean at all times. The mat can be wiped clean using a damp cloth. **Do not put items in the dishwasher. Hand-wash only.**

The Microchip Pet Feeder Connect includes a **cleaning access cover** on its base to make it easier to remove crumbs or debris.

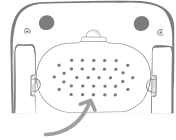

How to remove the lid for cleaning



Now flip the top half of the lid back over so it is resting on the lid guides.

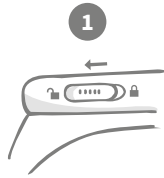

Move the lid lock slider to the unlocked position.



Press the (◀▶) button. Once the lid is open, pull it upwards.

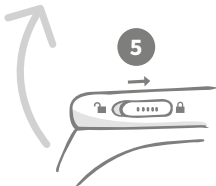

Move the lid lock slider back to the locked position.

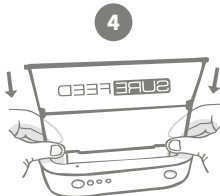

After cleaning, replace the lid keeping both halves vertical. Make sure it is securely fitted.

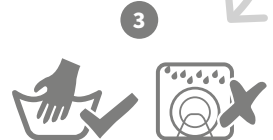

Hand-wash only. **Do not** put it in a dishwasher.

How to ensure your Feeder is kept clean

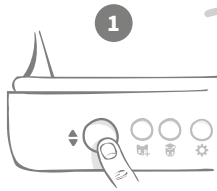

Press the open/close button (◊).

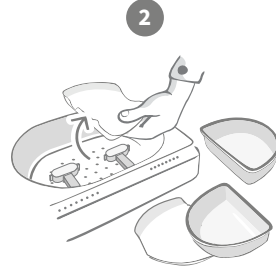

Remove the bowls, bowl supports and the lid - see previous page.



Reattach all of the parts, making sure to **attach the cleaning access cover first**.

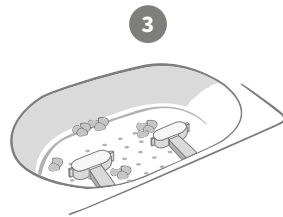

Debris stuck around the weighing arms can affect the performance of the Feeder, so it is very important to keep it clean.

Do not use any abrasive sponges as they can damage the Feeder and cause it not to work properly.

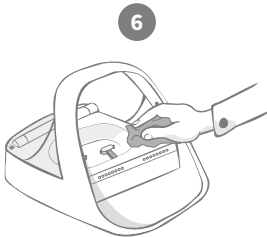

Use a damp cloth to ensure that all the surfaces of the Feeder are clean. **Do not use any abrasive cleaning products.**

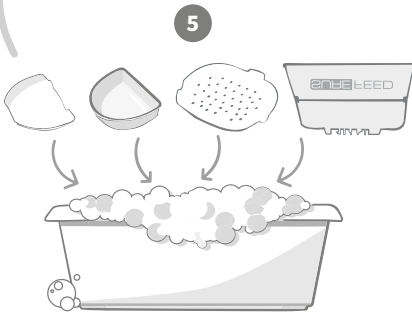

Hand-wash all the removable parts.
Do not put them in a dishwasher.

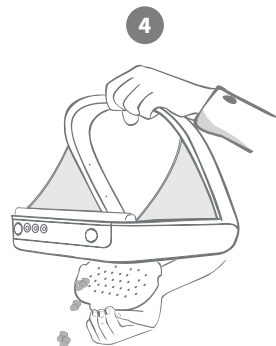

Hold the Feeder above the bin, remove the cleaning access cover and let the debris fall out.



Help & support

Custom settings

We understand that not all pets behave in the same way, so we've designed the Microchip Pet Feeder Connect to accommodate this. The Feeder contains a variety of custom settings designed to help if your pets use the Feeder in unexpected or unusual ways. Below are just a few examples of animal behaviour which the custom settings can overcome:

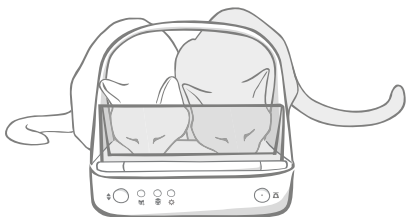

Does your unauthorised pet push their way in to eat at the same time as your authorised pet?

We have a custom setting for that!

Does your unauthorised pet like to steal food from another pet's Feeder whilst it's in training mode?

We have a custom setting for that!

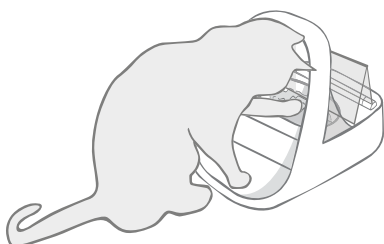

Has your clever unauthorised pet worked out how to stop the lid closing?

We have a custom setting for that!

Does your unauthorised pet try to steal food from the rear of the Feeder?

We have an accessory for that!

Go to [surepetcare.com/accessories](https://www.surepetcare.com/accessories) and look for the Rear Cover.

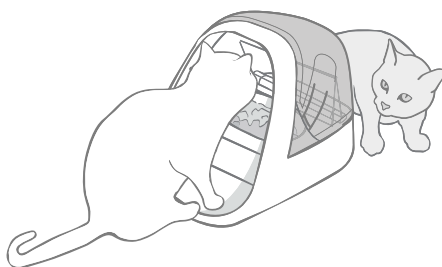

Please contact our customer care team to discuss custom settings - **see the back cover for details**. They'll be able to recommend the most appropriate custom setting for your situation and set it up for you remotely.

The Hub

Red flashing ears

Your Hub has lost connection with the Microchip Pet Feeder Connect.

- If you are seeing **both ears flashing red during setup**, please perform a factory reset by pressing the button on the base of your Hub for 10 seconds.
- If you are seeing **both ears flashing red for prolonged periods after setup**, try power cycling your Hub. Switch the power off at the socket, leave it for 30 seconds, and then turn it back on. If the ears remain solid green for a few minutes, the Hub has reconnected.
- You can also try **relocating your Hub** following the advice given on **page 9**. If that doesn't work, you will need to move your Hub closer to the Feeder - read below.
- In order to move your Hub closer try connecting it to your router using a longer Ethernet cable.
- If the above doesn't work, we recommend purchasing an '**Ethernet over power adapter**'. This will plug into a normal power socket and allow you to connect your Hub to the internet closer to your feeder.

Alternating flashing ears (red or green)

Your Hub is having problems connecting to the Sure Petcare servers. This could be because of an unreliable internet connection.

- Try power cycling your Hub by switching the power off at the socket, leaving it for 30 seconds, and then turning it back on. If the ears remain solid green for a few minutes, the Hub has reconnected.
- If the above doesn't work, make sure your internet router is turned on and that your internet connection is working correctly with other devices.
- If it isn't working with other devices, try switching your router off, leaving it for 30 seconds, and then turning it back on.
- If your router is working with other devices, try re-connecting the Ethernet cable into the router and the Hub. Make sure it is pushed in all the way, as it can appear connected when it isn't.

If you keep having connectivity issues please visit: surepetcare.com/hub-connectivity.

Solid red ears

Your Hub is undergoing a firmware update. Be patient and wait for the Hub ears to turn green. This shouldn't take longer than 2 minutes. Once the firmware update is complete the Hub will need to reboot. At this point you will see the setup light sequence - **see page 10**.

Slow notifications

If you find some messages are slow to appear on your app, this is likely because your Hub is having to work hard to connect to your Microchip Pet Feeder Connect. To improve the speed of messages, try moving your Hub to a better location following the advice given on **page 9**.

Microchip Pet Feeder Connect

If there are any mechanical issues with your Feeder, please do not try and fix these yourself. Instead, contact our friendly customer service team - see **back cover** for contact details.

The Feeder won't open for my pet

- Ensure the 4 x sensors inside the hoop are clean - **see page 21**.
- Check that you used good quality **alkaline** batteries and that they are not running low. Ensure the + and - of the batteries are in the correct orientation - **see page 11**.
- Move the Feeder away from any metallic or electrical appliances. If the Feeder still won't open for your authorised pet, continue reading.
- Check that there are no obvious sources of electrical noise in the area i.e. faulty flickering lights, etc. If you suspect there are, please call our customer care team - **see the back cover for details**.
- If the above doesn't work, check with your vet to ensure that your pet's microchip is working and that it is located in the normal place. If it has moved significantly, it will have become hard to read. In the meantime you could use the Sure Petcare RFID Collar Tag provided. Attach the collar tag to your pet's collar and repeat the 'Add a pet' process - **see pages 15**.

My pet is not happy using the Feeder

- Repeat the training process allowing more time for your pet to feel comfortable between each step - **see page 19-20**.
- If your pet is still very cautious of the Feeder then try following the steps at **surepetcare.com/cautiouspet** ensuring you don't try to force your pet to feed at any point.
- Assess your pet's feeding environment. Do they always approach their bowl from a set angle? Are they worried about having their back to the door? There is no set orientation that the Feeder must be placed in so, if you can, change it to help your pet feel more comfortable.
- If the time delay for the lid to close (after your pet has finished eating and stepped back) is not right for them, you can increase/decrease the time it takes to close in the Sure Petcare app.

The Feeder lid is not closing all the way

- This could be caused by food debris getting caught under the lid or in the mechanism. To ensure that the lid continues to close correctly it is important to clear food debris from the surfaces of the Feeder - **see page 21-22**.
- Make sure you are not in a training mode, **visit page 19** to learn more about training mode behaviour.

Portion indicator lights are on but the bowl is empty

If when you open the Feeder some of the portion indicator lights are green, even though there is no food left in the bowls, it highlights the need for zeroing. To solve this, make sure to always press the zero button before replacing your pet's food - **see page 17-18**.

The portion indicator lights are not responding

- Please be aware that if you haven't set a portion weight on the Sure Petcare app, the portion indicator lights will not illuminate when adding your pet's food.
- Also, debris stuck around the weighing arms can affect the performance of the Feeder, so please make sure that this area is clean - **see page 21-22**.

Other pets are stealing food

- If greedy pets are trying to steal food from an open Feeder, you can try reducing the time it takes for the lid to close after the pet has finished eating via the Sure Petcare app.
- There may be a custom setting that will help solve your specific problem. Please contact our customer care team to discuss your situation - **see back cover for contact details**.
- Alternatively, if greedy pets are managing to steal food by going around the back or the side of the Feeder (when the lid is open and the authorised pet is eating) then we have created a rear cover that will help stop such clever and determined behaviour. For more information go to **surepetcare.com/accessories**.

Short battery life

- Ensure your Feeder is clean and there is no dirt obscuring the sensors - **see page 21**.
- Ensure you have used good quality batteries and that they are fitted correctly - **see page 11**.
- Check there are no obvious sources of electrical noise in the area (i.e. faulty flickering lights, etc). If you suspect there are, please call our customer care team. See **back cover** for details.

Multiple Feeders in one household

- If you find that you or your pets get confused by which Feeder is theirs, try using different coloured bowls as well as more distinctly separate feeding locations. This should help with this. Different coloured bowls and mats are sold separately. For more information go to **surepetcare.com/accessories**.

Still in need of assistance?



- If you keep having connectivity issues please visit: **surepetcare.com/hub-connectivity**
 - For more guidance, videos and customer help forums visit: **surepetcare.com/support**
 - If you're having issues with your Sure Petcare app please visit: **surepetcare.com/apphelp**
- Or you can contact our friendly customer care team. **Please see the back cover for details.**



Warranty & disclaimer

Warranty: The SureFeed Microchip Pet Feeder Connect carries a 3-year warranty from the date of purchase, subject to proof of purchase date. The warranty is restricted to any fault caused by defective materials, components or manufacture. This warranty does not apply to products whose defect has been caused by normal wear and tear, misuse, neglect or intentional damage. In the event of a part failure due to faulty parts or workmanship, the part will be replaced free of charge during the warranty period only. At the manufacturer's discretion, a replacement product may be provided free of charge in the case of a more serious malfunction. Your statutory rights are not affected.

Disclaimer: The Microchip Pet Feeder Connect and app report pet food consumption by detecting a pet's microchip ID and then measuring the weight of the bowl before and after they finish eating. In most cases this will give reliable pet food consumption data, however unexpected or unusual use of the Feeder (i.e. a pet removing the bowl or playing with food) may lead to unreliable information. Sure Petcare cannot accept liability for any damage, harm or inconvenience which may be incurred as a result of incorrect reporting of pet food consumption.

The SureFeed Microchip Pet Feeder Connect incorporates selective access features which have been designed to minimise the risk of pets eating each other's food. However, it is not possible to fully guarantee the exclusion of all other pets in all circumstances. In the rare event of an unauthorised pet gaining access to the Feeder, Sure Petcare cannot accept liability for any damage or inconvenience which may be incurred.



Disposal of Products and used Batteries: This icon indicates products subject to the following legislation:

The Waste Electrical and Electronic Equipment Directive 2012/19/EU (WEEE Directive) & The Battery Directive 2006/66/EC (as amended 2013/56/EU) requires households to dispose of EEE products and waste batteries that have reached the end of their life in an environmentally responsible manner. To reduce the impact on the environment these cannot be placed in household waste bins and must be recycled at an appropriate recycling facility. Further information on recycling can be found at: www.recycle-more.co.uk.

Ensure batteries are replaced before the expiry date shown on the battery or the battery packaging and disposed of safely and appropriately.

In case of battery leaks, wear appropriate protective clothing to protect yourself from any exposure to harmful chemicals before disposing of the batteries and cleaning up any spillage. When cleaning up a spillage avoid contact with skin. Battery chemicals shouldn't be placed near the eyes or ingested. Contact a medical professional immediately if this should occur.

FCC compliance: This device complies with Part 15 of the FCC Rules. Operation is subject to the following two conditions:

- (1) this device may not cause harmful interference, and
- (2) this device must accept any interference received, including interference that may cause undesired operation.

Changes or modifications not expressly approved by the party responsible for compliance could void the user's authority to operate the equipment. This device has been designed and complies with the safety requirements for RF exposure in accordance with FCC rule part §2.1093 and KDB 447498 D01.

IC compliance: CAN ICES-3(B)/NMB-3(B): This device complies with Industry Canada license-exempt RSS standards. Operation is subject to the following two conditions:

- (1) this device may not cause interference, and
- (2) this device must accept any interference received, including interference that may cause undesired operation of the device.

To meet RF exposure guidelines, a separation distance of 200 mm should be maintained. This device complies with the safety requirements for RF exposure in accordance with RSS-102 Issue 5 for portable use conditions.

Conformité IC: CAN ICES-3(B)/NMB-3(B): Le présent appareil est conforme aux CNR d'Industrie Canada applicables aux appareils radio exempts de licence. L'exploitation est autorisée aux deux conditions suivantes:

- (1) l'appareil ne doit pas produire de brouillage, et
- (2) l'utilisateur de l'appareil doit accepter tout brouillage radioélectrique subi, même si le brouillage est susceptible d'en compromettre le fonctionnement.

Pour respecter les consignes d'exposition aux RF, une distance de séparation de 200 mm doit être maintenue. Cet appareil est conforme aux exigences de sécurité concernant l'exposition aux RF selon la norme RSS-102, 5^{ème} édition, pour des conditions d'utilisation portable.

Trademarks: Google Play and the Google Play logo are trademarks of Google Inc. Apple, is a trademark of Apple Inc., registered in the U.S. and other countries. App Store is a service mark of Apple Inc., registered in the U.S. and other countries. IOS is a trademark or registered trademark of Cisco in the U.S. and other countries and is used under license.



SURE[™]
PETCARE

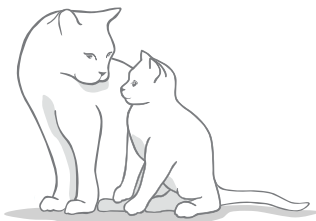

Herzlichen Glückwunsch zum Kauf Ihres neuen SureFeed Mikrochip Futterautomat Connect

Vielen Dank, dass Sie sich für den Mikrochip Futterautomat Connect entschieden haben!

Das Mikrochip Futterautomat Connect-System besteht aus drei Elementen, die zusammenwirken, um Sie mit Ihrem Haustier in Verbindung zu halten und Ihnen ein besseres Verständnis seiner Fressgewohnheiten zu ermöglichen.

Der **Mikrochip Futterautomat Connect** bildet die Hauptkomponente des Systems. Dieser erkennt den bereits implantierten Mikrochip Ihres Haustiers oder den Sure Petcare RFID-Halsbandanhänger (ein Anhänger liegt bei), sodass Ihr Liebling stets Zugang zu seinem Futterplatz hat, andere aber nicht.

Der **Hub** (separat erhältlich) ist das Verbindungselement des Systems. Er verbindet sich mit dem Internet bei Ihnen daheim und kann sowohl mit dem Futterautomaten als auch mit der Sure Petcare App kommunizieren.

Mit der **Sure Petcare App** können Sie die Futtermenge, die Ihr Haustier verzehrt, sowie die Häufigkeit, mit welcher es den Futterautomaten aufsucht, überwachen. Über die App können Sie das gewünschte Gewicht einer Portion im Futterautomaten einstellen und somit die Futtermenge pro Mahlzeit genau bestimmen.

Im Lieferumfang enthalten

Vergewissern Sie sich bitte, dass diese Teile beiliegen.**

- 1 Mikrochip Futterautomat Connect
- 2 Einzelschale
- 3 2 Halbschalen
- 4 1 Matte
- 5 1 Halterung für Einzelschale
- 6 2 Halterungen für Halbschale
- 7 1 Sure Petcare RFID-Halsbandanhänger

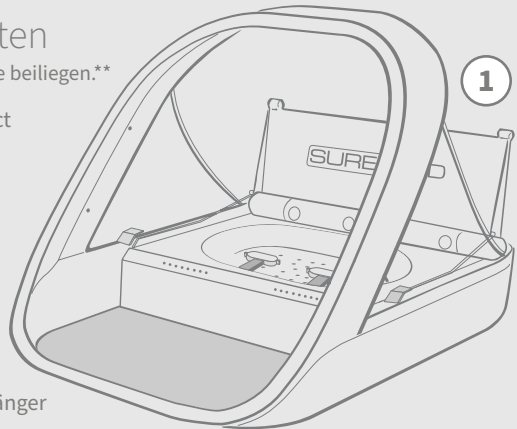

Damit Ihr Mikrochip Futterautomat Connect als Connect-System funktioniert, müssen Sie einen dazugehörigen Hub erwerben. Weitere Informationen zum Erwerb eines Hubs finden Sie unter [surepetcare.com/hub](https://www.surepetcare.com/hub)

Inhalt

Wichtige Informationen	31
Produktübersicht	33
Mikrochip Futterautomat Connect-System	35
Hub	
Einrichtung Ihres Hubs	36
Aufstellort für Ihren Hub	37
Hub-LEDs	38
Futterautomat	
Batterien	39
Anschließen des Futterautomaten	40
Tasten und LED-Leuchten	41
Ihr Tier im Futterautomaten erfassen	43
Einstellen der Portionen	44
Zuteilen und Auswechseln des Futters	45
Trainingsmodus	47
Reinigung und Wartung	49
Hilfe und Support	51
Garantie und Haftungsausschluss	55

i

Wichtige Informationen



LESEN SIE DIE FOLGENDEN INFORMATIONEN SORGFÄLTIG DURCH UND BEWAHREN SIE DIESES HANDBUCH AUF, UM AUCH SPÄTER DORT NACHSCHLAGEN ZU KÖNNEN.



Dieses Produkt ist **nur für Haustiere** bestimmt.



Verwenden Sie ausschließlich SureFeed-Zubehör, um die erforderliche Kompatibilität zu gewährleisten: surepetcare.com/zubehoer



Stellen Sie sicher, dass alle auf **Seite 29** aufgeführten Teile vorliegen.



Stellen Sie den Futterautomaten nicht in Bereichen auf, an denen Personen häufig vorbeigehen.



Der Futterautomat sollte **nur in Innenräumen** aufgestellt werden.



Tauchen Sie den Futterautomaten **nicht in Wasser** und halten Sie ihn auch nicht direkt unter einen Wasserhahn.



Stellen Sie den Futterautomaten **nicht in den Kühlschrank** und legen Sie keine Eisbeutel unter oder in das Gerät.



Platzieren Sie den Futterautomaten **nicht an Stellen**, an denen er **übermäßiger Hitze** ausgesetzt ist.

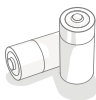

Dieses Produkt wird mit **4 Batterien des Typs C** betrieben, die vorsichtig einzusetzen bzw. auszutauschen sind. Vermeiden Sie das Mischen unterschiedlicher Batterietypen und kombinieren Sie auch keine neuen mit gebrauchten Batterien. Wenn Sie den Futterautomaten eine längere Zeit nicht verwenden möchten, entfernen Sie die Batterien.

Den **Produktcode** und die **Seriennummer** für den Mikrochip Futterautomat Connect finden Sie auf der Unterseite des Produkts.

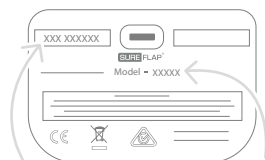

Seriennummer

Produktcode

Sicherheitshinweise

- **Verwenden Sie dieses Produkt nicht**, wenn Teile fehlen bzw. beschädigt oder verschlissen sind.
- **Bei der Herstellung dieses Artikels wurden Kleinteile verwendet.** Lose Teile stellen ein **Erstickungsrisiko** dar und sind von Kleinkindern und Haustieren **fernzuhalten**.

Sonstige wichtige Aspekte



HAUSTIERE: Sure Petcare empfiehlt, den SureFeed Mikrochip Futterautomat Connect mit dem implantierten Chip Ihres Haustiers zu verwenden. Es ist jedoch auch eine Verwendung mit dem Sure Petcare RFID-Halsbandanhänger möglich. Der Halsbandanhänger sollte nur in Verbindung mit einem Sicherheitshalsband verwendet werden, **das mit einem Sicherheitsverschluss versehen ist** (nur für Katzen). Sure Petcare kann keine Haftung für Verletzungen oder Unfälle mit Todesfolge übernehmen, die durch das Halsband eines Haustieres verursacht werden.



ZUGANG ZUM FUTTER: Sure Petcare kann keine Haftung übernehmen, wenn sich infolge unsachgemäßer Verwendung ein anderes Haustier unrechtmäßig den Zugang verschafft. Als Besitzer dieses Produkts **übernehmen Sie die volle Verantwortung für die zu überwachende Verabreichung der Futtermittel**, die bei unbeabsichtigtem Verzehr anderen Haustieren Schaden zufügen könnten.



KEINE TIMERFUNKTION: Dieses Produkt hat keinen Timer und **auch keine zeitbezogene Funktionalität**. Deshalb sollten Sie Ihr Haustier nicht unbeaufsichtigt lassen oder sich darauf verlassen, dass dieses Produkt Ihre Tiere über längere Zeiträume versorgen kann. Für Katzen bedeutet ein solcher Zeitraum nicht mehr als 24 Stunden und für kleine Hunde die durchschnittliche Zeit zwischen den Mahlzeiten. **Der Kauf dieses Produkts entbindet Sie nicht von einer verantwortungsvollen Haustierhaltung.**



KINDER: Lassen Sie Kinder **nicht mit dem SureFeed Mikrochip Futterautomat Connect spielen**. Er ist kein Spielzeug und darf daher auch nicht dafür verwendet werden. Dieses Produkt kann jedoch – unter Aufsicht – von Kindern ab 8 Jahren sowie von Personen mit eingeschränkten körperlichen, sensorischen oder geistigen Fähigkeiten bedient werden. Sie müssen allerdings stets auf mögliche Gefahren hingewiesen werden. Kinder sollten das Produkt nicht ohne Beaufsichtigung durch einen Erwachsenen reinigen.



KINDERSICHERUNG: In Haushalten mit Kindern ist der **SureFeed Mikrochip Futterautomat Connect bei Maßnahmen für die Kindersicherheit unbedingt zu berücksichtigen**. Bei unsachgemäßer Benutzung dieses Produkts durch ein Kind kann das Kind Gefahren ausgesetzt sein. Aus diesem Grund müssen Kleinkinder stets beaufsichtigt werden, wenn sie sich in unmittelbarer Nähe des Futterautomaten aufhalten. Seien Sie sich daher bewusst, dass ein Kind auch dann Zugang zum Tierfutter hat, wenn sich der Futterautomat im Trainingsmodus befindet (**siehe Seite 47**).



Produktübersicht

Das Mikrochip Futterrautomat Connect-System setzt sich aus drei Hauptkomponenten zusammen:

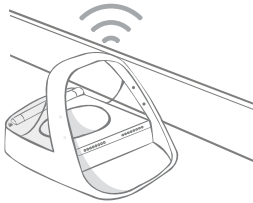

Mikrochip Futterrautomat
Connect



Hub



Sure Petcare app

Der Hub ist mittels Ethernet-Kabel mit dem Internet verbunden und überwacht drahtlos die Aktivität Ihres Mikrochip Futterrautomat Connect. Er kommuniziert sowohl mit dem Futterrautomaten als auch mit der Sure Petcare App und gibt Ihnen die Möglichkeit, alles im Auge zu behalten, selbst wenn Sie nicht zu Hause sind!

Sie können in der App auch das gewünschte Gewicht einer Portionen einstellen. Nachdem Sie dieses Gewicht bestimmt haben, werden Sie fortan vom Futterrautomaten durch den Auffüllvorgang geführt, damit Ihr Liebling auch wirklich die angemessene Portion erhält. Weitere Informationen finden Sie auf Seite 42.

Schalen und Halterungen:

siehe Seite 34.

Deckelverriegelung:

siehe Seite 41.

Sensoren: Ihr Haustier wird über vier kleine Punkte auf der Innenseite des Rahmens erkannt.

Hintere LED:
siehe Seite 41.

Matte: Entwickelt, um Futterreste zu sammeln und den Futterrautomaten leichter zu reinigen.

Tasten:
siehe Seite 41.

LED-Portionsanzeige:
siehe Seite 42.

Batteriefächer:
siehe Seite 39.
Abdeckung des Reinigungszugangs:
siehe Seite 49.

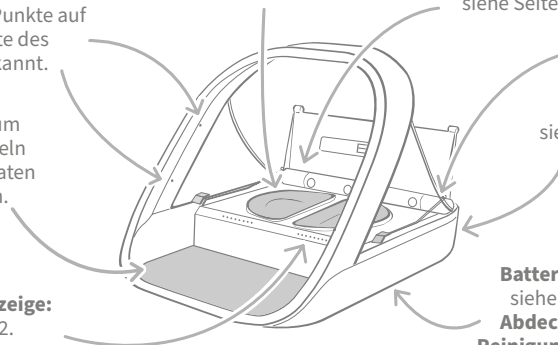

Hub-LEDs:
siehe Seite 38.

Ethernet-Anschluss:
zur Verbindung mit dem Internet-Router.

Stromversorgung:
zum Anschluss des Stromversorgungskabels.

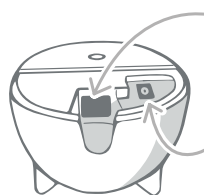

Alle SureFeed Schalen sind mit einer Gummilippe versehen, welche mit dem Deckel luftdicht abschließt und das Futter länger frisch hält. Wenn Sie ausschließlich eine Art von Futter verabreichen, können Sie die Einzelschale verwenden. Bei einer Kombination aus Nass- und Trockenfutter sind die Halbschalen besser geeignet.



Einzelschale - kann 250 g aufnehmen, was für mindestens 2 Beutel Nassfutters reicht.

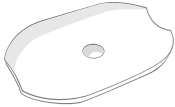

Halterung für Einzelschalen - wurde so konzipiert, dass sie eine Einzelschale (nicht Halbschale) stützt.

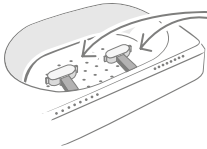

Wiegearme - zum Abstützen der Napfhalterung.



Halbschalen - jede Schale kann bis zu 100 g oder 200 g auf beide Näpfe verteilt aufnehmen.



Halterungen für Halbschalen - jede ist so konzipiert, dass sie eine Halbschale (nicht Einzelschale) stützt.

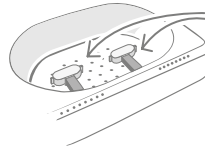

Wiegearme - zum Abstützen der Napfhalterungen.

Geben Sie das Futter Ihres Haustieres nicht direkt auf die Schalenhalterungen.

Verwenden Sie stets die Schalen, um die korrekte Funktionsweise des Futterautomaten zu gewährleisten.



Die SureFeed Split-Schale ist nicht für den Gebrauch mit dem Mikrochip Futterautomat Connect vorgesehen.

Wenn Sie weitere Schalen oder Matten erwerben möchten, wenden Sie sich an einen Sure Petcare-Fachhändler oder besuchen Sie surepetcare.com

Sorgen Sie für etwas Farbe



SureFeed Kunststoffschalen und Matten werden in vier verschiedenen Farben angeboten: blau, grün, pink und grau.

Oder für etwas mehr Glanz

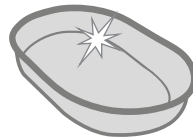

Die SureFeed Einzelschale ist auch in Edelstahl erhältlich.



Stellen Sie die Schalen nicht in die Geschirrpülmaschine oder in die Mikrowelle.



Vor der ersten Verwendung reinigen



Mikrochip Futterautomat Connect-System

Laden Sie die kostenlose Sure Petcare App jetzt herunter

LADEN IM
APP STORE

JETZT BEI
GOOGLE PLAY



surepetcare.io



Lassen Sie sich benachrichtigen, wenn Ihr Haustier aus dem Futterautomaten frisst.



Beobachten Sie die Futterraufnahme und achten Sie auf mögliche Verhaltensänderungen.



Portionieren Sie Rationen genau, um die verzehrte Futtermenge zu überwachen.



Teilen Sie den Zugang zum Haushalt mit Familienangehörigen und Freunden.



Laden Sie die **Sure Petcare App** herunter und erstellen Sie ein Konto. Sie werden aufgefordert, einen „Haushalt“ (ein verbundenes Netzwerk mit all Ihren Tieren und Sure Petcare-Produkten) zu erstellen. Sie können andere Familienmitglieder in Ihren „Haushalt“ aufnehmen.

Um die App herunterzuladen zu können, muss auf Ihrem Smartphone oder Tablet mindestens **iOS 9** auf **Apple** oder **4.4** auf **Android** installiert sein.



Wenn Sie Ihre angeschlossenen Sure Petcare-Produkte lieber über einen Computer steuern möchten, können Sie auch die Sure Petcare Web App unter **surepetcare.io** verwenden.

Sie benötigen die neueste Version von **Safari**, **Chrome**, **Firefox** oder **Internet Explorer** unter **Mac OS X 10.9** (oder neuer) bzw. **Windows 7** (oder neuer).

Kauf eines Sure Petcare Hubs



Wenn Sie Ihren Mikrochip Futterautomat Connect in Verbindung mit der Sure Petcare App verwenden möchten, benötigen Sie den dazugehörigen Hub. Weitere Informationen zum Kauf eines Hubs finden Sie unter **surepetcare.com/hub**.



Einrichtung Ihres Hubs

Nachdem Sie die Sure Petcare App heruntergeladen haben, müssen Sie Ihren Hub anschließen und einrichten. Nach der Einrichtung werden Sie aufgefordert, den Hub mit dem Futterautomaten und der App zu verbinden. Führen Sie bitte die im Folgenden beschriebenen Schritte aus:

1

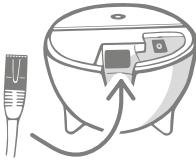

Schließen Sie ein Ende des Ethernet-Kabels an die Basis des Hubs und das andere Ende an einen freien Anschluss Ihres Routers an.

2

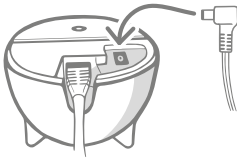

Setzen Sie das Netzteil zusammen und schließen Sie es an eine Steckdose an. Schließen Sie das andere Ende des Kabels an die Basis Ihres Hubs an.

3

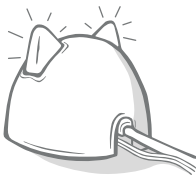

Die „Ohren“ Ihres Hubs **leuchten abwechselnd rot und grün auf**. Sobald beide Ohren ununterbrochen grün aufleuchten, ist der Hub einsatzbereit. Ist dies nicht der Fall, lesen Sie die Informationen auf **Seite 38**.

4



Um die Einrichtung Ihres Mikrochip Futterautomat Connect-Systems abzuschließen, **befolgen Sie die weiteren Schritte in der Sure Petcare App**.



Sie erhalten unter Umständen ein Software-Update für Ihren Hub. Machen Sie sich keine Sorgen, falls die Ohren während der Einrichtung **durchgehend rot** leuchten. Das bedeutet nur, dass die Software des Hubs gerade aktualisiert wird. Nach Abschluss des Vorgangs wird der Hub neu gestartet und die Ohren leuchten wie in Schritt 3 beschrieben.



Aufstellort für Ihren Hub

Da Ihr Mikrochip Futterautomat Connect-System kabellos kommuniziert, kann der Standort des Hubs dessen Leistung beeinflussen.



Stellen Sie den Hub in einer Entfernung von mindestens 1 Meter zum Boden (z. B. auf einen Tisch, der möglichst frei von Hindernissen sein sollte).

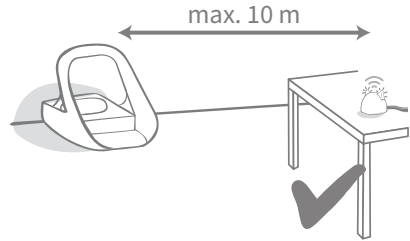

Stellen Sie den Hub nach Möglichkeit in Sichtweite und in einem Umkreis von höchstens 10 Metern zum Futter-automaten auf.

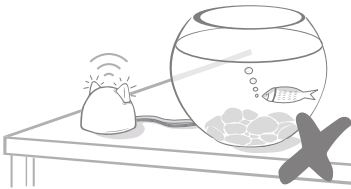

Stellen Sie ihn nach Möglichkeit nicht in der Nähe oder in Sichtweite größerer Wassermengen (z. B. Aquarien) auf.

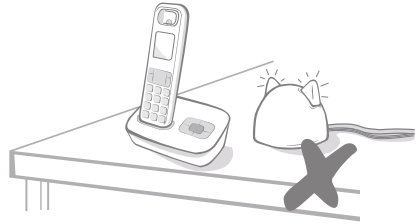

Stellen Sie den Hub möglichst weit weg von eventuellen Störungsquellen (z.B. schnurlose Telefone, Babyphone usw.) auf.

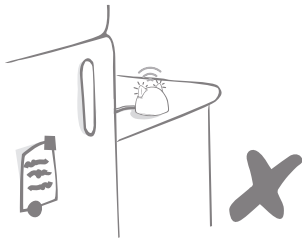

Stellen Sie sicher, dass er sich nicht in der Nähe großer Metallobjekte wie Kühlschränken befindet.

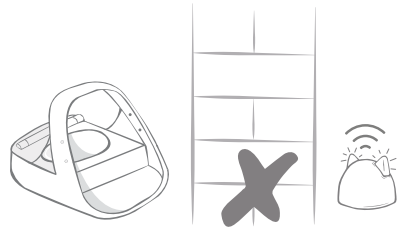

Es sollten sich keine dicken Wände zwischen dem Hub und dem Futterautomaten befinden.



Gelegentlich kann es bei Ihrem Hub zu Verbindungsproblemen kommen, auch wenn Sie sich an die oben aufgeführten Tipps gehalten haben. Unter surepetcare.com/hub-connectivity finden Sie weitere Informationen dazu, wie Sie den Abstand zwischen dem Hub und dem Mikrochip Futterautomat Connect verringern können.



Falls die Internetverbindung Ihres Hubs aus irgendeinem Grund unterbrochen wird, funktioniert der Mikrochip Futterautomat Connect dennoch wie gewohnt und die Einstellungen bleiben erhalten.



Hub-LEDs

Die LEDs in den Ohren des Hubs zeigen dessen aktuellen Status an. Dabei stehen die unterschiedlichen Leuchtsequenzen für verschiedene Zustände.

Einrichtungs-LEDs

Jedes Mal, wenn der Hub eingeschaltet wird oder er sich mit anderen Elementen des Systems verbindet, leuchten die Einrichtungs-LEDs auf:

1

Die Ohren leuchten zunächst **abwechselnd rot**



2

und **dann grün** auf.



3

Dann leuchten sie **kurz orange** und anschließend **durchgehend grün**. Ihr Hub ist nun verbunden.



Grüne Ohren

Grüne Ohren zeigen an, dass der Hub korrekt funktioniert. Nachfolgend sind die Bedeutungen der einzelnen Sequenzen beschrieben.

Beide Ohren leuchten durchgehend grün – Ihr Hub ist eingeschaltet, verbunden und funktioniert ordnungsgemäß.

Abwechselnd grün leuchtende Ohren – Ihr Hub verbindet sich erneut mit unseren Servern.

Rote Ohren

Beide Ohren leuchten durchgehend rot – Die Software Ihres Hubs wird gerade aktualisiert. Haben Sie etwas Geduld. Ihr Hub wird in Kürze neu gestartet und funktioniert dann wie gewohnt.

Beide Ohren blinken rot – Die Verbindung zwischen dem Hub und dem Futterautomaten ist abgebrochen und der Hub versucht, diese wiederherzustellen.

Abwechselnd rot leuchtende Ohren – Ihr Hub hat Probleme bei der Verbindung mit dem Internet bzw. den Servern.



Weitere Informationen zur Diagnose dieser Probleme **finden Sie auf Seite 52**.



Batterien

Verwenden Sie stets **4 hochwertige 1,5 V-Alkali-Batterien vom Typ C**. So bleibt die Funktionsfähigkeit Ihres Mikrochip Futterautomat Connect optimal gewährleistet. Dieses **Produkt ist NICHT für die Verwendung mit wiederaufladbaren Akkus vorgesehen**. Führen Sie bitte die im Folgenden beschriebenen Schritte durch, um Batterien einzusetzen oder zu wechseln:



In der Nähe der Rückseite des Futterautomaten befindet sich eine LED. Ist der Batteriestand niedrig oder wurden die Batterien nicht ordnungsgemäß eingesetzt, dann leuchtet diese LED alle 5 Sekunden rot auf.

1

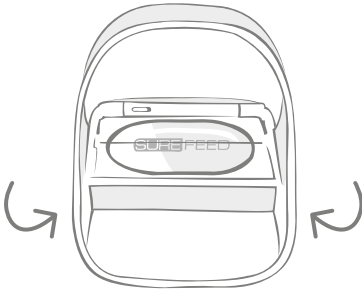

Stellen Sie den Futterautomaten auf den Kopf, um an das Batteriefach zu gelangen.

2

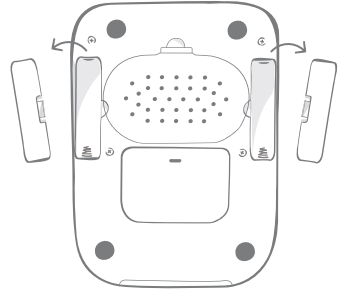

Entfernen Sie die Batteriefachdeckel.

3

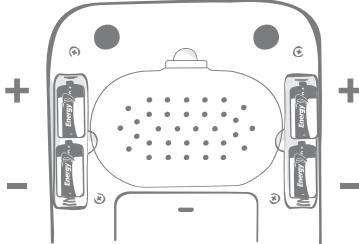

Legen Sie die Batterien ein. Achten Sie darauf, dass die (+/-)-Symbole auf den Batterien auf die Symbole auf dem Automaten ausgerichtet sind.

4

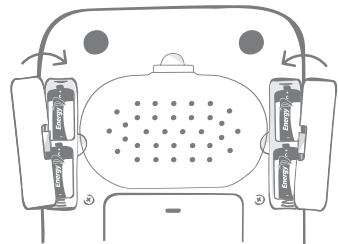

Setzen Sie die Batteriefachdeckel wieder ein.



Sobald Sie die Mikrochip-ID Ihres Haustieres im Futterautomaten programmiert haben, bleibt sie dauerhaft gespeichert. Das bedeutet, dass der Futterautomat auch nach einem Batteriewechsel Ihr registriertes Haustier erkennt.



Anschließen des Futterautomaten

Um die Einrichtung des Connect-Systems abzuschließen, müssen Sie den Futterautomaten mit dem Hub verbinden.

1

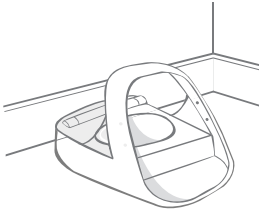

Platzieren Sie den Futterautomaten an der vorgesehenen Stelle. Damit soll sichergestellt werden, dass er mit dem Hub kommunizieren kann.

2



Wählen Sie auf der Sure Petcare App „**Produkt hinzufügen**“ aus.

3



Ihr Hub wechselt in den Verbindungsmodus und die Ohren beginnen, grün zu leuchten.

4

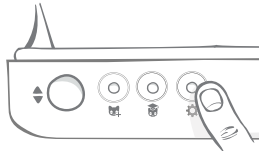

Drücken Sie die Einstelltaste „**⚙**“ auf dem Futterautomaten einmal. Die Ohr-LED leuchtet grün.

5

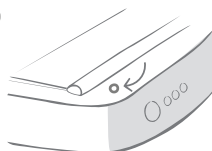

Sobald der Futterautomat angeschlossen ist, erlischt die LED und der Hub hört auf zu blinken.

i

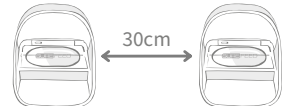

Wenn Sie mehrere Futterautomaten anschließen möchten, können Sie dies ganz einfach über die App tun.

Hinzufügen des Futterautomaten zu Ihrem aktuellen „Haushalt“



Sie können einen Mikrochip Futterautomat Connect über die App zu Ihrem bestehenden Sure Petcare-Haushalt hinzufügen. Gehen Sie zum Abschnitt „Haushalt“ und folgen Sie den obigen Anweisungen.

Sie können die Mikrochip-ID Ihres Haustieres auch ferngesteuert über die App zuweisen. Das bedeutet, dass Sie sie nicht mehr von Hand hinzufügen müssen. Haustiere mit Hilfe von Leckerli zu erfassen, kann sie jedoch ermuntern, das neue Gerät anzunehmen. Weitere Informationen zum Erfassen von Haustieren finden Sie unter **siehe Seite 43**.



Tasten und LED-Leuchten

Tasten

Es gibt 5 Tasten auf dem Futterautomaten. Diese befinden sich auf der Rückseite des Produkts:

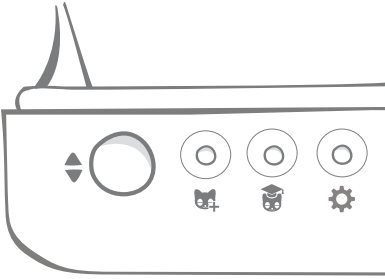

Taste „Auf-/Zu“ – öffnet und schließt den Deckel, sodass Sie Zugang zu den Schalen haben.



Taste „Haustier hinzufügen“ – Mit dieser Taste speichern Sie den Mikrochip Ihres Haustiers - **siehe Seite 43**.



Taste für den Trainingsmodus – mit dieser Taste gewöhnen Sie Ihr Tier an den Umgang mit dem Futterautomaten - **siehe Seite 47-48**.



Taste „Einstellungen“ – wird für den Anschluss des Automaten an den Hub verwendet - **siehe Seite 40**.



Taste „Null“ - wird verwendet, um den Futter-automaten zu kalibrieren, und um sicherzustellen, dass Sie die richtige Futtermenge einfüllen - **siehe Seite 45**. Diese Taste setzt beide Seiten des Futterautomaten auf Null, **unabhängig davon, ob Sie eine Einzel- oder eine Halbschale verwenden**.



Wenn Sie Halbschalen verwenden und diese auf Null zurücksetzen möchten, können Sie dies mithilfe der **Sure Petcare App** tun.

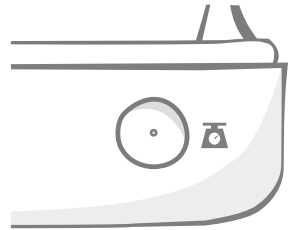

Deckelverriegelung



Verriegelt - Das bedeutet, dass Sie den Deckel des Futterautomaten nicht herausziehen und entfernen können.



Entsperrt - Sie können den Deckel in geöffneter Position herausziehen, um ihn zu entfernen.

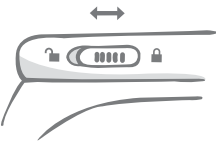
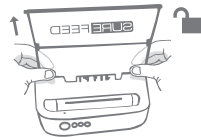

Die Deckelverriegelung sollte stets **verriegelt bleiben** und nur dann entriegelt werden, wenn Sie den Deckel zur Reinigung entfernen möchten. Auf diese Weise können Sie verhindern, dass sehr clevere, nicht gespeicherte Haustiere versuchen, den Deckel zu entfernen, um sich Zugang zum Futter zu verschaffen. **Beachten Sie, dass dadurch das Öffnen des Deckels nicht verhindert wird.**

Hintere LED

Leuchtet konstant grün. Das grüne Licht leuchtet jedes Mal auf, wenn ein gespeichertes Haustier aus dem Futterautomaten frisst.

Grünes Licht blinkt. Der Futterautomat befindet sich im Modus „Haustier hinzufügen“ - **siehe Seite 43**. Das Licht blinkt weiter, bis ein Mikrochip hinzugefügt wird oder bis Sie den Modus wieder verlassen.

Orangefarbenes Licht blinkt. Der Futterautomat befindet sich im Trainingsmodus - **siehe Seite 47-48**. Die Anzahl der Blinksignale bezieht sich auf die Trainingsphase.

Rotes Licht blinkt. Die Batterien sind fast leer.

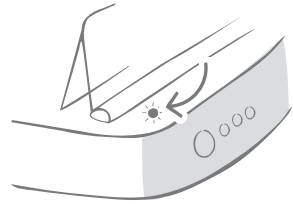

LED-Portionsanzeige

Wenn Sie in der Sure Petcare App ein Portionsgewicht festgelegt haben, dienen die Lichter auf der Vorderseite des Futterautomaten als Orientierungshilfe beim Einfüllen von Futter.

Die Portionsanzeige gibt die Futtermenge an, die Sie eingefüllt haben, damit Sie sicherstellen können, dass Ihr Haustier die richtige Portion erhält.

Weitere Informationen über die Vorteile einer genauen Portionierung finden **Sie unter 44**.

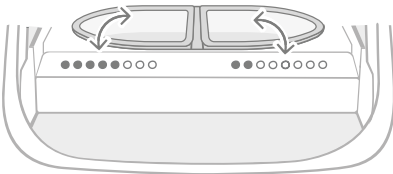
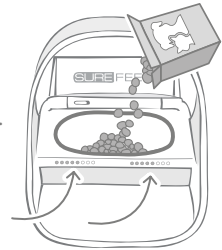

Gebrauch der Halbschalen

Die Lichter auf der rechten Seite des Futterautomaten entsprechen der Schale auf der rechten Seite, was umgekehrt für die linke Seite gilt. Die LEDs leuchten auf, wenn auf beiden Seiten Futter hinzugegeben wird.

Gebrauch der Einzelschale

Beide LED-Reihen leuchten gleichzeitig auf, wenn Futter in den Einzelnapf gegeben wird.

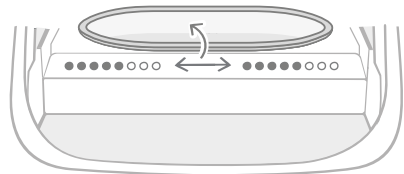

Wenn Sie von einer Halbschale zu einer Einzelschale oder umgekehrt wechseln möchten, müssen Sie die Umstellung über die Sure Petcare App vornehmen.



Wenn Sie in der App kein Portionsgewicht eingestellt haben, leuchten die Lichter nicht auf, wenn Futter in den Automaten gefüllt wird.



Ihr Tier im Futterautomaten erfassen

Wenn Sie die Mikrochip-ID Ihres Haustieres in den Mikrochip Futterautomat Connect eingeben, achten Sie darauf, dass sich alle anderen Haustiere und nicht benötigten Halsbandanhänger in einem angemessenen Abstand befinden.

1

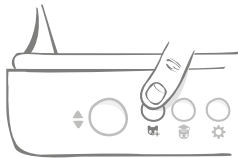

Drücken Sie die Taste „Haustier hinzufügen“ (🐾) auf der Rückseite des Futterautomaten.

2

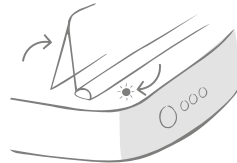

Die Abdeckung öffnet sich und die LED blinkt im Sekundentakt grün.

3

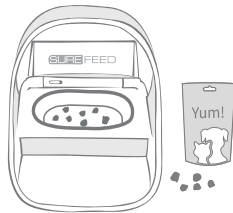

Geben Sie Futter/Leckerlis in die Schale und platzieren Sie den Futterautomaten an der gewohnten Futterstelle Ihres Haustiers.

4



Während Ihr Haustier frisst, scannt der Futterautomat dessen Mikrochip-ID. Sobald die ID registriert wurde, **hört die LED auf zu blinken** (bleibt aber an).

5

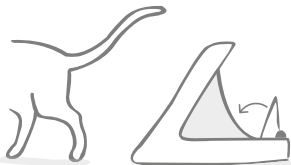

Wenn das Tier sich vom Futterautomaten entfernt, schließt die Abdeckung automatisch, und die grüne LED erlischt. Ihre Mikrochip-ID ist nun dauerhaft gespeichert.

i



Bei Bedarf können Sie den Modus „Haustier hinzufügen“ jederzeit durch erneutes Drücken der Taste „Haustier hinzufügen“ (🐾) beenden.



Um die Mikrochip-ID eines Haustieres zu speichern, müssen die Sensoren, die sich in der Öffnung des Futterautomaten befinden, die Anwesenheit des Haustieres erkennen. Deshalb ist es wichtig, dass Ihr Haustier zum Fressen den Kopf durch die Öffnung steckt.



Um einen Sure Petcare RFID-Halsbandanhänger zu programmieren, befolgen Sie einfach die oben aufgeführten Schritte, halten Sie aber den Anhänger dabei in die Öffnung hinein. Tragen Sie beim Speichern des Halsbandanhängers keinen Schmuck aus Metall.



Wenn Sie bereits ein Haustier in Ihrem Sure Petcare-Haushalt haben, kann dieses dem Futterautomaten zugewiesen werden. Gehen Sie zum Abschnitt „Haushalt“ der App. Sollten Sie versehentlich das falsche Tier registriert haben, können Sie den Fehler jederzeit hier korrigieren.



Einstellen der Portionen

Der Mikrochip Futterrautomat Connect überwacht nicht nur, wann und was Ihr Haustier gefressen hat. Er kann Ihnen auch bei jeder Fütterung mit der genauen Portionierung helfen.

Warum sollten Sie das Futter portionieren?

Könnte Ihr Tier davon profitieren, ein wenig an Gewicht zu verlieren? Durch das Festlegen des Portionsgewichts können Sie sicherstellen, dass Sie ihm nicht versehentlich zu viel Futter pro Tag verabreichen. Das summiert sich schließlich!

Die Möglichkeit, Futterportionen direkt im Automaten abzuwiegen, macht es schneller, einfacher und bequemer, dafür zu sorgen, dass Ihr Haustier die angemessene Menge frisst.

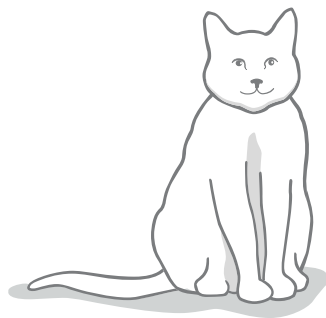

Wie viel Futter sollten Sie Ihrem Tier zugestehen?

Die jeweils angemessene Futtermenge zu ermitteln, kann sich als schwierig erweisen, vor allem, wenn die Auswahl groß ist. Wir empfehlen Ihnen daher, Ihren Tierarzt oder Tiergesundheitsberater um Rat zu fragen.

Orientieren Sie sich anderenfalls an den Empfehlungen auf der Verpackung der Futtermittelherstellers. Diese Informationen sind normalerweise ein guter Leitfaden für typische, gesunde Haustiere.

So stellen Sie das Portionsgewicht in der App ein

Sie können das Portionsgewicht in der Sure Petcare App einstellen. Einmal eingestellt, wird die Menge an den Futterrautomaten gesendet, damit dieser weiß, wie viel Futter Sie dem Tier pro Fütterung zukommen lassen wollen.

Die Portionsanzeigen auf dem Automaten leiten Sie durch die Futterrationierung, damit stets die angemessene Menge verabreicht wird. Die LEDs zeigen die Menge des zugeteilten Futters an, **siehe Seite 46** für weitere Informationen.





Zuteilen und Auswechseln des Futters

Es ist wichtig, dass Sie das Futter täglich auswechseln: Nur so können Sie sichergehen, dass Ihr Liebling gesund und munter bleibt und der Futterautomat weiterhin hygienisch einwandfrei funktioniert.

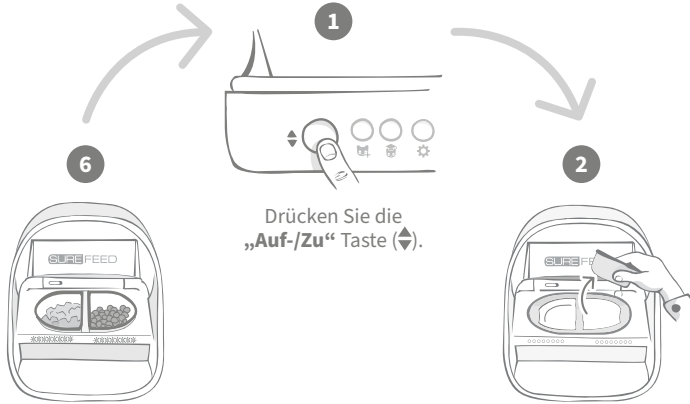

Drücken Sie die „Auf-/Zu“ Taste (↕).

Wenn alle Lichter grün blinken, haben Sie die Schale mit der korrekten Menge befüllt.

Entfernen Sie die verschmutzten Schalen sowie eventuelle Futterrückstände. Reinigen Sie sie oder ersetzen Sie sie durch saubere.



Nachdem die LED-Portionsanzeige auf Null zurückgesetzt wurde, können Sie mit dem Befüllen der Schalen beginnen. Die Portionsanzeigen leuchten auf, um die Menge der Rationen in jeder Schale anzuzeigen - siehe nächste Seite.

Achten Sie darauf, dass die entsprechenden Halterungen der Einzel- oder Halbschalen an den Wiegearmen korrekt angebracht sind und **platzieren Sie eine leere Schale darauf**.

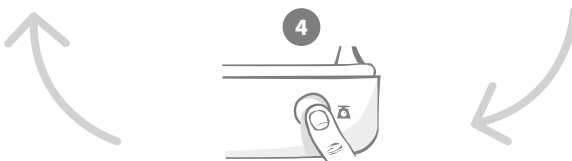

Drücken Sie die Taste „Null“, bevor Sie die Schalen auffüllen, um sicherzustellen, dass Sie Ihrem Haustier eine volle Portion zuteilen. Vergessen Sie nicht, dass durch das Drücken dieser Taste **beide Seiten des Futterautomaten auf Null zurückgesetzt werden** - siehe Seite 41.

Portionsanzeige leuchtet



LED-Portionsanzeige auf Null zurücksetzen:

Von links nach rechts abnehmende grüne Lichter leuchten, wenn Sie die Taste „Null“ drücken.



Zuteilen von Futter:

Wird Futter hinzugegeben, leuchten die LEDs der Portionsanzeige grün auf, von links nach rechts zunehmend. Die Lichter entsprechen der Futtermenge im Napf. Sie müssen so viel Futter hinzugeben, bis alle LEDs aufleuchten.



Das Gewicht der Portion erreichen:

Wenn Sie sich innerhalb von +/- 1 g des gewünschten Portionsgewichts befinden, **blinken die Lichter grün**. Wenn die Lichter nicht blinken, ist es noch keine volle Portion.



Überfüllung:

Wenn Sie mehr als das Gewicht der Portion in die Schale geben, werden Sie durch die roten Lichter darauf hingewiesen, dass die Portion überdimensioniert ist. Entnehmen Sie dann einfach wieder einen Teil des Futters, bis Sie die blinkenden grünen Lichter sehen.



Sollten Sie in der App kein Portionsgewicht eingestellt haben, **leuchten die Lichter nicht auf**, wenn der Futterautomat befüllt wird.

Futterreste im Napf?

Sollte sich vor den Abendessen noch immer Futter in der Schale befinden, müssen Sie die Taste „Null“ nicht drücken. Sie können einfach die neue Portion auf die Reste geben und der Futterautomat wird diese neue Portion ergänzen lassen. Die LED-Portionsanzeige wird Sie eine ganze Portion hinzufügen lassen und diese entsprechend anzeigen.

1

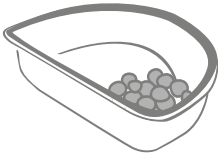

Wenn Sie den Deckel öffnen, werden die LEDs teilweise aufleuchten, um zu signalisieren, dass noch etwas Futter in der Schale ist. Diese werden im Anschluss erlöschen, damit Sie die frische Ration entsprechend portionieren und ergänzen können.

2

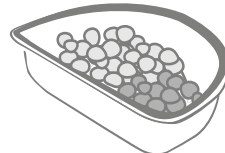

Füllen Sie den Napf auf, bis alle Lichter der Portionsanzeige grün blinken.



Trainingsmodus

(macht Ihr Tier mit dem Futterautomaten vertraut)



Wenn der Deckel durch die „Auf-/Zu“ Taste geöffnet wurde, wird die orangefarbene LED rot aufblinken, um zu signalisieren, dass die „Auf-/Zu“ Taste gedrückt wurde und sich der Automat im offenen Modus befindet. Sobald das Futter hinzugefügt wurde und die „Auf-/Zu“ Taste erneut gedrückt wurde, wird die LED wieder orange aufleuchten. **Wenn Sie die „Auf-/Zu“ Taste nicht drücken, werden die LEDs der Portionsanzeige nicht aktiviert und das System kann Sie nicht erkennen, wenn Sie Futter auffüllen.**

TEIL 1 – Erste Schritte mit dem Futterautomaten

Einige Haustiere benötigen möglicherweise einige Zeit, um sich an den Futterautomaten zu gewöhnen. Mithilfe des Trainingsmodus bewegt sich die Abdeckung nach und nach immer etwas weiter, damit Ihr Tier allmählich seine Scheu vor dem Gerät verliert. Das kann sicher etwas dauern, aber haben Sie Geduld und fahren Sie erst mit **TEIL 2** fort, wenn es den Automaten angenommen hat.

1

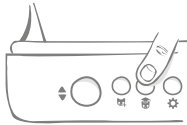

Drücken Sie bei geschlossener Abdeckung einmal die Taste für den Trainingsmodus (🗲) an der Rückseite des Futterautomaten. Die Abdeckung öffnet sich und die hintere LED blinkt im Abstand von wenigen Sekunden orange auf.

2

Befüllen Sie den Automaten mit dem Lieblingsfutter Ihres Haustiers und stellen Sie ihn am gewohnten Platz oder an einer Stelle auf, die Ihr Vierbeiner gern zum Fressen aufsucht.

3



Während dieser ersten Phase, in der Ihr Haustier den Umgang mit dem Automaten erlernt, **bleibt die Abdeckung offen**, nachdem es etwas gefressen und sich wieder entfernt hat.



Lassen Sie Ihrem Haustier genügend Zeit, sich an den neuen Futterautomaten zu gewöhnen. Sobald dies geschehen ist, gehen Sie zu TEIL 2 über.

TEIL 2 - Gewöhnung an die sich bewegende Abdeckung

Durch ein allmähliches Intensivieren dieser Bewegung kann sich Ihr Haustier über drei Phasen hinweg daran gewöhnen. Wir möchten noch einmal betonen, dass Sie in diesem Prozess die nötige Geduld aufbringen und Ihrem Haustier genügend Zeit einräumen sollten. Die Dauer der jeweiligen Phasen (Tage oder Wochen) hängt vom jeweiligen Haustier ab, wir empfehlen jedoch, für jede einzelne einige Tage einzuplanen.

4

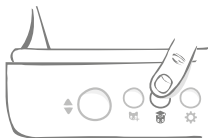

Drücken Sie die Taste für den „Trainingsmodus“ (🗲) erneut, damit sich die Abdeckung stärker bewegt. Die Abdeckung schließt sich ein wenig und die hintere LED blinkt zweimal orange auf.

5

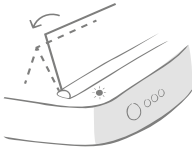

Frisst Ihr Haustier nun aus dem Automaten, bewegt sich die Abdeckung leicht, um sich schließlich ganz zu öffnen. Nach der Fütterung schließt sie sich etwas.

6



Lassen Sie Ihrem Haustier die nötige Zeit, um sich an die neue Bewegung der Abdeckung zu gewöhnen. Wenn Sie Futter nachfüllen möchten, tun Sie dies wie **auf Seite 45** beschrieben. Drücken Sie anschließend die „Auf-/Zu“ Taste (⬆), damit die Abdeckung sich wieder bis zur Trainingsposition schließt.



Lassen Sie sich und Ihrem Tier auch hier wieder genügend Zeit. Gehen Sie nicht zur nächsten Phase über, bevor sich das Tier nicht an die zusätzliche Bewegung gewöhnt hat.

7

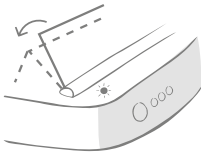

Drücken Sie die Taste für den Trainingsmodus (🐾) erneut, wenn es schließlich damit vertraut ist. Die Abdeckung schließt sich etwas weiter und nimmt die nächste Position ein, wobei die hintere LED nun drei Mal orange aufblinkt.



Drücken Sie die Taste für den Trainingsmodus (🐾) erneut, wenn es schließlich damit vertraut ist. Die Abdeckung schließt sich etwas weiter und nimmt die nächste Position ein, wobei die hintere LED nun drei Mal orange aufblinkt.

8

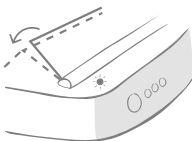

Es sollte sich nun so weit an die Bewegung der Abdeckung gewöhnt haben, dass diese in dieser letzten Trainingsphase noch weiter geschlossen werden kann. Drücken Sie wie bisher erneut die Taste „Trainingsmodus“ (🐾). Die Abdeckung schließt sich nun noch weiter und nimmt die letzte Position ein und die hintere LED blinkt vier Mal orange auf.

9



Sobald es sich an diese letzte Position der Abdeckung gewöhnt hat, drücken Sie wieder (🐾). Die Abdeckung schließt sich nun vollständig und die hintere LED hört auf zu blinken. Der Futterautomat ist nun verschlossen und bereit für den täglichen Gebrauch.



Sie können das Training jederzeit beenden, indem Sie die Taste für den Trainingsmodus (🐾) **5 Sekunden** lang gedrückt halten.



Sollten Sie wieder einen Schritt zurückgehen müssen, lesen Sie den Hinweis weiter oben. Dies beendet den Trainingsmodus und Sie können den Vorgang erneut beginnen.



Wenn Sie den Eindruck haben, dass Ihr Haustier dem Schließen der Abdeckung mit Argwohn begegnet, nachdem es sich vom Automaten entfernt hat, können Sie in der Sure Petcare App die Zeit bis zum Schließen der Abdeckung verlängern.



Reinigung und Wartung

Es ist wichtig, dass Sie den Mikrochip Futtermat Connect für Haustiere regelmäßig reinigen, damit er zuverlässig funktioniert. **Tauchen Sie das Gerät NICHT in Wasser und halten Sie es auch nicht direkt unter fließendes Wasser! Wasser kann Schäden am Futtermat und dessen Elektronik verursachen.**

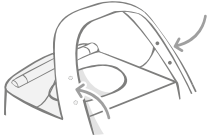
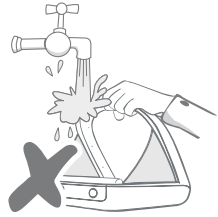

Achten Sie darauf, dass die vier schwarzen Punkte am Ring sauber bleiben und somit ordnungsgemäß funktionieren können. Die Matte kann mit einem feuchten Tuch abgewischt werden. **Reinigen Sie Teile nicht im Geschirrspüler. Säubern Sie nur von Hand.**

An der Unterseite des Mikrochip Futtermat Connect befindet sich die **Abdeckung des Reinigungszugangs**, um das Entfernen von Krümeln oder Ablagerungen zu erleichtern.

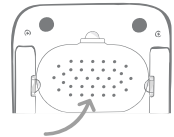

So entfernen Sie den Deckel vor der Reinigung



6
Klappen Sie nun die obere Hälfte des Deckels wieder um, sodass er auf den Deckelführungen liegt.

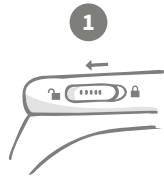

1
Bringen Sie den Schieber der Deckelverriegelung in die entriegelte Position.



2
Drücken Sie die Taste (⬇️). Sobald der Deckel geöffnet ist, ziehen Sie ihn nach oben.

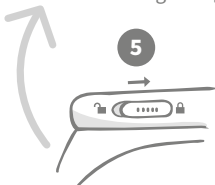

5
Bringen Sie den Schieber der Deckelverriegelung wieder in die verriegelte Position.

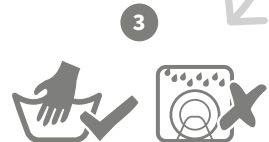

3
Säubern Sie nur von Hand. **Stellen Sie ihn nicht** in den Geschirrspüler.



4
Setzen Sie nach dem Reinigen den Deckel wieder ein. Halten Sie dabei beide Hälften senkrecht & vergewissern Sie sich, dass der Deckel fest sitzt.

So stellen Sie sicher, dass Ihr Futtermat sauer bleibt

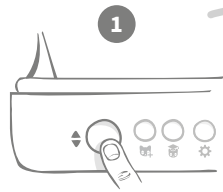

Drücken Sie die „Auf-/Zu“ Taste (↕).

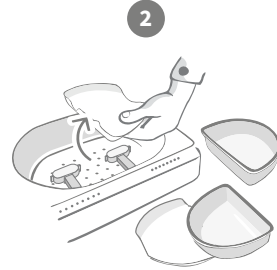

Entfernen Sie die Schalen, deren Halterungen und den Deckel - siehe vorherige Seite.



Bringen Sie alle Teile wieder an und achten Sie dabei darauf, dass Sie **zuerst die Abdeckung des Reinigungszugangs anbringen**.

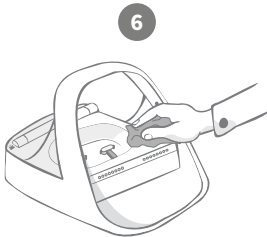

Verwenden Sie ein feuchtes Tuch, um alle Oberflächen des Futtermat sauer zu halten. **Verwenden Sie keine scheuernden Reinigungsmittel**.

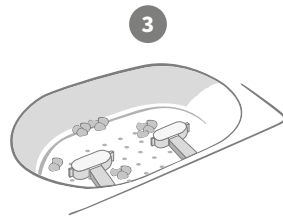

Schmutz an den Wiegearmen kann die Funktionstüchtigkeit des Futtermat beeinträchtigen. Deshalb sollten sie stets sauer bleiben. **Verwenden Sie keine Scheuerschwämme**, da diese den Futtermat beschädigen und deren Funktion beeinträchtigen können.

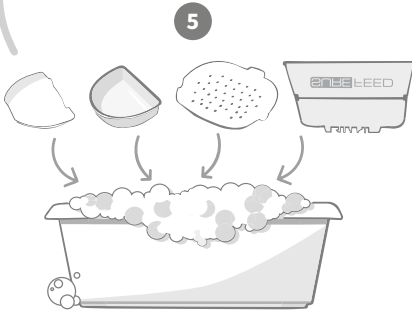

Reinigen Sie alle entfernaren Teile von Hand. Stellen Sie sie nicht in den Geschirrspüler.

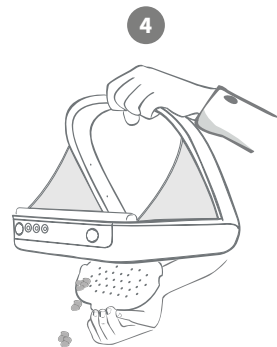

Halten Sie den Futtermat über den Mülleimer, entfernen Sie die Abdeckung des Reinigungszugangs und lassen Sie die Reste herausfallen.



Hilfe und Support

Benutzerdefinierte Einstellungen

Wir wissen, dass sich nicht alle Haustiere gleich verhalten. Daher haben wir den Mikrochip Futterautomat Connect so konstruiert, dass dies berücksichtigt werden kann. Der Automat enthält eine Vielzahl von Einstellungsmöglichkeiten für den Fall, dass Ihre Haustiere ihn in unerwarteter oder ungewöhnlicher Weise verwenden sollten. Nachfolgend einige Verhaltensbeispiele, die sich mit den benutzerdefinierten Einstellungen umgehen lassen:

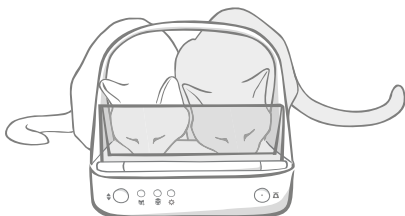

Zwängt sich ein nicht registriertes Haustier an den Automaten, um zusammen mit einem „autorisierten“ Tier zu fressen?

Wir haben dafür eine benutzerdefinierte Einstellung!

Hat das nicht registrierte Haustier die Angewohnheit, sich Zugang zum Futter eines anderen Tieres zu verschaffen, während sich der Automat im Trainingsmodus befindet?

Wir haben dafür eine benutzerdefinierte Einstellung!

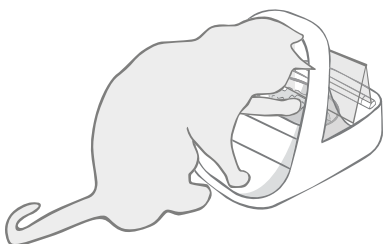
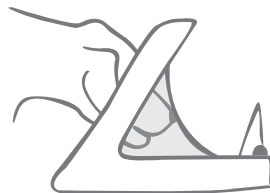

Hat Ihr cleveres, nicht registriertes Haustier herausgefunden, wie man das Schließen des Deckels verhindert?

Wir haben dafür eine benutzerdefinierte Einstellung!

Versucht ein Haustier über die Rückseite des Futterautomaten an Futter zu kommen?

Wir haben Zubehör dafür!

Gehen Sie zu [surepetcare.com/zubehoer](https://www.surepetcare.com/zubehoer) und suchen Sie nach der aufsteckbaren Haube.

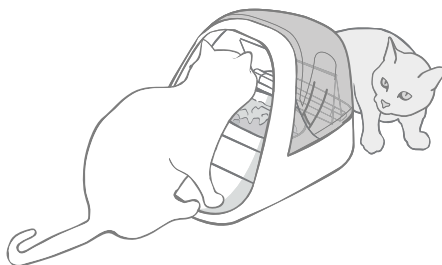

Wenden Sie sich an unseren Kundenservice, um benutzerdefinierte Einstellungen zu erörtern - **die Kontaktinformationen finden Sie auf der hinteren Abdeckung**. Sie können Ihnen die für Ihre Situation optimalen Einstellungen empfehlen und diese auch per Fernzugriff für Sie einrichten.

Der Hub

Rot blinkende Ohren

Die Verbindung zwischen Ihrem Hub und dem Mikrochip Futterautomat Connect ist abgebrochen.

- Sollten **beide Ohren während der Einrichtung rot blinken**, setzen Sie den Hub auf die Werkseinstellungen zurück, indem Sie die Taste an der Basis des Hubs für 10 Sekunden gedrückt halten.
- Wenn **beide Ohren über einen längeren Zeitraum nach der Einrichtung rot blinken**, führen Sie einen Neustart des Hubs durch. Schalten Sie dazu das Gerät für 30 Sekunden aus und anschließend wieder ein. Wenn die Ohren für mehrere Minuten durchgehend grün leuchten, ist der Hub wieder verbunden.
- Sie können auch versuchen, **den Hub** gemäß den Empfehlungen **auf Seite 37. neu aufzustellen**. Sollte sich das Problem jedoch nicht beheben lassen, müssen Sie den Hub näher am Futterautomaten positionieren (siehe unten).
- Um die Entfernung zwischen Ihrem Hub und dem Futterautomaten zu verringern, versuchen Sie ein längeres Ethernet-Kabel an den Router anzuschließen.
- Falls diese Methode nicht funktioniert, raten wir Ihnen zum Kauf eines „**PowerLAN-Adapters**“. Dieser kann direkt an eine Steckdose angeschlossen werden und ermöglicht es Ihnen, den Hub in einer geringeren Entfernung zum Futterautomaten mit dem Internet zu verbinden.

Abwechselnd blinkende Ohren (rot und grün)

Ihr Hub hat Probleme, sich mit den Sure Petcare Servern zu verbinden. Der Grund dafür könnte eine instabile Internetverbindung sein.

- Führen Sie einen Neustart des Hubs durch, indem Sie das Gerät aus- und nach 30 Sekunden wieder einschalten. Wenn die Ohren für mehrere Minuten durchgehend grün leuchten, ist der Hub wieder verbunden.
- Falls die oben aufgeführte Methode nicht zum Erfolg führt, vergewissern Sie sich, dass der Router eingeschaltet ist und Ihre Internetverbindung einwandfrei mit anderen Geräten funktioniert.
- Falls die Verbindung mit anderen Geräten nicht funktioniert, führen Sie einen Neustart des Routers durch, indem Sie ihn ausschalten und nach 30 Sekunden wieder einschalten.
- Falls Ihr Router mit anderen Geräten funktioniert, schließen Sie das Ethernet-Kabel erneut an Router und Hub an. Vergewissern Sie sich, dass das Kabel fest angeschlossen ist. Es hat mitunter den Anschein, dass der Anschluss korrekt erfolgt ist, auch wenn dies gar nicht der Fall ist.

Sollten Sie weiterhin Verbindungsprobleme haben, besuchen Sie: surepetcare.com/hub-connectivity

Durchgehend rot leuchtende Ohren

Die Firmware des Hubs wird gerade aktualisiert. Haben Sie einen Moment Geduld und warten Sie, bis die Ohren des Hubs wieder grün leuchten. Dieser Vorgang sollte nicht länger als 2 Minuten dauern. Nach der Aktualisierung der Firmware muss der Hub neu gestartet werden. Anschließend wird die Einrichtungs-LED-Sequenz angezeigt - **siehe Seite 38**.

Langsame Mitteilungen

Falls einige Mitteilungen in Ihrer App nur sehr langsam angezeigt werden, dann hat der Hub vermutlich Probleme beim Verbindungsaufbau zum Mikrochip Futterautomat Connect. Um die Anzeigegeschwindigkeit zu erhöhen, stellen Sie den Hub an einem geeigneteren Ort auf (**siehe Seite 37**).

Mikrochip Futterautomat Connect

Sollte es zu mechanischen Problemen mit dem Futterautomaten kommen, versuchen Sie bitte nicht, diese selbst zu beheben. Wenden Sie sich stattdessen an unser freundliches Kundenserviceteam - die Kontaktinformationen finden Sie auf der **hinteren Abdeckung**.

Der Futterautomat öffnet sich bei meinem Haustier nicht

- Sorgen Sie dafür, dass die 4 Sensoren an der Öffnung sauber sind - **siehe Seite 49**.
- Vergewissern Sie sich, dass Sie hochwertige Alkali-Batterien verwenden und diese nicht entladen sind. Vergewissern Sie sich, dass die Pole + und - der Batterien korrekt ausgerichtet sind - **siehe Seite 39**.
- Vergrößern Sie die Entfernung des Futterautomaten zu Metall- bzw. Elektrogeräten. Sollte sich der Futterautomat noch immer nicht bei einem erfassten Haustier öffnen, lesen Sie weiter.
- Vergewissern Sie sich, dass sich keine offensichtlichen elektrischen Störquellen in der Nähe befinden (z. B. defekte, flackernde Lampen). Wenn Sie vermuten, dass dies der Fall ist, wenden Sie sich bitte an unseren Kundendienst - **Kontaktinformationen finden Sie auf der hinteren Abdeckung**.
- Falls der obige Vorschlag keine Abhilfe schafft, bitten Sie Ihren Tierarzt, zu überprüfen, ob der Mikrochip des Tieres ordnungsgemäß funktioniert und sich an der richtigen Stelle befindet. Ist er nämlich deutlich verschoben, kann er weniger gut gelesen werden. In der Zwischenzeit können Sie den mitgelieferten Sure Petcare RFID-Halsbandanhänger verwenden. Befestigen Sie den Anhänger am Sicherheits Halsband Ihres Haustieres und wiederholen Sie den Vorgang „Haustier hinzufügen“ - **siehe Seite 43**.

Mein Haustier gewöhnt sich nicht an den Futterautomaten

- Wiederholen Sie die Trainingsschritte und lassen Sie ihm mehr Zeit für die einzelnen Schritte - **siehe Seite 47-48**.
- Halten die Gewöhnungsschwierigkeiten an, führen Sie die Schritte unter **surepetcare.com/cautiouspet** aus. Üben Sie dabei keinen Zwang auf das Tier aus.
- Überprüfen Sie die Umgebung der Futterstelle. Nähert es sich dem Napf immer aus einer bestimmten Richtung? Frisst es nur ungern mit dem Rücken zur Tür? Es gibt keine festgelegte Ausrichtung, nach der der Futterautomat so platziert werden müsste. Wenn möglich, passen Sie ihn also so an, dass sich Ihr Tier dabei möglichst wohlfühlt.
- Wenn die Zeitverzögerung für das Schließen des Deckels (nachdem es gefressen und sich vom Automaten entfernt hat) nicht geeignet erscheint, können Sie die Zeit bis zum Schließen in der Sure Petcare App erhöhen/verkürzen..

Der Deckel des Automaten schließt nicht vollständig

- Dies kann vorkommen, wenn sich unter der Abdeckung oder in der Schließmechanik Futterreste befinden. Um ein vollständiges Schließen zu gewährleisten, entfernen Sie bei jedem Nachfüllen die Futterreste - **siehe Seite 49-50**.
- Versichern Sie sich, dass sich das Gerät nicht im Trainingsmodus befindet. Erfahren Sie mehr zum Verhalten im Trainingsmodus **auf Seite 47**.

Die Portionsanzeige leuchtet, aber die Schale ist leer

Wenn beim Öffnen des Futterautomaten einige der Lichter der Portionsanzeige grün leuchten, obwohl sich kein Futter mehr in den Näpfen befindet, dann ist das Rücksetzen auf Null erforderlich. Um dieses Problem zu beheben, achten Sie darauf, stets die Taste „Null“ zu drücken, bevor Sie das Futter austauschen - **siehe Seite 45-46**.

Die Portionsanzeigen reagieren nicht

- Beachten Sie, dass die Portionsanzeige beim Einfüllen des Futters nicht aufleuchtet, solange Sie kein Portionsgewicht in der Sure Petcare App eingestellt haben.
- Außerdem können Ablagerungen, die sich um die Wiegearme herum festsetzen, die Funktionstüchtigkeit beeinträchtigen. Achten Sie daher darauf, dass dieser Bereich stets sauber ist - **siehe Seite 49-50**.

Andere Tiere fressen das Futter weg

- Versuchen andere Tiere aus dem offenen Futterautomaten zu fressen, dann stellen Sie ihn über die Sure Petcare App so ein, dass sich die Abdeckung nach dem Fressen schneller schließt.
- Möglicherweise gibt es eine benutzerdefinierte Einstellung, die zur Lösung Ihres spezifischen Problems beiträgt. Wenden Sie sich an unser Kundenserviceteam, um Ihr Problem zu erörtern - **die Kontaktinformationen finden Sie auf der hinteren Abdeckung**.
- Für jene Fälle, bei denen besonders gierige Vertreter das Futter entwenden, indem sie um die Rückseite oder die Seite des Futterautomaten herumlaufen (bei geöffneter Klappe, während das berechnigte Tier noch frisst), haben wir eine hintere Abdeckung entwickelt, die dabei hilft, solch cleverem Verhalten Einhalt zu gebieten. Weitere Informationen finden Sie unter **surepetcare.com/zubehoer**

Kurze Batteriebensdauer

- Sorgen Sie dafür, dass der Futterautomat stets sauber ist und kein Schmutz die Sensoren verdeckt - **siehe Seite 49**.
- Vergewissern Sie sich, dass Sie hochwertige Batterien verwenden und diese korrekt eingesetzt wurden - **siehe Seite 39**.
- Vergewissern Sie sich, dass sich keine offensichtlichen elektrischen Störquellen in der Nähe befinden (z. B. defekte, flackernde Lampen). Wenn Sie vermuten, dass dies der Fall ist, wenden Sie sich bitte an den Kundendienst. Die Kontaktinformationen finden Sie auf der **hinteren Abdeckung**

Mehrere Futterautomaten in einem Haushalt

- Sollten Sie feststellen, dass Sie oder auch Ihre Tiere Schwierigkeiten beim Unterscheiden der einzelnen Automaten haben, dann versuchen Sie es mit verschiedenfarbigen Accessoires und mit verschiedenen Futterplätzen. Das sollte Abhilfe schaffen. Verschiedenfarbige Schalen und Matten werden separat angeboten. Weitere Informationen finden Sie unter **surepetcare.com/zubehoer**

Sie benötigen immer noch Hilfe?

- Sollten Sie weiterhin Verbindungsprobleme haben, besuchen Sie: **surepetcare.com/hub-connectivity**
- Eine noch ausführlichere Anleitung, Videos und Kundenhilfeforen finden Sie unter: **surepetcare.com/kundenservice**
- Falls Sie Probleme mit Ihrer Sure Petcare App haben, besuchen Sie bitte die folgende Seite: **surepetcare.com/apphelp**



Oder wenden Sie sich an unseren Kundendienst, der Ihnen gern behilflich sein wird.

Die Kontaktinformationen finden Sie auf der hinteren Abdeckung.



Garantie und Haftungsausschluss

Garantie: Für den SureFeed Mikrochip Futterautomat Connect gilt eine Garantie von 3 Jahren ab Kaufdatum, das mit Kaufbeleg nachzuweisen ist. Die Garantie ist auf Mängel, die durch fehlerhafte Materialien, Komponenten oder Herstellung zurückzuführen sind, beschränkt. Diese Garantie gilt nicht für Mängel, die durch normale Abnutzung, unsachgemäße Verwendung oder vorsätzliche Beschädigung entstanden sind. Im Falle eines teilweisen Versagens aufgrund fehlerhafter Teile oder mangelhafter Verarbeitung werden die betroffenen Teile während der Garantiezeit kostenfrei ersetzt. Bei erheblicher Fehlfunktion liegt es im Ermessen des Herstellers, kostenlos ein Ersatzprodukt zur Verfügung zu stellen. Ihre gesetzlichen Rechte werden dadurch nicht berührt.

Haftungsausschluss: Der Mikrochip Futterautomat Connect und die App melden den Futtermittelverbrauch, indem sie die Mikrochip-ID eines Haustieres erkennen und anschließend das Gewicht des Napfes vor und nach der Fütterung messen. In den meisten Fällen liefert dies zuverlässige Daten über gefressene Futtermenge, allerdings kann eine zweckfremde Verwendung des Automaten (wenn der Napf beispielsweise bewegt wird oder das Tier mit dem Futter spielt) zu unzuverlässigen Angaben führen. Sure Petcare kann keine Haftung für Schäden, Verletzungen oder Unannehmlichkeiten übernehmen, die aus einer inkorrekten Erfassung des Futtermittelverbrauchs resultieren können.

Der SureFeed Mikrochip Futterautomat Connect wurde mit speziell entwickelten Funktionen ausgestattet, die weitestgehend verhindern, dass sich andere Haustiere Zugang zum Futter verschaffen. Es ist jedoch nicht möglich, hundertprozentig zu verhindern, dass andere Tiere sich Zugriff auf das Futter verschaffen. In dem seltenen Fall, dass ein nicht registriertes Haustier Zugang zum Futterautomaten erhält, kann Sure Petcare keine Haftung für eventuelle Schäden oder Unannehmlichkeiten übernehmen.



Entsorgung von Produkten und gebrauchten Batterien: Dieses Symbol zeigt an, dass Produkte den folgenden gesetzlichen Vorschriften unterliegen:

Durch die Richtlinie 2012/19/EU über Elektro- und Elektronik-Altgeräte (WEEE-Richtlinie) und die Batterierichtlinie 2006/66/EG einschließlich der Änderung 2013/56/EU werden Haushalte verpflichtet, Altbatterien und Produkte, die das Ende ihrer Lebensdauer erreicht haben, umweltgerecht zu entsorgen und dadurch die Umweltauswirkungen solcher Abfälle zu verringern. Deshalb dürfen diese Abfälle nicht in den Hausmüll entsorgt werden und sind in einer entsprechenden Einrichtung dem Recycling zuzuführen.

Ersetzen Sie Batterien vor dem auf der Batteriepackung angegebenen Ablaufdatum und entsorgen Sie sie auf sichere und angemessene Weise.

Tragen Sie im Falle austretender Batteriesäure zum Schutz vor schädlichen Chemikalien unbedingt geeignete Schutzkleidung und reinigen Sie die Batterien von Säure, bevor Sie sie entsorgen. Batteriesäure darf nicht auf die Haut gelangen. Der Augenkontakt mit bzw. das Verschlucken von Batteriechemikalien ist unbedingt zu vermeiden. Falls es jedoch dazu kommt, wenden Sie sich umgehend an einen Arzt.

Marken: Google Play und das Google Play Logo sind Marken von Google Inc.

Apple ist eine in den USA und anderen Ländern eingetragene Marke von Apple Inc. App Store ist eine in den USA und anderen Ländern eingetragene Marke von Apple Inc. IOS ist eine in den USA und anderen Ländern eingetragene Marke von Cisco und wird unter Lizenz verwendet.



SURE[™]
PETCARE

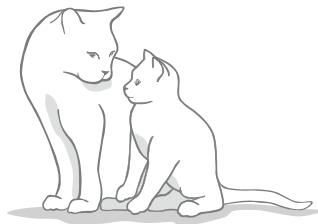

Prise en main de votre nouveau Distributeur de Nourriture Connect

Merci d'avoir choisi le distributeur de nourriture Connect !

Le système du distributeur de nourriture Connect est composé de trois éléments travaillant ensemble pour vous permettre de rester connecté avec votre animal et de mieux comprendre ses habitudes alimentaires.

Le **distributeur de nourriture Connect** est le composant principal du système. Il reconnaît la puce de votre animal ou son médaillon d'identification par radiofréquence Sure Petcare (une unité incluse), permettant ainsi à votre animal d'avoir accès à sa nourriture, tout en empêchant d'autres animaux d'y accéder.

Le **hub** (vendu séparément) est l'élément connecté du système. Il se connecte à votre réseau Internet et peut communiquer avec le distributeur de nourriture et votre application Sure Petcare.

En utilisant l'**application Sure Petcare**, vous pourrez contrôler la quantité de nourriture que votre animal a mangé et à quelle fréquence il visite le distributeur de nourriture. L'application vous permet également de définir une quantité afin de contrôler les portions de nourriture.

Contenu du coffret

Vérifiez que vous disposez bien de tous les composants suivants*

- 1 1x distributeur de nourriture Connect
- 2 1x bol simple
- 3 2x demi-bols
- 4 1x tapis
- 5 1x support pour bol simple
- 6 2x supports pour demi-bols
- 7 1x médaillon d'identification par radiofréquence Sure Petcare

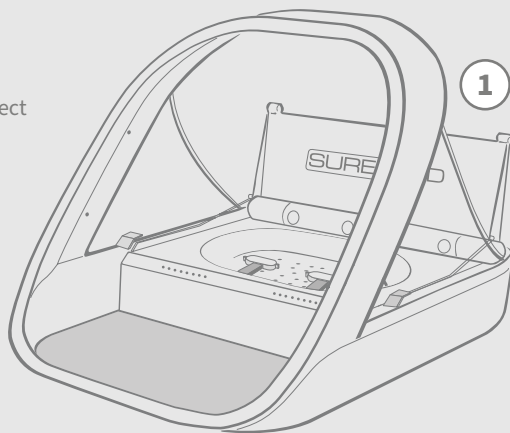

*Les piles et le hub ne sont pas inclus.

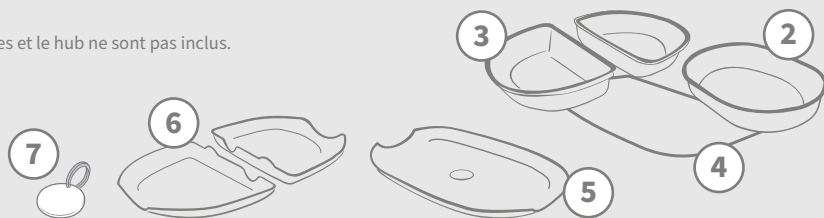

Vous devez aussi vous munir d'un hub afin que votre distributeur de nourriture Connect fonctionne en tant que système connecté. Pour plus d'informations sur l'achat du hub, rendez-vous sur surepetcare.com/hub

Sommaire

Informations importantes.....	59
Présentation du produit.....	61
Fonctionnement du distributeur de nourriture Connect	63
Hub	
Configuration de votre hub.....	64
Où placer votre hub	65
Témoins lumineux du hub	66
Distributeur de nourriture	
Piles	67
Connectez votre distributeur de nourriture.....	68
Boutons et témoins lumineux	69
Enregistrement de la puce d'un animal au distributeur de nourriture	71
Réglage des portions	72
Ajout et remplacement de la nourriture	73
Mode d'apprentissage.....	75
Nettoyage et entretien	77
Aide et support	79
Garantie et clause de non-responsabilité	83

i

Informations importantes



LISEZ LES INFORMATIONS SUIVANTES AVEC ATTENTION ET CONSERVEZ CE GUIDE POUR RÉFÉRENCE ULTÉRIEURE.



Ce produit est destiné aux **animaux domestiques uniquement**.



Utilisez uniquement des accessoires SureFeed pour vous assurer de la compatibilité : surepetcare.com/accessoires



Vérifiez que vous possédez tous les composants répertoriés **page 57**.



Ne placez pas le distributeur dans des zones de passage.



Le distributeur est conçu pour une utilisation **en intérieur uniquement**.



Ne pas immerger le distributeur de nourriture dans l'eau et ne pas placer sous l'eau du robinet.



Ne pas placer le distributeur de nourriture dans le réfrigérateur et ne pas mettre de glace en dessous ou à l'intérieur de celui-ci.



Ne pas placer le distributeur de nourriture dans un endroit où il peut être exposé à une chaleur excessive.



Ce produit requiert **quatre piles R14** qui doivent être insérées et remplacées avec précaution. Ne mélangez pas différents types de piles ou des piles neuves et usagées. Si vous prévoyez de ne pas utiliser le distributeur de nourriture pendant une longue période, veuillez retirer les piles.

Vous trouverez le **code produit** et le **numéro de série** du distributeur de nourriture Connect sous le produit.

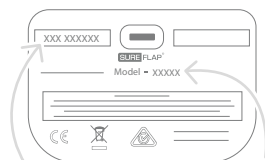

Numéro de série Code produit

Avertissements de sécurité

- **N'utilisez pas** ce produit si l'un des composants est usé, endommagé ou manquant.
- **De petits composants ont été utilisés dans la fabrication de cet article.** Tous les éléments lâches doivent être tenus hors de portée des jeunes enfants et des animaux afin **d'éviter tout risque d'étouffement**.

Autres facteurs à prendre en compte



ANIMAUX : Sure Petcare vous conseille d'utiliser le distributeur de nourriture Connect SureFeed avec la puce de votre animal. Il peut toutefois être utilisé avec le médaillon d'identification par radiofréquence Sure Petcare. Si vous utilisez un médaillon, veillez à utiliser un collier de sécurité **doté d'une boucle de sécurité** (chats uniquement). Sure Petcare ne saurait être tenu responsable de tout accident mortel ou blessure causé par le médaillon de votre animal.



ACCÈS À LA NOURRITURE : Sure Petcare ne peut être tenu responsable de tout accès à la nourriture par un animal non autorisé en raison d'une utilisation non conforme. En tant que propriétaire de ce produit, **vous acceptez l'entière responsabilité de superviser l'administration de toute nourriture** qui pourrait causer des dommages à d'autres animaux domestiques si celle-ci est consommée par inadvertance.



AUCUNE FONCTION MINUTERIE : ce produit ne contient pas de minuterie et **ne dispose d'aucune fonctionnalité liée au temps**. Par conséquent, ne laissez pas votre animal sans surveillance ou ne comptez pas sur ce produit pour l'alimenter pendant des périodes prolongées ; pas plus de 24 heures pour un chat ou le temps moyen entre les repas pour un petit chien. **Ce produit ne remplace en aucun cas un comportement responsable.**



ENFANTS : les enfants **ne doivent pas être autorisés à jouer avec le distributeur de nourriture Connect SureFeed**. Ce dispositif n'est pas un jouet et ne doit pas être manipulé en tant que tel. Il peut toutefois être utilisé par les enfants de plus de 8 ans et les personnes présentant des capacités physiques, sensorielles ou mentales réduites, dans la mesure où ils sont sous surveillance ou ont reçu des instructions sur l'utilisation sûre du produit. Ils doivent toujours être informés des risques potentiels. Ne laissez pas des enfants nettoyer le produit sans surveillance.



SÉCURITÉ ENFANTS : si vous avez des enfants, il est essentiel de **prendre en compte cet aspect lors de l'utilisation du distributeur de nourriture Connect SureFeed**. La mauvaise utilisation de ce produit par un enfant risque d'exposer ce dernier à des dangers potentiels. C'est pourquoi il est nécessaire de surveiller en permanence les jeunes enfants lorsqu'ils se trouvent à proximité du distributeur de nourriture. Sachez aussi que lorsque le distributeur de nourriture est en mode **apprentissage (voir la page 75-76)**, **un enfant sera tout de même en mesure d'accéder à la nourriture de l'animal.**



Présentation du produit

Le système du distributeur de nourriture Connect présente trois composants principaux :



Distributeur de nourriture
Connect



Hub



Distributeur de nourriture
Connect

Le hub est connecté à Internet à l'aide d'un câble Ethernet et assure la connexion avec votre distributeur de nourriture Connect. Il communique à la fois avec le distributeur de nourriture et avec l'application Sure Petcare, vous permettant ainsi d'avoir les nouvelles données dans l'application même lorsque vous n'êtes pas à la maison.

Vous pouvez également définir une quantité de nourriture dans l'application. Une fois configuré, le distributeur vous guidera lorsque vous y ajouterez de la nourriture afin de vous assurer de donner la bonne quantité. Pour plus d'informations, **consultez la page 70.**

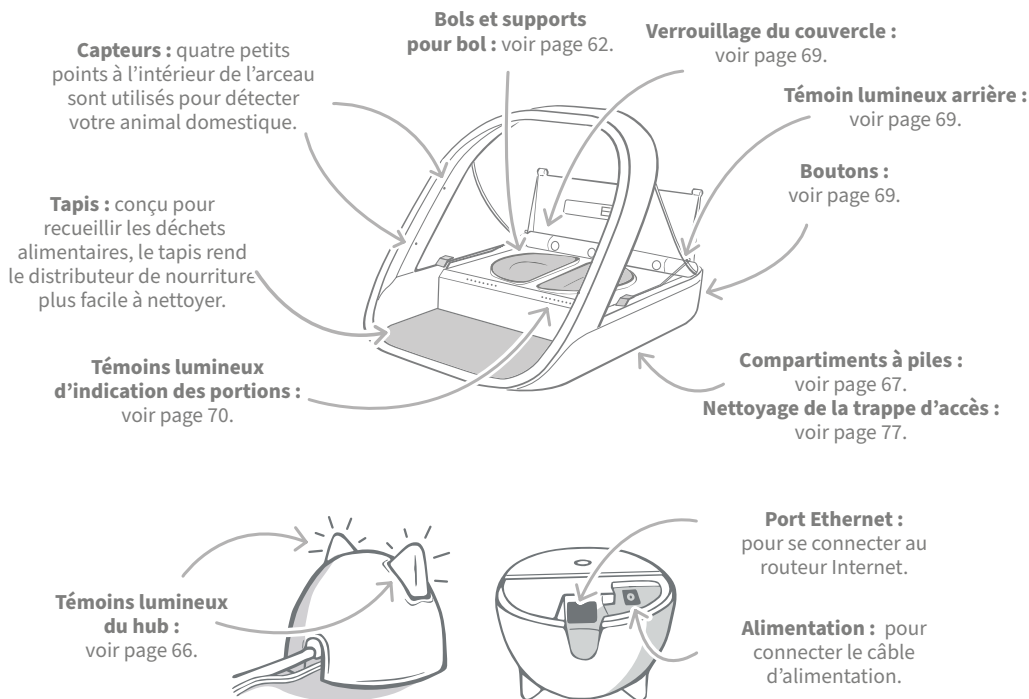

Les bols SureFeed possèdent un joint sur le bord supérieur ce qui permet d'assurer la fraîcheur de la nourriture plus longtemps. Si vous ne donnez qu'un seul type de nourriture à votre animal, vous pouvez utiliser le bol simple, mais si vous lui donnez de la nourriture humide et sèche, alors les demi-bols seront parfaits.



Bol simple : peut contenir jusqu'à 250 g, suffisant pour au moins 2 sachets d'aliments humides.



Demi-bols : chaque bol peut contenir jusqu'à 100 g ou 200 g répartis sur les deux bols.

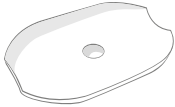

Support de bol simple : est conçu pour supporter le bol simple (pas les demi-bols).



Supports de demi-bol : chaque support est conçu pour supporter un demi-bol (pas le bol simple).

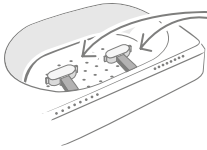

Bras de pesée : conçus pour maintenir les supports de bol.

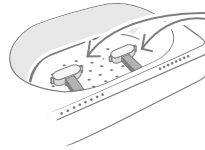

Bras de pesée : conçus pour maintenir les supports de bol.



Ne versez pas la nourriture directement sur les supports de bols. Veuillez à toujours utiliser les bols pour assurer le bon fonctionnement du distributeur de nourriture.

Le bol double SureFeed n'est pas conçu pour être utilisé avec le distributeur de nourriture Connect.

Pour acheter des bols ou des tapis supplémentaires, veuillez contacter un revendeur Sure Petcare ou rendez vous sur le site surepetcare.com

Ajoutez de la couleur

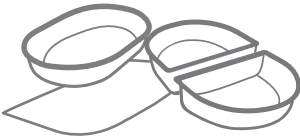

Les tapis et bols en plastique SureFeed sont disponibles en quatre couleurs différentes : bleu, vert, rose et gris.

Ou ajoutez un peu de brillant

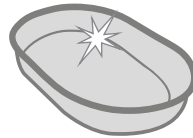

Le bol simple SureFeed est également disponible en acier inoxydable.



Ne pas mettre les bols au lave-vaisselle ou au micro-ondes.



Nettoyez les bols avant la première utilisation



Fonctionnement du distributeur de nourriture Connect

Téléchargez l'application gratuite Sure Petcare dès maintenant

TÉLÉCHARGER DANS
APP STORE

DISPONIBLE SUR
GOOGLE PLAY



surepetcare.io



Recevez des notifications lorsque votre animal mange dans le distributeur de nourriture.



Surveillez la ration alimentaire de votre animal et remarquez des changements de comportement.



Ajustez les portions avec précision pour contrôler la quantité consommée.



Partagez l'accès à votre foyer avec votre famille et vos amis.



Téléchargez l'**application Sure Petcare** et créez un compte. Vous serez ensuite invité à créer un « foyer » (un réseau connecté qui comprendra tous vos animaux domestiques et tous vos produits connectés Sure Petcare). Vous pouvez même inviter d'autres membres de votre famille à rejoindre votre foyer.

Pour télécharger l'application, votre téléphone ou tablette doit disposer de la version **iOS 9** pour **Apple** (ou version ultérieure) ou **4.4** pour **Android** (ou version ultérieure).



Si vous préférez contrôler les différents produits connectés Sure Petcare depuis votre ordinateur, vous pouvez utiliser l'application Web Sure Petcare à l'adresse suivante : **surepetcare.io**

Vous aurez besoin de la dernière version de **Safari, Chrome, Firefox ou Internet Explorer sur Mac OS X v10.9** (ou version ultérieure) ou **Windows 7** (ou version ultérieure).

Acheter un hub Sure Petcare



Pour que votre distributeur de nourriture Connect fonctionne avec l'application Sure Petcare, vous devez acheter un hub associé. Pour plus d'informations, rendez-vous sur **surepetcare.com/hub**



Configuration de votre hub

Une fois que vous avez téléchargé l'application Sure Petcare, vous devez brancher votre hub et le configurer. Une fois votre hub configuré, vous devez le connecter au distributeur de nourriture et à l'application. Suivez les étapes ci-dessous :

1

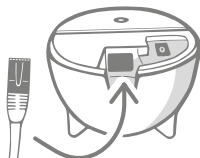

Branchez une extrémité du câble Ethernet sur la base de votre hub et l'autre sur un port Ethernet de votre routeur.

2

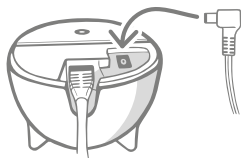

Montez l'alimentation et branchez-la sur la prise secteur. Branchez l'autre extrémité du câble sur la base de votre hub.

3

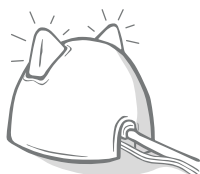

Les "oreilles" de votre hub commencent alors à **clignoter rouge et vert**. Lorsqu'elles arrêtent de clignoter et s'illuminent en vert, votre hub est prêt. Si elles ne clignent pas, **consultez la page 66** pour plus d'informations

4



Pour terminer la configuration de votre distributeur de nourriture Connect, vous devez **suivre les étapes restantes sur l'application Sure Petcare**.



Votre hub peut faire l'objet d'une mise à jour de logiciel. Si les témoins affichent **une lumière rouge continue** pendant la configuration, ne vous inquiétez pas, cela signifie que votre hub est en cours de mise à jour de logiciel. Une fois celle-ci terminée, le hub redémarrera et la séquence lumineuse décrite à l'étape 3 se produira.



Où placer votre hub

Votre distributeur de nourriture Connect communique grâce à la technologie sans fil. L'emplacement de votre hub joue donc un rôle important dans ses performances.



Placez le hub à au moins 1 mètre du sol (par exemple, sur une table ou une étagère dépourvue d'obstructions).

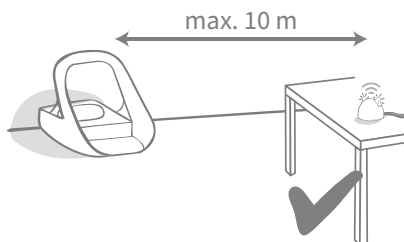

Essayez de placer votre hub de façon à ce qu'il soit dans la ligne de mire de votre distributeur de nourriture et à moins de 10 mètres de distance.

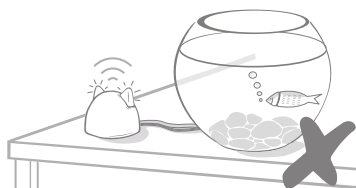

Évitez de placer votre hub à proximité de grandes quantités d'eau comme des aquariums.

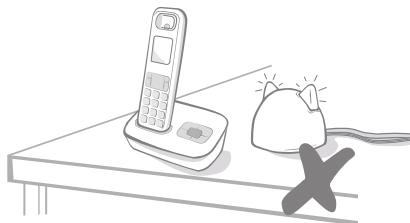

Tenez votre hub aussi loin que possible de toute source potentielle d'interférence (par exemple, téléphones sans fil, babyphones, etc.).



Veillez à ce que le hub ne soit pas placé près de grands objets métalliques tels que des réfrigérateurs.

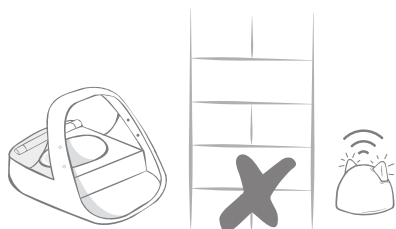

Il est préférable de ne pas avoir de mur épais entre le hub et le distributeur de nourriture.



Il se peut que votre hub rencontre parfois des problèmes de connexion malgré les astuces précitées. Pour plus d'informations sur le placement de votre hub à proximité de votre distributeur de nourriture Connect, rendez-vous sur [surepetcare.com/hub-connectivity](https://www.surepetcare.com/hub-connectivity)



Si votre hub perd la connexion Internet pour quelque raison que ce soit, votre distributeur de nourriture Connect continuera à fonctionner normalement en conservant ses paramètres.



Témoins lumineux du hub

Le statut de votre hub est indiqué par les témoins lumineux latéraux. Les couleurs des différentes séquences lumineuses ont différentes significations.

Témoins de configuration

À chaque fois que le hub s'allume ou essaye d'établir une connexion avec d'autres éléments du système, les témoins s'allument :

1 Les oreilles affichent temporairement une **couleur rouge alternant**,



2 puis une **couleur verte alternant**,



3 une fois que les oreilles **clignotent en orange** puis affichent une **couleur verte continue**, le hub est connecté.



Témoins latéraux verts

Lorsque les oreilles sont vertes, cela signifie que le hub fonctionne correctement. Les significations des différentes séquences lumineuses sont indiquées ci-dessous.

Les deux oreilles affichent une couleur verte continue : votre hub est allumé, connecté et fonctionne normalement.

Témoins verts alternant : votre hub est en train de se reconnecter à nos serveurs.

Témoins latéraux rouges

Les deux oreilles affichent une couleur rouge continue : votre hub est en cours de mise à jour. Soyez patient, votre hub redémarrera et fonctionnera normalement dans peu de temps.

Les deux oreilles clignotent en rouge : votre hub a perdu la connexion avec votre distributeur de nourriture et tente de se reconnecter.

Témoins rouges alternant : votre hub connaît des difficultés à se connecter à Internet et/ou à nos serveurs.

i Pour en savoir plus sur comment diagnostiquer ces problèmes, veuillez consulter la page 80.



Piles

Utilisez toujours **quatre piles alcalines R14 1,5 V de bonne qualité**. Vous profiterez ainsi des meilleures performances de votre distributeur de nourriture Connect. **Ce produit N'EST PAS conçu pour être utilisé avec des piles rechargeables.**

Pour insérer ou changer les piles, suivez les étapes ci-dessous :

i Vous trouverez un témoin près de l'arrière du distributeur de nourriture. Si le niveau des piles est bas ou s'il y a un problème avec la façon dont elles ont été insérées, ce témoin clignotera en rouge toutes les 5 secondes.

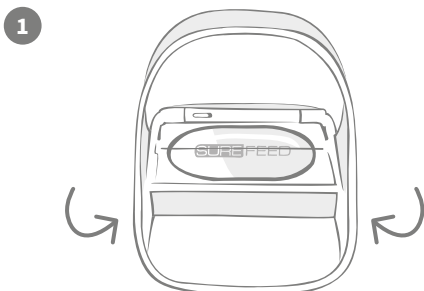

Retournez le distributeur de nourriture pour accéder aux compartiments des piles.

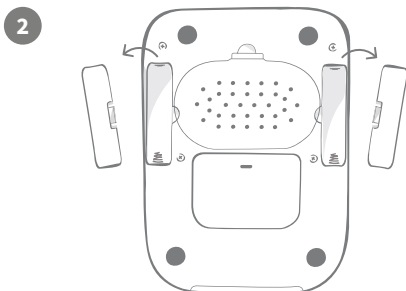

Retirez les couvercles des compartiments des piles.

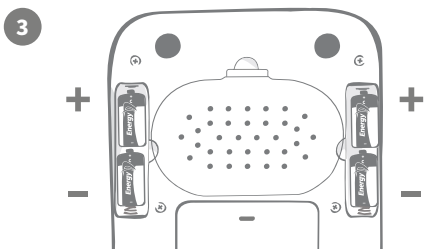

Insérez les piles. Assurez-vous que les symboles +/- sur les piles correspondent aux symboles sur le distributeur de nourriture.

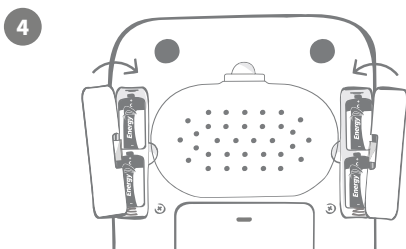

Remettez les couvercles des compartiments des piles en place.



Une fois que vous avez programmé l'identifiant de la puce de votre animal dans le distributeur de nourriture, celui-ci sera enregistré en permanence dans sa mémoire. Cela signifie que même lorsque vous changez les piles, le distributeur de nourriture reconnaîtra votre animal domestique autorisé.



Connectez votre distributeur de nourriture

Pour terminer la configuration de votre système connecté, vous devrez connecter le distributeur de nourriture à votre foyer.

1

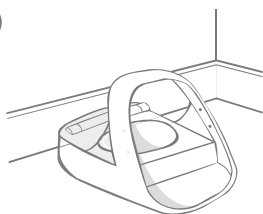

Placez votre distributeur de nourriture dans l'espace prévu et assurez-vous de la communication avec le Hub.

2



Dans l'application Sure Petcare, sélectionnez « **Ajouter produit** ».

3



Cela mettra votre hub en mode de connexion et les oreilles clignoteront en vert.

4

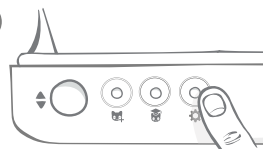

Appuyez une fois sur le bouton Paramètres « **⚙** » sur le distributeur de nourriture. Le témoin lumineux s'allume en vert.

5

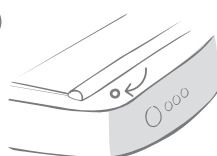

Une fois que le distributeur de nourriture est connecté, le témoin lumineux s'éteint et le hub cesse de clignoter.

i

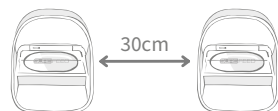

Si vous souhaitez connecter davantage de distributeurs de nourriture, vous pouvez le faire facilement à partir de l'application.

Ajout d'un distributeur de nourriture à votre foyer actuel



Vous pouvez ajouter un distributeur de nourriture Connect à votre foyer Sure Petcare existant via l'application. Accédez à la section Foyer et suivez les instructions ci-dessus.

Vous pouvez également attribuer l'identifiant de la puce de votre animal à distance via l'application. Ainsi, vous n'aurez pas à l'ajouter manuellement. Cependant, l'ajout de friandises peut encourager vos animaux domestiques à utiliser le nouveau produit. Pour en savoir plus sur comment ajouter des animaux, **veuillez consulter la page 71.**



Boutons et témoins lumineux

Boutons

Il y a 5 boutons sur le distributeur de nourriture. Ceux-ci sont situés à l'arrière du produit :

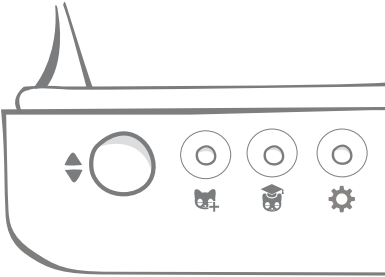

Bouton « Ouverture/fermeture » : ouvre et ferme le couvercle pour vous permettre d'accéder au(x) bol(s).



Bouton « Ajouter un animal » B permet d'ajouter l'identifiant de la puce électronique de votre animal dans la mémoire du distributeur de nourriture, **voir page 71.**



Bouton « Mode Apprentissage » : permet d'activer le mode d'apprentissage pour éduquer votre animal à l'utilisation du distributeur de nourriture, **voir page 75-76.**



Bouton « Paramètres » : utilisé pour connecter le distributeur de nourriture et le hub, **voir page 68.**



Bouton « Remise à zéro » : utilisé pour calibrer le distributeur de nourriture et pour vous assurer de donner la bonne quantité de nourriture, **voir page 73.** Ce bouton réinitialisera **les deux côtés du distributeur de nourriture, que vous utilisez un bol simple ou les demi-bols.**



Lorsque vous utilisez les demi-bols, si vous souhaitez les réinitialiser indépendamment, vous pouvez le faire en utilisant **l'application Sure Petcare.**

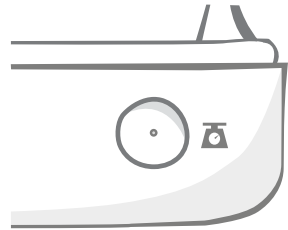

Verrouillage du couvercle



Verrouillé : signifie que vous ne pouvez pas tirer et retirer le couvercle du distributeur de nourriture.



Déverrouillé : signifie que vous pouvez tirer sur le couvercle lorsqu'il est en position ouvert pour le retirer.

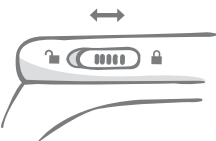
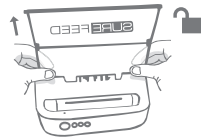

Le couvercle doit **rester en position verrouillé** à tout moment et ne peut être déverrouillé que lorsque vous souhaitez retirer le couvercle pour le nettoyer. Vous pouvez ainsi empêcher les animaux les plus habiles et non autorisés d'essayer de retirer le couvercle pour accéder à la nourriture. **Sachez que cela n'empêche pas le couvercle de s'ouvrir.**

Témoin lumineux arrière

Couleur verte continue. Le témoin vert s'allume chaque fois qu'un animal autorisé mange dans le distributeur de nourriture.

Couleur verte clignotante. Le distributeur de nourriture est en mode « Ajouter un animal », voir page 71. Le témoin continuera à clignoter jusqu'à ce qu'une puce soit ajoutée ou jusqu'à ce que vous quittiez le mode.

Couleur orange clignotante. Le distributeur de nourriture est en mode d'apprentissage, voir page 75-76. Le nombre de clignotements se rapporte à l'étape de l'apprentissage.

Couleur rouge clignotante. Les piles sont presque déchargées.

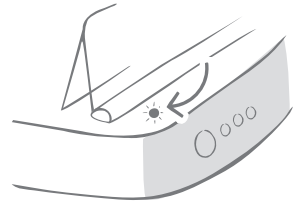

Témoins lumineux d'indication des portions

Si vous avez défini un poids de portion dans l'application Sure Petcare, les témoins situés à l'avant du distributeur de nourriture servent de guide lors de l'ajout de nourriture.

Les témoins d'indication de portion représentent la quantité de nourriture que vous avez ajoutée afin que vous puissiez vous assurer que votre animal reçoive la bonne portion.

Pour plus d'informations sur les avantages concernant la régulation du poids de portion, veuillez vous rendre à la page 72.

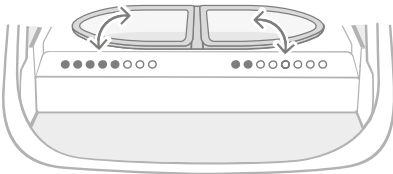
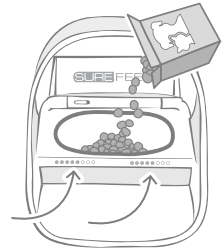

Utilisation des demi-bols

Les témoins lumineux situés à droite du distributeur de nourriture correspondent au bol situé à droite et il en va de même pour le côté gauche. Le témoin s'allume lorsque vous ajoutez de la nourriture des deux côtés.

Utilisation du bol simple

Les deux jeux de témoins lumineux s'allumeront simultanément lorsque vous ajoutez de la nourriture au bol simple.

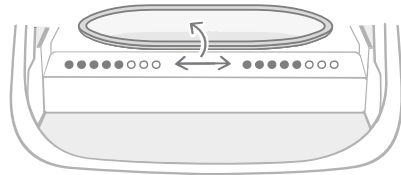

Si vous souhaitez passer des demi-bols à un bol simple et inversement, vous devez effectuer le changement via l'application Sure Petcare.



Si vous n'avez pas défini de poids de portion dans l'application, les témoins lumineux ne s'allumeront pas lorsque des aliments seront ajoutés au distributeur de nourriture.



Enregistrement de la puce d'un animal au distributeur de nourriture

Lors de l'ajout de l'identifiant de la puce électronique de votre animal au distributeur de nourriture Connect, assurez-vous que tous les autres animaux de compagnie et les médaillons soient tenus à l'écart.

1

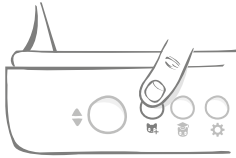

Appuyez sur le bouton « Ajouter un animal » (🐱) à l'arrière du distributeur de nourriture.

2

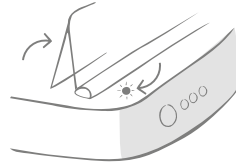

Le couvercle s'ouvre et les témoins lumineux arrière clignotent en vert une fois toutes les secondes.

3

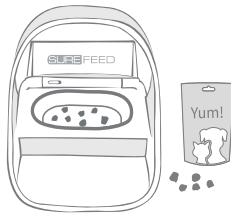

Placez un peu de nourriture ou de friandises dans le bol et placez le distributeur de nourriture à l'emplacement où vous avez l'habitude de nourrir votre animal domestique.

4



Pendant que votre animal mange, le distributeur de nourriture vérifie l'identifiant de sa puce électronique. Une fois l'identifiant ajouté, **les témoins lumineux cessent de clignoter** (mais restent allumés).

5

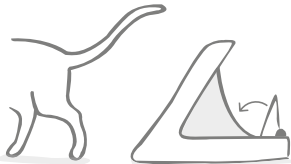

Lorsque votre animal s'éloigne, le couvercle se ferme et le témoin vert s'éteint. L'identifiant de la puce électronique est maintenant enregistré de manière permanente.

i



Si besoin, vous pouvez annuler le mode « Ajouter un animal » à tout moment en appuyant une deuxième fois sur le bouton « Ajouter un animal » (🐱).



Pour programmer l'identifiant de la puce électronique d'un animal de compagnie, les capteurs situés dans l'arceau du distributeur de nourriture doivent détecter la présence de l'animal. Il est donc important que votre animal passe la tête dans l'arceau pour manger.



Pour procéder à l'ajout d'un médaillon d'identification par radiofréquence Sure Petcare, suivez les étapes ci-dessus mais tenez le médaillon à l'intérieur de l'arceau. Assurez-vous de ne porter aucun bijou métallique lorsque vous enregistrez un médaillon.



Si vous avez déjà un animal de compagnie dans votre foyer Sure Petcare, il est possible de l'affecter au distributeur de nourriture. Accédez à la section « Foyer » dans l'application. Si vous ajoutez un animal par erreur, vous pourrez toujours le modifier dans l'appli.



Réglage des portions

Le distributeur de nourriture Connect contrôle non seulement ce que votre animal a mangé mais aussi quand il a mangé. Il peut aussi vous aider à donner des portions précises à chaque fois que vous nourrissez votre animal.

Pourquoi contrôler les portions que vous donnez à votre animal ?

Votre animal a-t-il besoin de perdre du poids ? En définissant un poids de portion, vous vous assurez de ne pas leur donner accidentellement trop de nourriture tous les jours. Tout s'additionne !

La capacité de peser des portions de nourriture directement dans le distributeur de nourriture facilite et accélère la tâche, et permet de s'assurer que votre animal mange la bonne quantité.

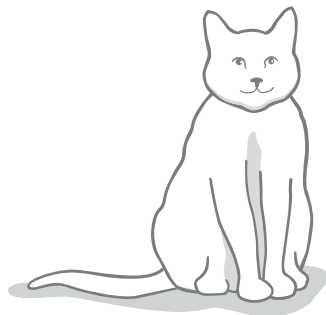

Quelle quantité de nourriture devriez-vous donner à votre animal de compagnie ?

Il peut s'avérer difficile de savoir quelle quantité est la bonne pour votre animal, surtout lorsqu'il y a autant de choix de marques de nourriture. Nous vous recommandons de consulter votre vétérinaire ou votre conseiller en santé animale pour connaître ses recommandations.

Sinon, respectez les consignes fournies sur l'emballage par le fabricant. Les informations sur les emballages sont généralement de bon conseil pour les animaux domestiques en bonne santé.

Comment définir un poids de portion dans l'application ?

Vous pouvez définir un poids de portion dans l'application Sure Petcare. Une fois défini, cette information est envoyée au distributeur de nourriture afin qu'il sache la quantité de nourriture que vous souhaitez donner à votre animal de compagnie à chaque portion.

Les témoins lumineux d'indication de quantité sur le distributeur de nourriture vous guideront au fur et à mesure que la nourriture est ajoutée pour vous assurer que votre animal mange la portion correcte. Les témoins lumineux représentent la quantité de nourriture ajoutée, **voir page 74** pour plus d'informations.





Ajout et remplacement de la nourriture

Il est important de changer quotidiennement la nourriture de votre animal, non seulement pour vous assurer que votre compagnon soit heureux et en bonne santé, mais aussi pour garder le distributeur de nourriture propre et en bon état de marche.

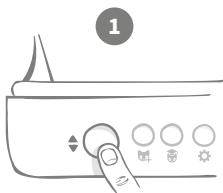

1
Appuyez sur le bouton d'ouverture/fermeture (↕).



2
Retirez le ou les bols sales et les déchets alimentaires. Nettoyez-les ou remplacez-les par des bols propres.



3
Lorsque les bols contiennent la portion complète, les témoins lumineux clignotent en vert.



4
Après la séquence de remise à zéro, commencez à remplir les bols. Les témoins lumineux d'indication de portion s'allument pour indiquer la quantité de nourriture dans chaque bol, voir page suivante.

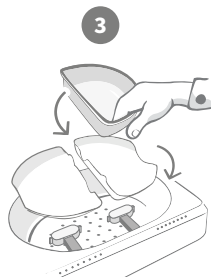

5
Assurez-vous que les supports appropriés pour les bols simples ou les demi-bols soient correctement posés sur les bras de pesée et **placez un bol vide sur le dessus**.



6
Appuyez sur le bouton de « remise à zéro », avant de remplir les bols, afin de vous assurer de donner une portion entière à votre animal domestique. Ce bouton de remise à zéro réinitialisera les deux côtés du distributeur de nourriture, voir page 69.

Témoins lumineux d'indication de portion



Séquence des témoins de remise à zéro :

Des témoins lumineux verts s'allument de droite à gauche lorsque vous appuyez sur le bouton de « remise à zéro ».



Ajout de nourriture :

Au fur et à mesure que les aliments sont ajoutés, les témoins lumineux d'indication de portion s'allument en vert de gauche à droite. Les témoins lumineux correspondent à la quantité de nourriture dans le bol. Vous devez continuer à ajouter de la nourriture jusqu'à ce que tous les témoins lumineux clignotent.



Atteindre le poids défini de la portion :

Lorsque vous êtes à +/- 1 g du poids de la portion, les témoins lumineux **clignoteront en vert**. Si les témoins lumineux ne clignotent pas, cela signifie que vous n'avez pas encore atteint la portion complète.



Débordement :

Si vous ajoutez plus de nourriture que nécessaire dans le bol, les **témoins lumineux rouges** vous avertiront de la quantité dépassée. Retirez simplement un peu de nourriture jusqu'à ce que les témoins lumineux verts clignotent.



Veillez noter que si vous n'avez pas défini de poids de portion dans l'application, les témoins lumineux **ne s'allument pas** lorsque des aliments sont ajoutés au distributeur de nourriture.

Reste-t-il de la nourriture dans le bol ?

S'il reste encore des aliments dans le bol au moment du repas, inutile d'appuyer sur le bouton de remise zéro, ajoutez simplement plus de nourriture dans le distributeur et celui-ci vous permettra d'ajouter une nouvelle portion en plus de la nourriture restante. Le voyant de portion permet d'ajouter une portion complète et de l'indiquer en tant que telle.

1

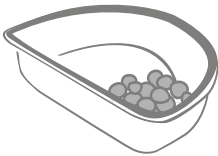

Lorsque vous ouvrez le couvercle, les voyants clignotent momentanément pour indiquer que le distributeur sait qu'il reste de la nourriture dans le bol. Toutes les lumières disparaîtront pour vous permettre d'ajouter une nouvelle portion fraîche en plus des restes.

2

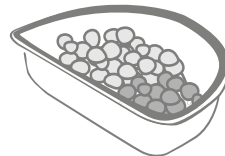

Remplissez le bol jusqu'à ce que tous les témoins d'indication de portion clignotent en vert.



Mode d'apprentissage

(éduquer votre animal à l'utilisation du distributeur de nourriture)



Lorsqu'il est ouvert à l'aide du bouton d'ouverture / fermeture, le voyant du "mode apprentissage" orange clignote en rouge pour vous aider à identifier que le bouton d'ouverture / fermeture a été enfoncé et qu'il est en mode d'ouverture. Le voyant d'apprentissage redeviendra orange lorsque vous appuierez sur le bouton d'ouverture / de fermeture, une fois que vous aurez ajouté la portion d'aliments. **Si vous n'appuyez pas sur le bouton d'ouverture/fermeture, les témoins lumineux ne se déclencheront pas et le système ne sera pas en mesure de reconnaître l'ajout de nourriture.**

ÉTAPE 1 : présentation du distributeur de nourriture à votre animal

Certains animaux domestiques auront peut-être besoin d'un peu de temps pour s'habituer au distributeur de nourriture. Le mode d'apprentissage vous permet d'introduire progressivement de plus en plus de mouvement pour le couvercle, ce qui signifie que votre animal de compagnie peut gagner en confiance pour l'utilisation de sa nouvelle gamelle. Cette étape peut prendre un peu de temps, mais soyez patient et ne passez pas à **L'ÉTAPE 2** tant que votre animal ne semble à l'aise.

1

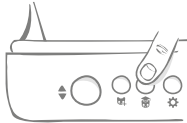

Lorsque le couvercle est fermé, appuyez une fois sur le bouton « Mode d'apprentissage » (🎓) situé à l'arrière du distributeur de nourriture. Le couvercle s'ouvre et le témoin clignote en orange (toutes les quelques secondes).

2

Remplissez le bol de la nourriture préférée de votre animal et placez l'unité à l'emplacement habituel ou dans un endroit où il se sent à l'aise pour manger.

3



Pendant la première phase d'apprentissage de votre animal à l'utilisation du distributeur de nourriture, **le couvercle ne se ferme pas** une fois qu'il a fini de manger.



Soyez patient et laissez à votre animal le temps de s'habituer à son nouveau bol. Une fois qu'il est habitué, passez à ÉTAPE 2.

ÉTAPE 2 : accoutumance aux mouvements du couvercle

L'accoutumance progressive aux mouvements du couvercle se fait en trois étapes. Une fois de plus, pour des résultats optimaux et un animal heureux, soyez patient et ne précipitez pas ce processus. Le temps requis pour chaque étape varie selon l'animal (jours/semaines), nous recommandons néanmoins de réaliser chaque étape sur plusieurs jours.

4

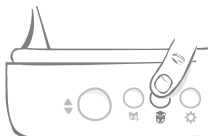

Commencez à augmenter les mouvements du couvercle en appuyant de nouveau sur le bouton « Mode d'apprentissage » (🎓). Le couvercle se ferme partiellement et le témoin arrière clignote deux fois en orange.

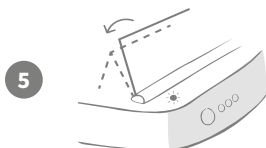

5

Désormais, lorsque votre animal mange dans le bol, un mouvement a lieu car le couvercle s'ouvre complètement. Lorsqu'il a fini de manger, il se referme légèrement.



6

Laissez du temps à votre animal de compagnie pour qu'il s'habitue au mouvement du couvercle. Lorsqu'il est nécessaire de réapprovisionner le bol, procédez de la façon habituelle, **voir page 73**. Suite au réapprovisionnement en nourriture, veillez à appuyer sur le bouton d'ouverture/fermeture (↕) afin de replacer le couvercle en position d'apprentissage.



N'oubliez pas de prendre votre temps. Ne passez pas à l'étape suivante tant que votre animal n'est pas à l'aise avec l'amplitude actuelle de mouvement du couvercle.

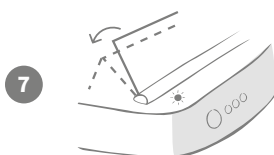

7

Lorsque votre animal est habitué à ce mouvement, appuyez de nouveau sur le bouton « Mode d'apprentissage » (Ⓢ). Le couvercle se ferme jusqu'à la position suivante et le témoin lumineux arrière clignote maintenant trois fois en orange.



Une fois de plus, continuez à utiliser le distributeur de nourriture normalement et ne passez pas à l'étape suivante tant que votre animal n'est pas à l'aise avec ce mouvement.

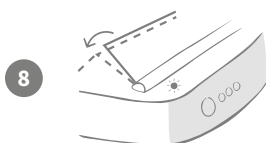

8

Votre animal étant désormais accoutumé aux mouvements du couvercle, le couvercle va se fermer encore plus lors de cette dernière étape d'apprentissage. Comme auparavant, appuyez à nouveau sur le bouton « Mode d'apprentissage » (Ⓢ). Le couvercle se ferme à la dernière position et le témoin lumineux arrière clignote maintenant quatre fois en orange.



9

Une fois que votre animal est habitué à cette dernière position, appuyez de nouveau sur le bouton (Ⓢ). Le couvercle se ferme complètement et le témoin arrière ne clignote plus. Le distributeur de nourriture est maintenant fermé et prêt à fonctionner normalement.



Vous pouvez mettre fin au mode d'apprentissage à tout moment en maintenant le bouton « Mode d'apprentissage » (Ⓢ) enfoncé pendant **5 secondes**.



Si vous devez revenir en arrière, suivez l'astuce ci-dessus. Cette procédure annule le mode d'apprentissage et vous pouvez ensuite recommencer le processus depuis le début.



Si votre animal semble troublé par la fermeture du couvercle une fois qu'il s'est éloigné, il est possible de régler la durée avant la fermeture à partir de l'application Sure Petcare.



Nettoyage et entretien

Il est important de garder votre distributeur de nourriture Connect propre, afin de garantir un fonctionnement fiable. **N'immergez pas l'unité entière dans l'eau et ne la placez pas sous l'eau du robinet ! L'eau peut endommager le distributeur de nourriture et ses composants électroniques.**

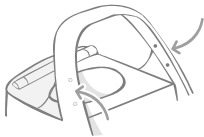
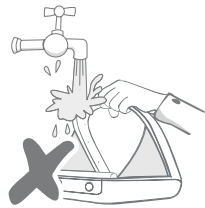

Veillez à toujours maintenir les quatre points noirs sur l'arceau propres. Le tapis peut être nettoyé avec un chiffon humide. **Ne pas mettre au lave-vaisselle. Lavage uniquement à la main.**

Le distributeur de nourriture Connect comprend un **covercle d'accès pour le nettoyage** sur sa base pour enlever facilement les miettes ou déchets alimentaires.

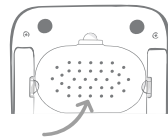

Comment retirer le covercle afin de le nettoyer ?

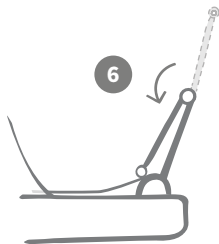

Une fois le covercle installé, repliez la partie supérieure du covercle afin qu'il repose sur l'intérieur des protections latérales.

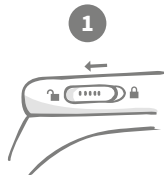

Déplacez le bouton de verrouillage du covercle en position déverrouillée.



Appuyez sur le bouton (↕). Une fois le covercle ouvert, tirez-le vers le haut.

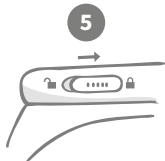

Déplacez le bouton de verrouillage du covercle en position verrouillée.

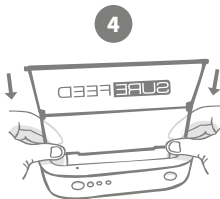

Après l'avoir nettoyé, remplacez le covercle en veillant à bien tenir les deux parties verticalement. Assurez-vous que le covercle est bien installé.



Lavage uniquement à la main. **Ne pas** mettre au lave-vaisselle.

Comment vous assurer que votre distributeur de nourriture reste propre

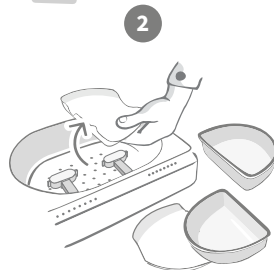

Retirez les bols, support de bols et le couvercle, voir page précédente.



Rattachez toutes les parties, en veillant à **fixer en premier, le couvercle d'accès pour le nettoyage.**

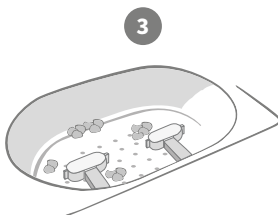

Les déchets alimentaires coincés autour des bras de pesée peuvent affecter les performances du distributeur de nourriture, il est donc très important de maintenir sa propreté. **Ne pas utiliser d'éponges abrasives** car elles peuvent endommager le distributeur de nourriture et l'empêcher de fonctionner correctement.

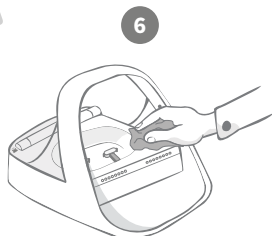

Utilisez un chiffon humide pour vous assurer que toutes les surfaces du distributeur de nourriture sont propres. **Ne pas utiliser de produits nettoyants abrasifs.**

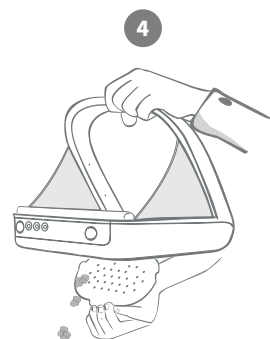

Maintenez le distributeur de nourriture au-dessus du bac, retirez le couvercle d'accès pour le nettoyage et laissez les déchets tomber.

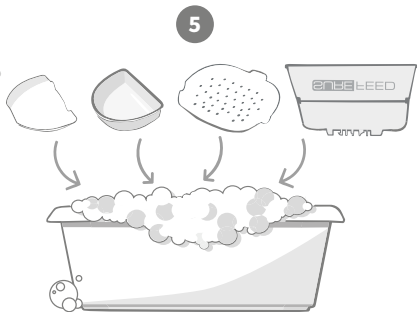

Lavez à la main toutes les **pièces amovibles**. Ne les mettez pas au lave-vaisselle.



Aide et support

Paramètres personnalisés

Nous comprenons que tous les animaux domestiques ne se comportent pas de la même manière, nous avons donc conçu le distributeur de nourriture Connect pour répondre à leurs besoins. Le distributeur de nourriture contient une variété de paramètres personnalisés conçus pour vous aider si vos animaux utilisent le distributeur de manière inattendue ou inhabituelle. Vous trouverez ci-dessous quelques exemples de comportement que les paramètres personnalisés peuvent aider à surmonter :

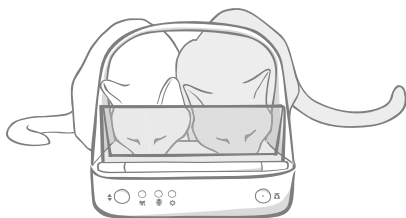

Est-ce qu'un animal domestique non autorisé essaye de manger en même temps que celui autorisé ?

Nous avons un paramètre personnalisé pour ce cas de figure !

Votre animal non autorisé aime-t-il voler la nourriture du distributeur de nourriture d'un autre animal lorsqu'il est en mode d'apprentissage ?

Nous avons un paramètre personnalisé pour ce cas de figure !

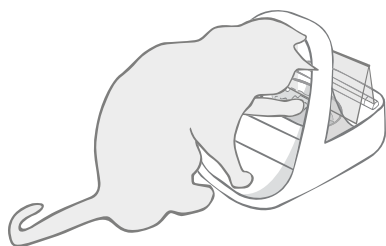

Votre animal trop habile et non autorisé a-t-il trouvé un moyen d'empêcher la fermeture du couvercle ?

Nous avons un paramètre personnalisé pour ce cas de figure !

Votre animal non autorisé essaie-t-il de voler de la nourriture à l'arrière du distributeur ?

Nous avons un accessoire pour ce cas de figure !

Rendez-vous sur [surepetcare.com/accessoires](https://www.surepetcare.com/accessoires) et recherchez le cache arrière.

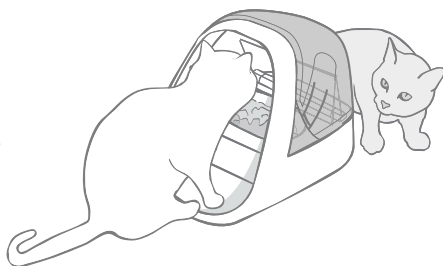

Veillez contacter notre service client pour discuter des paramètres personnalisés, **voir à la fin du guide pour plus de détails**. Il sera en mesure de recommander le paramètre personnalisé le plus approprié à votre situation et de le configurer pour vous à distance.

Le hub

Témoins clignotant en rouge

Votre hub a perdu la connexion avec le distributeur de nourriture Connect.

- Si les **deux oreilles clignotent en rouge pendant la configuration**, restaurez la configuration d'usine en appuyant sur le bouton à la base du hub pendant 10 secondes.
- Si les **deux oreilles clignotent en rouge de façon prolongée après la configuration**, éteignez et rallumez successivement votre hub. Éteignez l'interrupteur de la prise, patientez une trentaine de secondes et rallumez-le. Si les oreilles affichent une couleur verte continue pendant quelques minutes, cela signifie que le hub s'est reconnecté.
- Vous pouvez aussi tenter de **changer l'emplacement de votre hub** en suivant les conseils de la **page 65**. Si le problème persiste, approchez le hub de votre distributeur de nourriture, comme précisé ci-dessous.
- Pour rapprocher votre hub, essayez de le connecter à votre routeur en utilisant un câble Ethernet plus long.
- Si cette solution n'aboutit pas, nous vous recommandons d'acheter « **un adaptateur Ethernet CPL** ». Il se branchera dans une prise murale et vous permettra de connecter votre hub au réseau Internet à proximité de l'emplacement de votre distributeur de nourriture.

Témoins clignotant en alternant (rouge ou vert)

Votre hub rencontre des problèmes en essayant de se connecter aux serveurs Sure Petcare. Ce cas de figure peut être dû à une mauvaise connexion Internet.

- Réinitialisez le hub en éteignant l'interrupteur de la prise, patientez une trentaine de secondes et rallumez-le. Si les témoins latéraux affichent une couleur verte continue pendant quelques minutes, cela signifie que le hub s'est reconnecté.
- Si le problème persiste, vérifiez que le routeur Internet est allumé et que la connexion Internet fonctionne correctement sur vos autres dispositifs.
- Si aucun autre dispositif ne peut se connecter à Internet, éteignez votre routeur et rallumez-le au bout de 30 secondes.
- Si votre routeur fonctionne avec les autres dispositifs, rebranchez le câble Ethernet dans le routeur et le hub. Assurez-vous qu'il est parfaitement enclenché car il peut sembler connecté alors qu'il ne l'est pas.

Si vos problèmes de connectivité persistent, rendez-vous sur : surepetcare.com/hub-connectivity

Témoins rouges en continu

Le microprogramme de votre hub est en cours de mise à jour. Veuillez patienter le temps que les témoins latéraux deviennent verts. Cela devrait prendre deux minutes maximum. Une fois la mise à jour du microprogramme terminée, le hub redémarrera. La séquence lumineuse propre à la configuration se produira, **voir page 66**.

Notifications lentes

Si certains messages s'affichent lentement dans votre application, ce cas de figure est probablement dû aux difficultés de connexion entre votre hub et le distributeur de nourriture Connect. Pour améliorer l'affichage des messages, placez votre hub dans un endroit bénéficiant d'une meilleure réception en suivant les conseils prodigués à la **page 65**.

Distributeur de Nourriture Connect

Si votre distributeur de nourriture présente des problèmes mécaniques, n'essayez pas de les résoudre vous-même. Contactez notre service clientèle. Vous trouverez les coordonnées à la **fin de ce guide**.

Le distributeur de nourriture ne s'ouvre pas pour mon animal domestique

- Assurez-vous que les quatre capteurs situés à l'intérieur de l'arceau soient propres, **consultez la page 77**.
- Assurez-vous d'avoir utilisé des piles **alcalines** de qualité et vérifiez leur puissance. Assurez-vous que le +/- des piles soient dans le bon sens, **voir page 67**.
- Éloignez le distributeur de tout appareil métallique ou électrique. Si le distributeur de nourriture ne s'ouvre toujours pas pour votre animal domestique autorisé, continuez à lire.
- Assurez-vous qu'il n'existe pas de sources de parasites électriques à proximité, comme une lumière défectueuse qui clignote, etc. Si tel est le cas, veuillez contacter notre service clientèle. **Pour plus d'informations, consultez la quatrième de couverture**.
- Si cela ne fonctionne pas, veuillez vérifier avec votre vétérinaire si la puce électronique de votre animal fonctionne et se situe à l'emplacement normal. Si la puce a bougé considérablement, elle sera difficile à lire. En attendant, vous pouvez utiliser le médaillon d'identification par radiofréquence Sure Petcare fourni. Fixez le médaillon sur le collier de votre animal et répétez le processus d'«Ajout d'un animal», **voir page 71**.

Mon animal n'aime pas utiliser le distributeur de nourriture

- Répétez le processus d'apprentissage en donnant plus de temps à votre animal entre chaque étape pour qu'il s'habitue plus facilement, **voir page 75-76**.
- Si votre animal reste particulièrement hésitant, essayez les recommandations indiquées sur **surepetcare.com/cautiouspet** mais il est important de ne jamais le forcer.
- Analysez le comportement de votre animal. Se dirige-t-il vers le bol toujours de la même façon ? Être dos à la porte représente-t-il une source d'inconfort pour lui ? Le distributeur peut être orienté dans tous les angles. N'hésitez pas à le placer selon les préférences de votre animal.
- Si le délai de fermeture du couvercle (une fois que l'animal a fini de manger et s'est éloigné du distributeur) n'est pas adapté à l'animal, vous pouvez l'augmenter/le diminuer à partir de l'application Sure Petcare.

Le couvercle du distributeur ne se ferme pas complètement

- Ce problème est probablement dû à des restes alimentaires coincés en dessous du couvercle ou à l'intérieur du mécanisme. Pour s'assurer que le couvercle continue de se refermer correctement, veillez à retirer tous les déchets alimentaires des différentes surfaces du distributeur, **voir page 77-78**.
- Assurez-vous de ne pas être en mode apprentissage. **Consultez la page 75** pour en savoir plus sur le mode entraînement.

Les témoins d'indication de portion sont allumés mais le bol est vide

Si, lorsque vous ouvrez le distributeur de nourriture, certains témoins d'indication de portion sont verts, alors qu'il ne reste plus de nourriture dans les bols, cela indique que vous devez effectuer la réinitialisation. Pour résoudre ce problème, assurez-vous de toujours appuyer sur le bouton de « remise à zéro » avant de remplacer la nourriture de votre animal, **voir page 73-74**.

Les témoins d'indication de portion ne répondent pas

- Veuillez noter que si vous n'avez pas défini de poids de portion dans l'application Sure Petcare, les témoins lumineux d'indication de portion ne s'allument pas lorsque vous ajouterez de la nourriture.
- De plus, les déchets alimentaires coincés autour des bras de pesée peuvent affecter les performances du distributeur de nourriture, il est donc très important de le maintenir propre, voir **page 77-78**.

D'autres animaux volent la nourriture

- Si des animaux gourmands essayent de voler la nourriture dans le distributeur ouvert, essayez de réduire le délai de fermeture du couvercle après que l'animal ait fini de manger à partir de l'application Sure Petcare.
- Il est possible qu'un paramètre personnalisé aide à résoudre le problème que vous rencontrez. Veuillez contacter notre service clientèle pour discuter de votre situation, **consultez la quatrième de couverture pour plus de détails**.
- Alternativement, si les animaux gourmands réussissent à voler de la nourriture en passant par l'arrière ou sur les côtés du distributeur de nourriture (lorsque le couvercle est ouvert et que l'animal autorisé est en train de manger), nous avons créé un cache arrière qui vous aidera à stopper ce comportement déterminé. Pour plus d'informations, rendez-vous sur **surepetcare.com/accessoires**.

Faible autonomie des piles

- Assurez-vous que le distributeur de nourriture soit propre et qu'il n'y ait pas de saleté occultant les capteurs, **voir la page 77**.
- Assurez-vous d'avoir installé des piles alcalines de qualité en respectant les consignes d'insertion, **voir page 67**.
- Assurez-vous qu'il n'existe pas de sources de parasites électriques à proximité, comme une lumière défectueuse qui clignote, etc. Si tel est le cas, veuillez contacter notre service clientèle. **Consultez la quatrième de couverture** pour plus de détails.

Plusieurs distributeurs de nourriture dans un seul foyer

- Si vos animaux se perdent parmi les différents distributeurs, essayez d'utiliser des bols de couleurs différentes ainsi que des emplacements différents plus distincts. Cette technique devrait aider vos animaux à se repérer. Des bols et des tapis de couleurs différentes sont vendus séparément. Pour plus d'informations, rendez-vous sur **surepetcare.com/accessoires**.

Toujours besoin d'aide ?



- Si vos problèmes de connectivité persistent, rendez-vous sur : **surepetcare.com/hub-connectivity**
- Pour obtenir des directives plus détaillées ainsi que des vidéos et profiter des forums d'aide aux clients, rendez-vous sur : **surepetcare.com/assistance**
- Si vous rencontrez des problèmes avec votre application Sure Petcare, rendez-vous sur : **surepetcare.com/apphelp**

Vous pouvez également appeler notre service clientèle. **Consultez la quatrième de couverture pour plus de détails.**



Garantie et clause de non-responsabilité

Garantie : le distributeur de nourriture à puce électronique SureFeed est garanti 3 ans à compter de la date d'achat, à condition de fournir une preuve d'achat. La garantie couvre uniquement les composants et matériaux défectueux et les défauts de fabrication. Cette garantie ne couvre pas les défauts liés à l'usure, à une mauvaise utilisation, à la négligence ou aux dommages intentionnels. En cas de défaillance liée à une pièce défectueuse ou un défaut de fabrication, la pièce sera remplacée gratuitement uniquement pendant la période de garantie. À la seule discrétion du fabricant, le produit pourra être remplacé gratuitement en cas de dysfonctionnement important. Cela ne saurait porter préjudice à vos droits statutaires.

Clauses de non responsabilité : le distributeur de nourriture Connect et l'application signalent le niveau de consommation d'aliments en détectant la puce électronique et en mesurant ensuite le poids du bol avant et après la consommation. Dans la plupart des cas, cela vous donnera des informations fiables concernant la consommation de votre animal. Cela dit, un usage inattendu ou inhabituel du distributeur de nourriture (par exemple, un animal qui retire le bol ou joue avec sa nourriture) risque de fausser les informations. Sure Petcare décline toute responsabilité quant aux éventuels dommages ou désagréments qui pourraient résulter d'une mauvaise information concernant la consommation d'un animal.

Le distributeur de nourriture Connect SureFeed intègre des fonctions d'accès sélectif conçues pour minimiser le risque que les animaux ne se volent mutuellement la nourriture. Il est néanmoins impossible de garantir à 100 % l'exclusion des autres animaux en toutes circonstances. Dans le cas où un animal non autorisé parviendrait à accéder au distributeur de nourriture, Sure Petcare décline toute responsabilité quant aux éventuels dommages ou désagréments qui pourraient en résulter.



Élimination des produits et des piles usagées : cette icône indique que le produit est soumis à la législation suivante :

La Directive 2012/19/UE relative aux déchets d'équipements électriques et électroniques (dite Directive DEEE) et la Directive relative aux piles 2006/66/UE, ainsi que son amendement 2013/56/UE, imposent aux foyers d'éliminer les piles usagées et les produits qui ont atteint la fin de leur vie d'une manière respectueuse de l'environnement afin de réduire leur impact écologique. Ils ne peuvent donc pas être jetés dans la poubelle domestique et doivent être remis à un établissement de recyclage approprié pour y être recyclés. Vous trouverez des informations supplémentaires concernant le recyclage sur : <https://www.eco-systemes.fr/>

Veillez à remplacer les piles avant la date d'expiration figurant sur l'emballage ou la pile, et veillez à les éliminer correctement et en toute sécurité.

En cas de fuite des piles, portez un équipement de protection approprié pour vous protéger d'une éventuelle exposition à des substances chimiques nocives avant d'éliminer les piles et de nettoyer les éventuels déversements. Évitez tout contact avec la peau lorsque vous nettoyez un déversement. Les substances chimiques des piles ne doivent pas être placées près des yeux ou ingérées. Contactez immédiatement un professionnel de santé si un tel cas de figure venait à se produire.

IC compliance: CAN ICES-3(B)/NMB-3(B) : This device complies with Industry Canada license-exempt RSS standards. Operation is subject to the following two conditions:

- (1) this device may not cause interference, and
- (2) this device must accept any interference received, including interference that may cause undesired operation of the device.

To meet RF exposure guidelines, a separation distance of 200 mm should be maintained. This device complies with the safety requirements for RF exposure in accordance with RSS-102 Issue 5 for portable use conditions.

Conformité IC: CAN ICES-3(B)/NMB-3(B) : Le présent appareil est conforme aux CNR d'Industrie Canada applicables aux appareils radio exempts de licence. L'exploitation est autorisée aux deux conditions suivantes :

- (1) l'appareil ne doit pas produire de brouillage, et
- (2) l'utilisateur de l'appareil doit accepter tout brouillage radioélectrique subi, même si le brouillage est susceptible d'en compromettre le fonctionnement.

Pour respecter les consignes d'exposition aux RF, une distance de séparation de 200 mm doit être maintenue. Cet appareil est conforme aux exigences de sécurité concernant l'exposition aux RF selon la norme RSS-102, 5ème édition, pour des conditions d'utilisation portable.

Marques déposées : Google Play et le logo Google Play sont des marques déposées de Google Inc. Apple est une marque déposée d'Apple Inc., enregistrée aux États-Unis et dans d'autres pays. App Store est une marque de service d'Apple Inc., enregistrée aux États-Unis et dans d'autres pays. IOS est une marque commerciale ou une marque déposée de Cisco aux États-Unis et dans d'autres pays et est utilisée sous licence.



SURE™
PETCARE

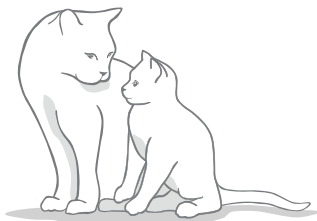

Welkom bij uw nieuwe Microchip Voerbak Connect

Bedankt dat u hebt gekozen voor de Microchip Voerbak Connect!

Het Microchip Voerbak Connect-systeem bestaat uit drie samenwerkende onderdelen die u meer inzicht geven in de eetgewoontes van uw huisdier.

De **Microchip Voerbak Connect** is het hoofdonderdeel van het systeem. Deze voerbak herkent de geprogrammeerde chip van uw huisdier of de Sure Petcare RFID-penning (één inbegrepen), zodat alleen dit huisdier bij het eten kan.

De **hub** (apart verkrijgbaar) is het verbindingselement van het systeem. De hub maakt gebruik van uw bestaande internetverbinding en communiceert met zowel de voerbak als uw Sure Petcare-app.

Via de **Sure Petcare-app** kunt u controleren hoeveel uw huisdier heeft gegeten en hoe vaak uw huisdier de voerbak bezoekt. Met de app kunt u ook een portiegewicht naar de voerbak sturen, zodat u de hoeveelheid voedsel per portie kunt regelen.

Inhoud van de doos

Controleer of alle volgende onderdelen aanwezig zijn*

- 1 Microchip Voerbak Connect
- 2 1 enkel bakje
- 3 2 halve bakjes
- 4 1 mat
- 5 1 houder voor enkel bakje
- 6 2 houders voor halve bakjes
- 7 1 Sure Petcare RFID-penning

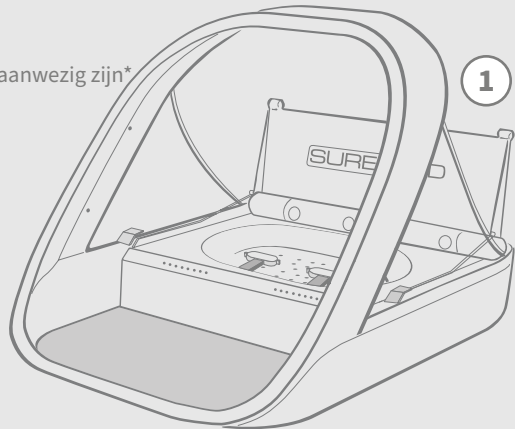

*Batterijen en hub zijn niet inbegrepen.

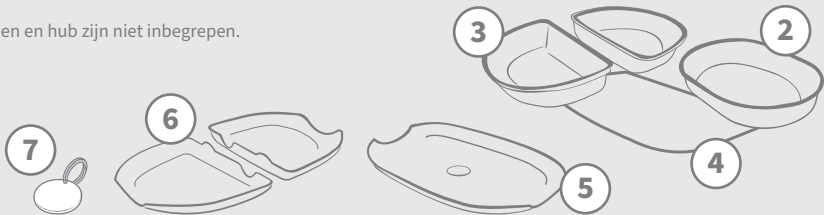

Als u de Microchip Voerbak Connect met de Sure Petcare App wilt gebruiken, moet u een bijbehorende hub aanschaffen. Meer informatie over de aanschaf van een hub vindt u op surepetcare.com/hub

Inhoud

Belangrijke informatie	87
Productoverzicht.....	89
Microchip Voerbak Connect-systeem	91
Hub	
Uw hub installeren	92
Uw hub plaatsen	93
Lampjes van de hub	94
Voerbak	
Batterijen.....	95
De voerbak verbinden.....	96
Knoppen en lampjes	97
Uw huisdier aan de voerbak toevoegen.....	99
Porties instellen	100
Voer toevoegen en vervangen	101
Trainingsmodus	103
Reiniging en onderhoud	105
Help en ondersteuning.....	107
Garantie en disclaimer	111



Belangrijke informatie



LEES DE VOLGENDE INFORMATIE AANDACHTIG DOOR EN BEWAAR DEZE HANDLEIDING VOOR TOEKOMSTIG GEBRUIK.



Dit product is **alleen bedoeld voor huisdieren**.



Gebruik alleen SureFeed-accessoires om compatibiliteit te garanderen: surepetcare.com/accessoires



Controleer of u alle onderdelen hebt die worden vermeld op **pagina 85**.



Plaats de voerbak niet op een plek waar vaak mensen langslopen.



De voerbak kan **alleen binnenshuis worden gebruikt**.



Dompel de voerbak niet onder in water en zet hem niet onder een lopende kraan.



Zet de voerbak niet in de koelkast en plaats geen ijszakken onder of in de voerbak.



Plaats de voerbak niet op een plek waar hij wordt blootgesteld aan extreme hitte.



Er zijn vier C-batterijen vereist voor dit product, die voorzichtig moeten worden geplaatst en vervangen. Combineer geen verschillende typen batterijen of nieuwe en gebruikte batterijen. Als de voerbak langere tijd niet gebruikt wordt, moet u de batterijen verwijderen.

U vindt de **productcode** en het **serienummer** van de Microchip Voerbak Connect op de onderkant van het product.

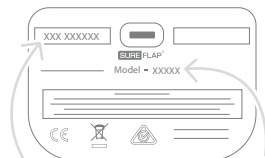

Serienummer

Productcode

Veiligheidswaarschuwingen

- **Gebruik dit product niet** als er onderdelen ontbreken of beschadigd of versleten zijn.
- **Dit product bevat kleine onderdelen.** Houd losse onderdelen uit de buurt van jonge kinderen en huisdieren om **verstikkingsgevaar te voorkomen**.

Andere belangrijke zaken om rekening mee te houden



HUISDIEREN: Sure Petcare raadt aan de Surefeed Microchip Voerbak Connect te gebruiken met de geïmplanteerde microchip van uw huisdier. Maar u kunt hem ook gebruiken met de Sure Petcare RFID-penning. Als u de penning gebruikt, moet u dit alleen doen met een **veiligheidshalsband die een gemakkelijk te openen gesp heeft** (alleen katten). Sure Petcare is niet aansprakelijk voor (dodelijke) verwondingen van huisdieren veroorzaakt door hun halsband.



TOEGANG TOT HET VOER: Sure Petcare kan geen aansprakelijkheid aanvaarden voor toegang verkregen door een ander huisdier als gevolg van onbedoeld gebruik. Als eigenaar van dit product, **aanvaardt u de volledige verantwoordelijkheid voor het toezicht op de toediening van voer**, dat bij onbedoelde consumptie andere huisdieren schade kan toebrengen.



GEEN TIMERFUNCTIE: Dit product bevat geen timer en **heeft geen tijdgerelateerde functies**. Laat uw huisdier daarom niet zonder toezicht achter en vertrouw niet op dit product om ze gedurende langere tijd van voedsel te voorzien: niet langer dan 24 uur voor een kat en de gemiddelde tijd tussen maaltijden voor een kleine hond. **Dit product is geen vervanging voor verantwoordelijke omgang met huisdieren.**



KINDEREN: Laat kinderen **niet spelen met de SureFeed Microchip Voerbak Connect**. Het is geen speelgoed en moet ook niet als zodanig worden beschouwd. Dit product mag echter worden gebruikt door kinderen van 8 jaar en ouder, en door mensen met lichamelijke, zintuiglijke of geestelijke beperkingen, mits onder toezicht of als ze instructies hebben gekregen over veilig gebruik van het product. Ze moeten zich te allen tijde bewust zijn van de mogelijke gevaren. Laat kinderen (ongeacht de leeftijd) het product niet zonder toezicht schoonmaken.



VEILIGHEID VOOR KINDEREN: In huishoudens met kinderen is het van essentieel belang **om bij maatregelen voor de bescherming van kinderen ook rekening te houden met de SureFeed Microchip Voerbak Connect**. Verkeerd gebruik van dit product door een kind kan gevaarlijk zijn voor het kind. Daarom moeten jonge kinderen in de buurt van de voerbak altijd in de gaten worden gehouden. Houd er ook rekening mee dat wanneer de voerbak in **trainingsmodus staat (zie pagina 103-104)**, **een kind toegang heeft tot het voer van het huisdier.**



Productoverzicht

Het Microchip Voerbak Connect-systeem bestaat uit drie hoofdonderdelen:

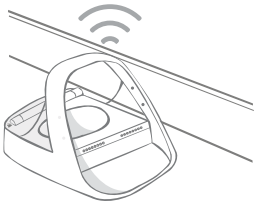

Microchip Voerbak Connect



Hub

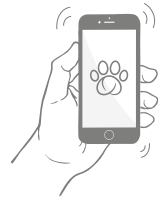

Sure Petcare app

De hub is via een ethernet-kabel met internet verbonden om de activiteit van uw Microchip Voerbak te controleren. De hub communiceert met zowel de voerbak als de Sure Petcare-app, zodat u updates kunt bekijken op de Sure Petcare-app, zelfs wanneer u niet thuis bent.

U kunt ook een portiegewicht in de app instellen. Wanneer u dit hebt ingesteld, begeleidt de voerbak u wanneer u voer toevoegt om ervoor te zorgen dat uw huisdier de juiste hoeveelheid krijgt. **Zie pagina 98** voor meer informatie.

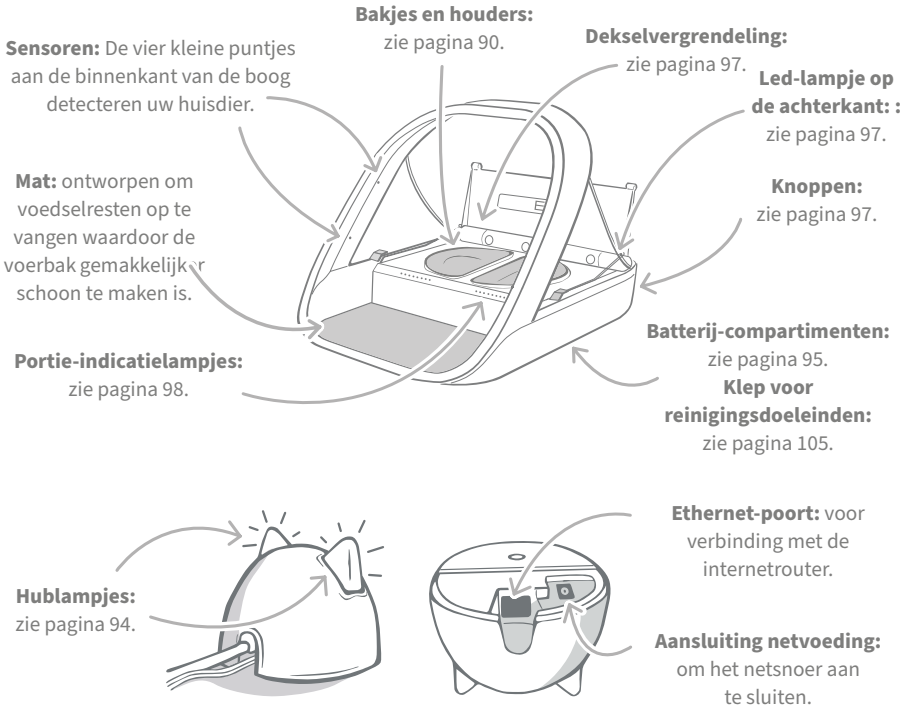

De SureFeed-bakjes hebben een geïntegreerde afdichting aan de bovenrand zodat het voer langer vers blijft. Als u uw huisdier maar één soort voer geeft, kunt u het enkele bakje gebruiken. Als u echter zowel nat- als droogvoer geeft, dan zijn de halve bakjes hier perfect voor.



Enkel bakje: geschikt voor 250 g, wat voldoende is voor ten minste 2 zakjes natvoer.



Halve bakjes: elk bakje kan maximaal 100 g bevatten, of 200 g in beide bakjes samen.

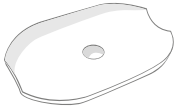

Houder voor enkel bakje: is geschikt voor het enkele bakje (niet de halve bakjes).



Houders voor halve bakjes: elke houder is geschikt voor een half bakje (niet het enkele bakje).

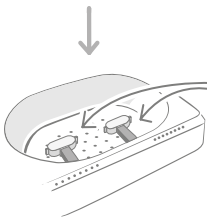

Weegarmen: ontworpen om de bakhouder te ondersteunen.

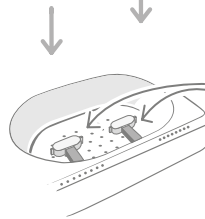

Weegarmen: ontworpen om de bakhouders te ondersteunen.

Plaats het voer voor uw huisdier niet in de bakhouders. Gebruik altijd de bakjes. Alleen dan werkt de voerbak zoals het hoort.



De gesplitste bak van SureFeed is niet bedoeld voor gebruik met de Microchip Voerbak Connect.

Als u extra bakken of matten wilt aanschaffen, neemt u contact op met een Sure Petcare-verkoper of gaat u naar surepetcare.com

Voeg wat kleur toe

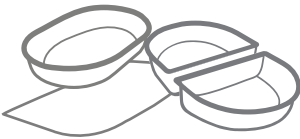

De plastic bakjes en matten van SureFeed zijn verkrijgbaar in vier verschillende kleuren: blauw, groen, roze en grijs.

Of voeg wat glans toe

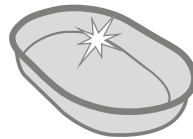

Het enkele bakje van SureFeed is ook in roestvrijstaal verkrijgbaar.



De bakjes zijn niet geschikt voor de vaatwasser en magnetron.



Was de bakjes met de hand af voordat u ze voor de eerste keer gebruikt.



Microchip Voerbak Connect-systeem

Download nu gratis de Sure Petcare-app

DOWNLOAD IN DE
APP STORE

ONTDEK HET OP
GOOGLE PLAY

 surepetcare.io



Ontvang meldingen wanneer uw huisdier uit de voerbak eet.



Houd de eetgewoonten van uw huisdier in de gaten en krijg inzicht in eventuele veranderingen.



Bepaal nauwkeurig wat een portie is om te regelen wat per keer gegeten mag worden.



Deel de toegang tot uw huishouden met familie en vrienden.



Download de **Sure Petcare-app** en maak een account. U wordt gevraagd een 'huishouden' te maken (dit is een netwerk met al uw verbonden Sure Petcare-producten en al uw huisdieren). U kunt andere gezinsleden uitnodigen om deel te nemen aan het huishouden.

Als u de app wilt gebruiken, moet uw telefoon of tablet minimaal **iOS 9** op **Apple** of **4.4** op **Android** hebben.



Als u uw verbonden Sure Petcare-producten liever vanaf uw computer regelt, kunt u de Sure Petcare-webapp op **surepetcar.io** gebruiken.

U moet de nieuwste versie hebben van Safari, Chrome, Firefox of **Internet Explorer** op **Mac OS X v10.9** (of hoger) of **Windows 7** (of hoger).

Een Sure Petcare Hub aanschaffen



Als u de Microchip Voerbak Connect met de Sure Petcare-app wilt gebruiken, moet u de bijbehorende hub aanschaffen. Ga voor meer informatie naar surepetcare.com/hub



Uw hub installeren

Nadat u de Sure Petcare-app hebt gedownload, moet u uw hub aansluiten en installeren. Wanneer uw hub is geïnstalleerd, wordt u gevraagd om deze te verbinden met zowel de voerbak als de app. Voer de onderstaande stappen uit:

1

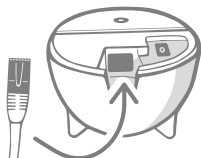

Sluit het ene uiteinde van de ethernet-kabel aan op de onderkant van uw hub en het andere uiteinde op een vrije ethernet-poort van uw router.

2

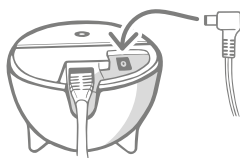

Stel de voedingskabel samen en steek deze in uw stopcontact. Sluit het andere uiteinde van de kabel aan op de onderkant van uw hub.

3

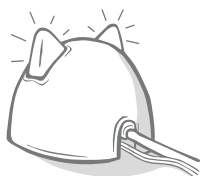

De 'oren' van uw hub worden **afwisselend rood en groen**. Wanneer beide oren groen blijven branden, is uw hub klaar. Als de oren dit niet doen, **gaat u naar pagina 94** voor meer informatie..

4



U moet de resterende stappen op de Sure Petcare-app doorlopen om de installatie van uw Microchip Voerbak Connect-systeem te voltooien.



Uw hub ontvangt mogelijk een software-update. Als er **rode lampjes branden**, geen paniek, uw hub is de software aan het bijwerken. Zodra de update is voltooid, wordt de hub opnieuw gestart en lichten de lampjes op zoals beschreven in stap 3.



Uw hub plaatsen

Omdat uw Microchip Voerbak Connect-systeem draadloos communiceert, is de locatie van uw hub van invloed op de werking ervan.



Plaats de hub ten minste 1 meter van de grond, bijvoorbeeld op een tafel waar zich zo weinig mogelijk obstakels bevinden.

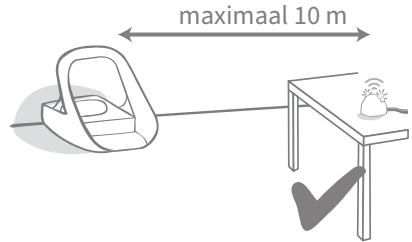

Plaats indien mogelijk de hub in de gezichtslijn van uw voerbak en binnen een straal van 10 meter.

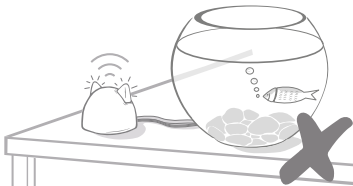

Plaats uw hub ook niet dicht bij of in een gezichtslijn met een grote hoeveelheid water, zoals een aquarium.

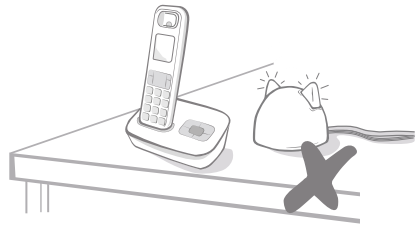

Houd uw hub zo ver mogelijk verwijderd van mogelijke storingsbronnen, (bijvoorbeeld digitale draadloze telefoons, babyfoons enzovoort).



Zorg dat u de hub niet naast grote, metalen voorwerpen plaatst, zoals een ijskast.

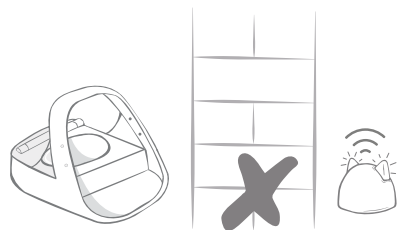

Er mag geen dikke muur tussen de hub en de voerbak zijn.



Zelfs als u deze richtlijnen volgt, ondervindt uw hub mogelijk af en toe verbindingproblemen. Voor verder advies over hoe u uw hub dichterbij uw Microchip Voerbak Connect plaatst, gaat u naar surepetcare.com/hub-connectivity



Als de internetverbinding met uw hub wordt verbroken, blijft uw Microchip Voerbak Connect gewoon werken en blijven de instellingen behouden.



Lampjes van de hub

De oren van de hub geven door middel van gekleurde lichtjes de huidige staat aan. Verschillende combinaties van gekleurde lichtjes hebben verschillende betekenissen.

Instellingslampjes

Telkens wanneer de hub wordt ingeschakeld of met andere systeemelementen verbinding probeert te maken, lichten de instellingslampjes op:

- 1** De oren branden eerst een tijdje afwisselend rood.

- 2** en dan afwisselend groen.

- 3** Wanneer het lampje oranje knippert en de oren daarna groen blijven branden, is de hub verbonden.



Groene oren

Groene oren betekenen dat de hub goed werkt. Lees hieronder wat de lampjes betekenen.

Beide oren blijven groen branden: de hub is ingeschakeld, verbonden en werkt goed.

Afwisselende groene oren: de hub maakt opnieuw verbinding met onze servers.

Rode oren

Beide oren blijven rood branden: de hub voert een software-update uit. Een ogenblik geduld, uw hub wordt opnieuw gestart en zal snel weer normaal werken.

Beide oren knipperen rood: de verbinding van de hub met de voerbak is verbroken en de hub probeert opnieuw verbinding te maken.

Afwisselende rode oren: de hub kan geen verbinding maken met internet en/of de servers.

- i** Zie pagina 108 voor meer informatie over het analyseren van deze problemen.



Batterijen

Gebruik altijd **4 1,5V-alkalinebatterijen (C-cel) van goede kwaliteit**. Dit zorgt voor de beste prestaties van de Microchip Voerbak Connect. **Dit product is NIET ontworpen voor gebruik met oplaadbare batterijen**. Voer de onderstaande stappen uit om de batterijen te plaatsen of vervangen:

i Er zit een lampje aan de achterkant van de voerbak. Als de batterijen bijna leeg zijn of als ze niet correct zijn geplaatst, knippert dit lampje om de 5 seconden rood.

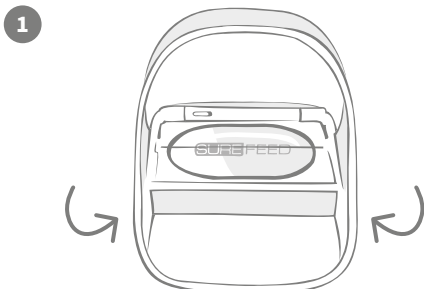

Draai de voerbak op zijn kop om bij het batterijcompartiment te kunnen.

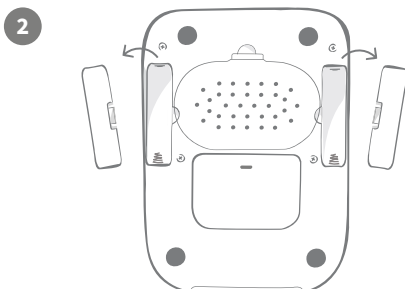

Verwijder de batterijklepjes.

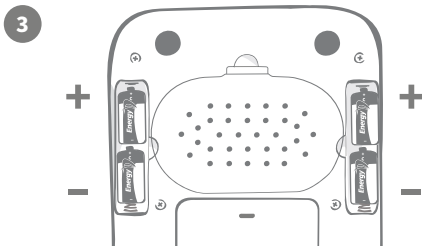

Plaats de batterijen. Let er hierbij op dat de + en - van de batterijen overeenkomen met de + en - op de voerbak zelf.

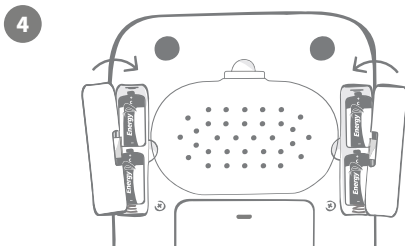

Plaats de batterijklepjes terug.



Wanneer u de chip van uw huisdier in de voerbak programmeert, wordt het chipnummer permanent in het geheugen opgeslagen. Dit betekent dat zelfs als u de batterijen vervangt, de voerbak de chip van uw huisdier nog steeds zal herkennen.



De voerbak verbinden

U moet uw voerbak met uw huishouden verbinden om de installatie van uw verbonden systeem te voltooien.

1

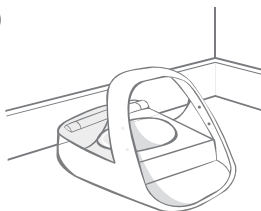

Zet de voerbak op de gewenste plek. Zorg dat de voerbak kan communiceren met de hub.

2



Selecteer **Product toevoegen** in de Sure Petcare-app.

3



De hub schakelt naar de verbindingmodus en de oren beginnen groen te knipperen.

4

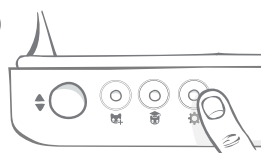

Druk eenmaal op de instellingenknop  op de voerbak. Het oorlampje gaat groen branden.

5

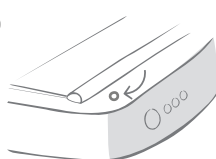

Wanneer de voerbak is verbonden, gaat het lampje uit en stopt de hub met knipperen.

i

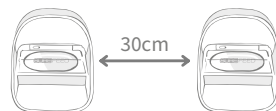

Als u meer voerbakken wilt verbinden, kunt u dit eenvoudig doen vanuit de app.

Een voerbak toevoegen aan uw huidige huishouden



U kunt via de app een Microchip Voerbak Connect toevoegen aan uw bestaande Sure Petcare-huishouden. Ga naar het gedeelte Huishouden en volg de bovenstaande instructies.

U kunt het chipnummer van uw huisdier ook op afstand toewijzen via de app. Dit betekent dat u een chipnummer niet handmatig hoeft toe te voegen. Wanneer u dit echter handmatig doet met behulp van snoepjes, kunt u uw huisdier alvast aanmoedigen het nieuwe product te gebruiken.

Zie pagina 99 voor meer informatie over het toevoegen van huisdieren.



Knoppen en lampjes

Knoppen

De voerbak heeft vijf knoppen. U vindt deze op de achterkant.

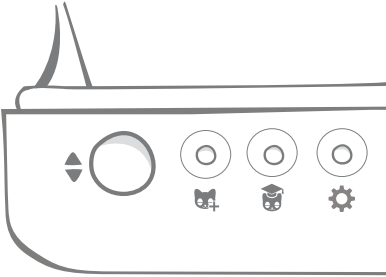

Open- en sluitknop: hiermee opent u het deksel zodat u bij de bak(jes) kunt.



Knop Huisdier toevoegen: hiermee voegt u het chipnummer van uw huisdier aan de voerbak toe, **zie pagina 99.**



Knop voor trainingsmodus: hiermee activeert u de trainingsmodus om uw huisdier te leren de voerbak te gebruiken, **zie pagina 103-104.**



Instellingenknop: hiermee verbindt u de voerbak en de hub, **zie pagina 96.**



Nulknop: hiermee kalibreert u de voerbak zodat u zeker weet dat u de juiste hoeveelheid voer geeft, **zie pagina 101.** Met deze knop zet u **beide zijden van de voerbak op nul, of u nu een enkel bakje of halve bakjes gebruikt.**



Wanneer u halve bakjes gebruikt en u ze apart op nul wilt zetten, kunt u dit doen met de **Sure Petcare-app.**

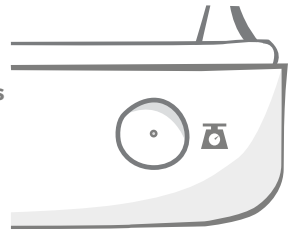

Dekselvergrendeling



Vergrendeld: dit betekent dat u het deksel niet van de voerbak kunt trekken en verwijderen.



Ontgrendeld: wanneer het deksel geopend is, kunt u eraan trekken om het te verwijderen.

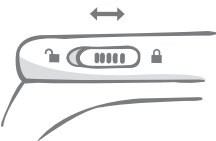
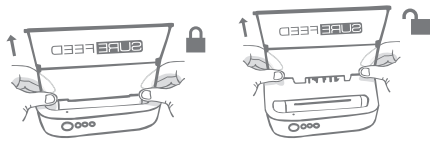

De dekselvergrendeling moet te allen tijde vergrendeld blijven en alleen ontgrendeld worden wanneer u het deksel wilt verwijderen om de voerbak schoon te maken. Zo kan worden voorkomen dat zeer slimme, niet-geregistreerde huisdieren proberen het deksel te verwijderen om bij het voer te kunnen. **Houd er rekening mee dat dit niet verhindert dat het deksel opengaat.**

Led-lampje op achterkant

Brandt groen. Het groene lampje gaat branden telkens wanneer een geregistreerd huisdier uit de voerbak eet.

Knippert groen. De voerbak bevindt zich in de modus 'Een huisdier toevoegen', zie pagina 99. Het lampje blijft knipperen totdat een chip wordt toegevoegd of totdat u de modus verlaat.

Knippert oranje. De voerbak bevindt zich in trainingsmodus, zie pagina 103-104. Het stadium van de training wordt aangegeven door het aantal knipperingen van het lampje.

Knippert rood. De batterijen zijn bijna leeg.

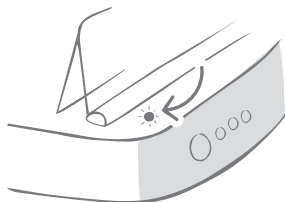

Portie-indicatielampjes

Als u een portiegewicht hebt ingesteld in de Sure Petcare-app, functioneren de lampjes aan de voorkant van de voerbak als richtlijn bij het toevoegen van voedsel.

De portie-indicatielampjes geven de hoeveelheid voer aan die u hebt toegevoegd, zodat u zeker weet dat uw huisdier de juiste hoeveelheid krijgt.

Zie pagina 100 voor meer informatie over de voordelen van nauwkeurige porties.

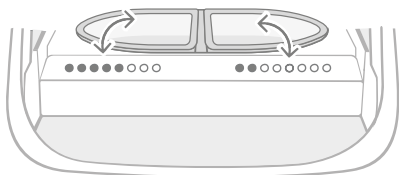
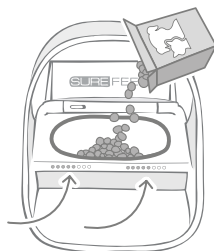

Halve bakjes gebruiken

De lampjes aan de rechterkant van de voerbak horen bij het bakje rechts en de lampjes links horen bij het linkerbakje. De lampjes gaan branden wanneer links of rechts voer wordt toegevoegd.

Het enkele bakje gebruiken

Beide sets lampjes gaan tegelijkertijd aan wanneer er voer wordt toegevoegd aan het enkele bakje.

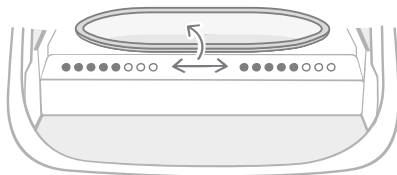

Als u van halve bakjes naar een enkel bakje wilt overschakelen of omgekeerd, kunt u dit doen via de Sure Petcare-app.



Als u in de app geen portiegewicht hebt ingesteld, gaan de lampjes niet branden wanneer voer aan de voerbak wordt toegevoegd.



Uw huisdier aan de voerbak toevoegen

Tijdens het toevoegen van het chipnummer van uw huisdier aan de Microchip Voerbak Connect, moet u ervoor zorgen dat er geen andere huisdieren en ongebruikte penningen in de buurt zijn.

1

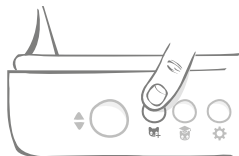

Druk op de knop voor het toevoegen van een huisdier (🐱) achterop de voerbak.

2

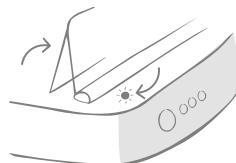

Het deksel gaat open en het led-lampje knippert groen, eenmaal per seconde.

3

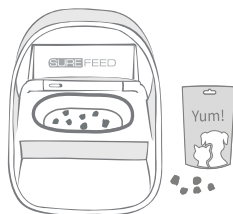

Leg wat voer/snoepjes in de bak en plaats de voerbak waar u uw huisdier normaal gesproken voert.

4



Terwijl uw huisdier eet, scant u het chipnummer. Wanneer het chipnummer is toegevoegd, **stopt het lampje met knipperen** (maar blijft branden).

5

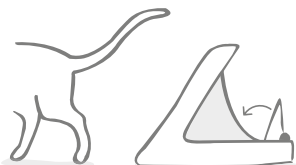

Wanneer uw huisdier wegloopt, sluit het deksel en gaat het led-lampje uit. Het chipnummer van uw huisdier is nu permanent opgeslagen.

i



U kunt zo nodig de modus 'Een huisdier toevoegen' op elk gewenst moment annuleren door nogmaals op de knop voor het toevoegen van een huisdier (🐱) te drukken.



Om het chipnummer van een huisdier te kunnen programmeren, moeten de sensoren in de boog van de voerbak de aanwezigheid van het huisdier detecteren. Daarom is het belangrijk dat uw huisdier zijn kop door de boog steekt om te eten.



Als u een Sure Petcare RFID-penning wilt programmeren, volgt u de bovenstaande stappen, maar houdt u de penning in de boog. Zorg dat u geen metalen sieraden draagt tijdens het programmeren van een penning.



Als u al een huisdier in uw Sure Petcare-huishouden hebt, kunt u dit huisdier aan de voerbak toewijzen. Ga naar het gedeelte Huishouden van de app. Als u per ongeluk het verkeerde huisdier hebt toegevoegd, kunt u dat altijd hier corrigeren.



Porties instellen

De Microchip Voerbak Connect controleert niet alleen wanneer en wat uw huisdier heeft gegeten, maar kan u ook helpen om telkens wanneer uw huisdier eet, nauwkeurige porties te geven.

Waarom zou u het voer van uw huisdier in porties opdelen?

Is uw huisdier misschien wat te zwaar? Door een portiegewicht in te stellen, kunt u ervoor zorgen dat u niet per ongeluk elke dag te veel voer geeft. Alles bij elkaar kan het toch te veel zijn wat u geeft.

Dankzij de mogelijkheid om direct in de voerbak porties te wegen, kunt u er snel en gemakkelijk voor zorgen dat uw huisdier de juiste hoeveelheid eet.

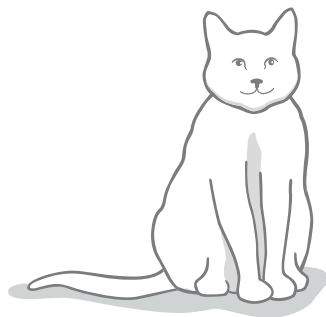

Hoeveel voer heeft uw huisdier nodig?

Het is niet makkelijk om te bepalen welke hoeveelheid juist is voor uw huisdier, vooral omdat er zoveel keuze aan voer is. We raden aan om uw dierenarts of dierenadviseur te raadplegen om te zien wat zij aanbevelen.

U kunt ook de richtlijnen op de verpakking van de producent van de diervoeding volgen. Wat hier staat is vaak een goede richtlijn voor gemiddelde en gezonde huisdieren.

Een portiegewicht instellen in de app

U kunt in de Sure Petcare-app het portiegewicht instellen. Wanneer het gewicht is ingesteld, wordt het naar de voerbak verzonden zodat deze weet hoeveel voer u uw huisdier per portie wilt geven.

De portie-indicatielampjes op de voerbak begeleiden u dan wanneer u voer toevoegt om te zorgen dat uw huisdier de juiste hoeveelheid krijgt. De lampjes geven de hoeveelheid toegevoegde voer aan, **zie pagina 102** voor meer informatie.





Voer toevoegen en vervangen

Het is belangrijk dat u het voer van uw huisdier dagelijks vervangt, niet alleen om uw huisdier tevreden en gezond te houden, maar ook zodat de voerbak schoon blijft en naar behoren werkt.

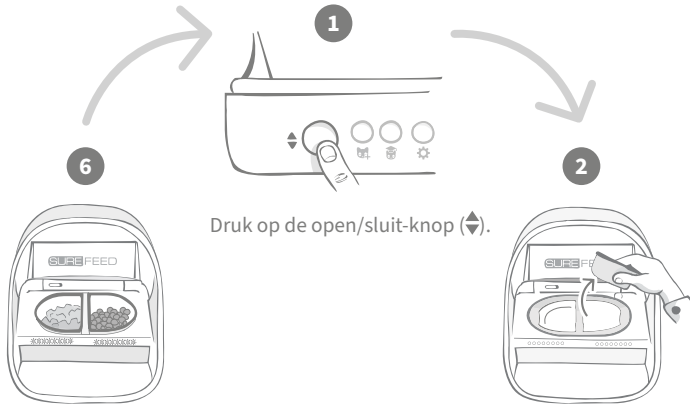

Druk op de open/sluit-knop (↕).

Wanneer alle lampjes groen knipperen, hebt u de bakjes gevuld met een volledige portie.

Verwijder de gebruikte bakjes en eventuele restanten. Was ze af of vervang ze door schone bakjes.

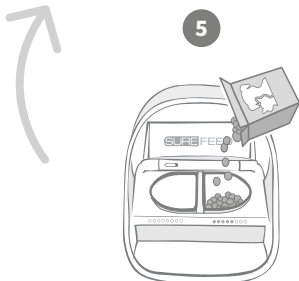

Begin met het vullen van de bakjes nadat u deze op nul hebt gezet. De portie-indicatielampjes gaan branden om de hoeveelheid voer in elke bak aan te geven (zie de volgende pagina).

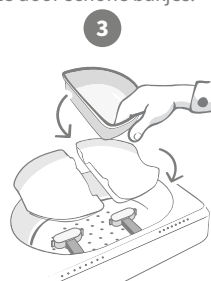

Zorg ervoor dat de houders voor het enkele bakje of de halve bakjes goed op de weegarmen zitten en plaats er een leeg bakje bovenop.

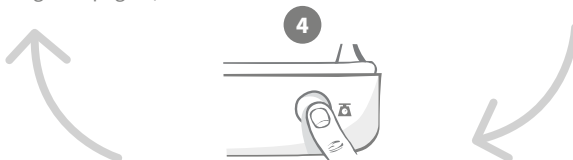

Druk op de nulknop voordat u de bakjes vult, zodat u zeker weet dat u een volledige portie aan uw huisdier geeft. Vergeet niet dat u met deze knop beide zijden van de voerbak op nul zet (zie pagina 97).

Portie-indicatielampjes



Op nul zetten:

Groene lampjes gaan van rechts naar links uit wanneer u op de nulknop drukt.



Voedsel toevoegen:

Als voer wordt toegevoegd, lichten de portie-indicatielampjes groen op en gaan van links naar rechts aan. De lampjes komen overeen met de hoeveelheid voer in de bak. Blijf voer toevoegen tot alle lampjes knipperen.



Het portiegewicht is bereikt:

Wanneer u het gewicht van de portie hebt bereikt (plus of min één gram), gaan de lampjes **groen knipperen**. Als de lampjes niet knipperen, is dit niet een volledige portie.



Te vol:

Als u meer dan het portiegewicht aan het bakje toevoegt, waarschuwen de **rode lampjes** dat het bakje te vol zit. Verwijder gewoon wat voer tot de lampjes groen gaan knipperen.



Houd er rekening mee dat als u in de app geen portiegewicht hebt ingesteld, de portie-indicatielampjes **niet gaan branden** wanneer er voer aan de voerbak wordt toegevoegd.

Zit er nog eten in de bak?

Als het etenstijd is en er is nog wat voer in het bakje, hoeft u niet op de nulknop te drukken. Voeg eenvoudig meer voer toe. De indicatielampjes voor de portiegroten zullen aangeven wanneer de volle portie is bereikt.

1

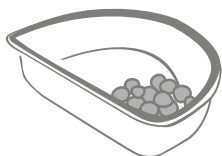

Wanneer u het deksel opent, knipperen sommige lampjes nog even om aan te geven dat de voerbak weet dat er nog voedsel in het bakje zit. Alle lampjes gaan uit zodat u vers voer kunt toevoegen.

2

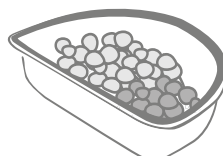

Vul het bakje tot alle portie-indicatielampjes groen knipperen.



Trainingsmodus

(uw huisdier leren de voerbak te gebruiken)



Wanneer in trainingsmode kippert het led-lampje oranje. Wanneer de open/sluit knop wordt gebruikt gaat het lampje rood knipperen. Op deze manier weet u dat er op de open/sluit knop is gedrukt. **Als niet op de open/sluit-knop wordt gedrukt, worden de portie-indicatielampjes niet geactiveerd en kan het systeem niet zien dat u voer toevoegt.**

DEEL 1 - Uw huisdier aan de voerbak laten wennen

Sommige huisdieren hebben mogelijk wat tijd nodig om aan de voerbak te wennen. Met de trainingsmodus kunt u langzaam steeds meer beweging aan het deksel toevoegen. Hierdoor krijgt uw huisdier steeds meer vertrouwen bij het gebruik van de nieuwe voerbak. Het kan even duren, maar wees geduldig en ga pas door naar **DEEL 2** als uw huisdier helemaal gewend is.

1

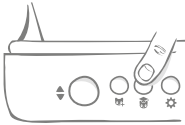

Met het deksel gesloten, drukt u eenmaal op de knop 'Trainingsmodus' (👤) achterop de voerbak. Het deksel gaat open en het led-lampje op de achterkant knippert oranje (om de paar seconden).

2

Vul nu de bak met het favoriete voer van uw huisdier en zet de voerbak op de normale eetplek of ergens waar hij zich prettig voelt.

3



Tijdens deze eerste fase, wanneer u uw huisdier leert de voerbak te gebruiken, **sluit het deksel niet** nadat hij klaar is met eten.



Neem de tijd en laat uw huisdier wennen aan zijn nieuwe voerbak. Als uw huisdier zich op zijn gemak voelt, gaat u door naar DEEL 2.

DEEL 2 - De beweging van het deksel vergroten

Door de beweging van het deksel langzaam te vergroten, kan uw huisdier er in drie fasen aan wennen. Voor de beste resultaten en een tevreden huisdier, is het wederom belangrijk dat u geduldig bent en dit proces niet te snel doorloopt. Hoelang elke fase duurt, verschilt per huisdier (dagen/weeken) maar het is raadzaam een paar dagen over elke fase te doen.

4



Vergroot de beweging van het deksel door nogmaals op de knop 'Trainingsmodus' (👤) te drukken. Het deksel sluit een beetje en het lampje op de achterkant knippert tweemaal oranje.

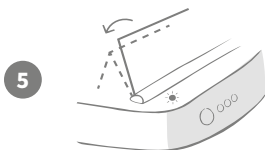

5

Als uw huisdier nu uit de bak eet, is er wat beweging wanneer het deksel helemaal opengaat. Wanneer hij klaar is met eten, gaat het een beetje dicht.



6

Geef uw huisdier voldoende tijd om aan de nieuwe beweging van het deksel te wennen. Als u het voer moet vervangen, doet u dit op de gebruikelijke manier (zie pagina 101). Nadat u het voer hebt vervangen, moet u op de open-/sluitknop drukken (↕) om het deksel te sluiten naar de trainingsstand.



Neem de tijd. Ga pas door naar de volgende fase als uw huisdier zich op zijn gemak voelt bij deze beweging van het deksel.

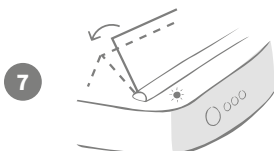

7

Als uw huisdier zich op zijn gemak voelt, drukt u nogmaals op de knop 'Trainingsmodus' (🐾). Het deksel gaat dicht tot de volgende stand en het lampje op de achterkant knippert nu driemaal oranje.



Gebruik de voerbak weer zoals gewoonlijk en ga pas door naar de volgende fase als uw huisdier zich op zijn gemak voelt bij deze beweging.

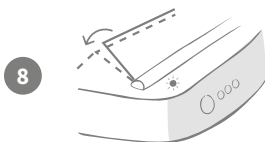

8

Uw huisdier zou zich nu op zijn gemak moeten voelen, dus in deze laatste trainingsfase gaat het deksel nog verder dicht. Druk net als voorheen weer op de knop 'Trainingsmodus' (🐾). Het deksel gaat dicht tot de laatste stand en het lampje op de achterkant knippert nu viermaal oranje.



9

Als uw huisdier zich op zijn gemak voelt bij deze laatste stand, drukt u nogmaals op (🐾). Het deksel sluit volledig en het lampje op de achterkant knippert niet meer. De voerbak is nu afgesloten en bevindt zich in de modus voor dagelijks gebruik.



U kunt de trainingsmodus op elk moment beëindigen door de knop 'Trainingsmodus' (🐾) **5 seconden** ingedrukt te houden.



Als u een stap terug moet gaan, volgt u bovenstaande tip op. Hierdoor wordt de voerbak uit de trainingsmodus gehaald en kunt u het proces weer van voren af aan uitvoeren.



Als uw huisdier naar achteren stapt en wat angstig lijkt terwijl het deksel sluit, kunt u in de Sure Petcare-app aanpassen hoe snel het deksel sluit.



Reiniging en onderhoud

Het is belangrijk dat u de Microchip Voerbak Connect schoonhoudt zodat deze goed blijft werken. **Dompel de voerbak NIET onder in water en zet hem niet onder een lopende kraan. Water kan de voerbak en elektronica van de voerbak beschadigen.**

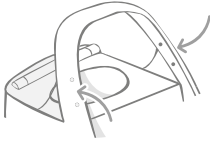
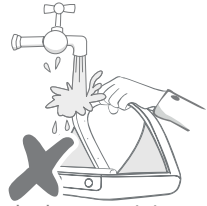

Houd de vier zwarte punten op de boog altijd goed schoon om juiste werking te garanderen.

U kunt de mat schoonvegen met een vochtige doek.

Zet de onderdelen niet in de vaatwasser. Was ze alleen met de hand af.

De Microchip Voerbak Connect heeft een **deksel voor reinigingsdoeleinden** op de onderkant om het verwijderen van voedselrestanten en vuil te vergemakkelijken.

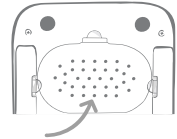

Het deksel verwijderen om het schoon te maken

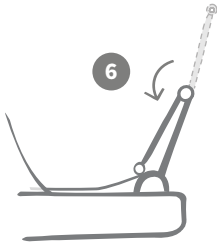

Klap nu de bovenste helft van het deksel naar achteren zodat het op de dekselgeleiders rust.

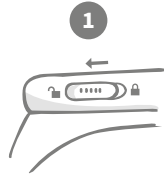

Schuif de vergrendelingsknop naar de ontgrendelde positie.

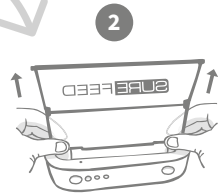

Druk op de knop (↕). Zodra het deksel open is, trekt u het omhoog.

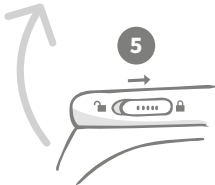

Schuif de vergrendelingsknop terug naar de vergrendelde positie.



Na het schoonmaken plaatst u het deksel terug terwijl u beide helften in verticale stand houdt. Zorg dat het goed is bevestigd.



Alleen met de hand afwassen. Niet in de vaatwasser afwassen.

Hoe u de voerbak schoon kunt houden

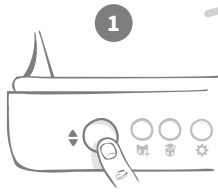

1 Druk op de open/sluit-knop (◊).

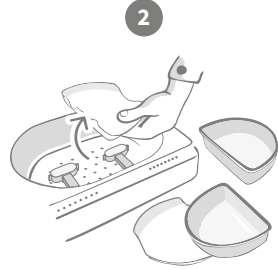

2 Verwijder de bakjes, bakhouders en het deksel (zie vorige pagina).



7 Bevestig alle onderdelen weer en zorg dat de **klep voor reinigingsdoeleinden eerst** wordt bevestigd.

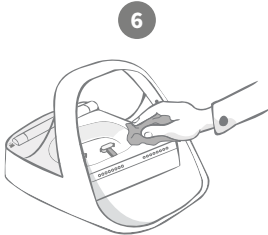

6 Gebruik een vochtige doek om te zorgen dat alle oppervlakken van de voerbak schoon zijn. **Gebruik geen schurende schoonmaakmiddelen.**

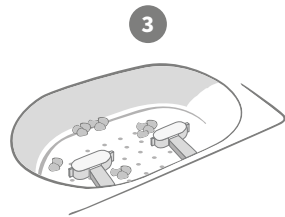

3 Vuil dat zich rond de weegarmen bevindt, kan de werking van de voerbak beïnvloeden. Het is dus erg belangrijk om dit gebied schoon te houden. **Gebruik geen schuursponjes.** Deze kunnen de voerbak beschadigen waardoor hij niet meer goed werkt.

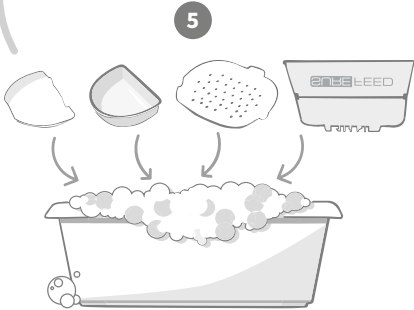

5 **Was alle verwijderbare delen met de hand af.** Plaats ze niet in de vaatwasser.

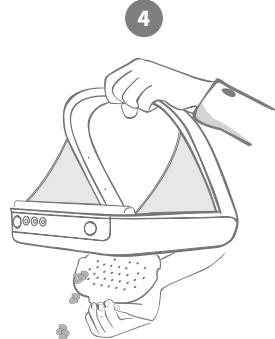

4 Houd de voerbak boven de vuilnisbak, verwijder de reinigingsklep en laat het vuil eruit vallen.



Help en ondersteuning

Aangepaste instellingen

We begrijpen dat niet alle huisdieren hetzelfde gedrag vertonen en hebben daar rekening mee gehouden bij het ontwerpen van de Microchip Voerbak Connect. De voerbak bevat verschillende aangepaste instellingen waarmee u de voerbak kunt aanpassen als uw huisdieren deze op onverwachte of ongebruikelijke manieren gebruiken. Hieronder vindt u enkele voorbeelden van dierengedrag dat u met de aangepaste instellingen kunt oplossen:

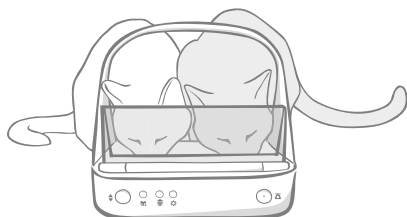

Eet uw niet-geregistreerde huisdier mee met uw geregistreerde huisdier?

Daar hebben we een aangepaste instelling voor.

Steelt uw niet-geregistreerde huisdier voer uit de voerbak van een ander huisdier terwijl de bak zich in trainingsmodus bevindt?

Daar hebben we een aangepaste instelling voor.

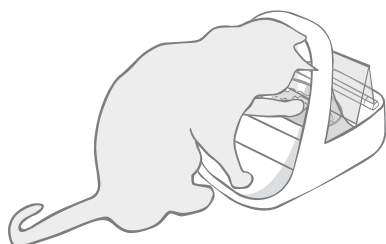

Heeft uw slimme, niet-geregistreerde huisdier ontdekt hoe hij kan voorkomen dat het deksel dichtgaat?

Daar hebben we een aangepaste instelling voor.

Probeert uw niet-geregistreerde huisdier voer uit de achterkant van de voerbak te stelen?

Daar hebben we een accessoire voor.

Ga naar [surepetcare.com/accessoires](https://www.surepetcare.com/accessoires) en zoek naar Achterklep.

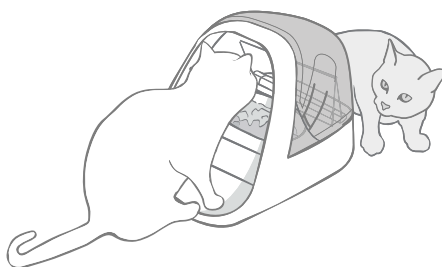

Neem contact op met ons klantenserviceteam om aangepaste instellingen te bespreken (**kijk op de achterzijde voor details**). Zij kunnen de meest geschikte aangepaste instelling voor uw situatie bepalen en deze op afstand instellen.

De hub

Rood knipperende oren

De verbinding van de hub met de Microchip Voerbak Connect is verbroken.

- Als **beide oren van de hub tijdens het instellen rood knipperen**, herstelt u de fabrieksinstellingen door de knop aan de onderkant van de hub 10 seconden ingedrukt te houden.
- Als **beide oren na het instellen langere tijd rood knipperen**, schakelt u de hub uit en weer in. Schakel de stroomtoevoer uit bij het stopcontact, wacht 30 seconden en schakel deze dan weer in. Als de oren enkele minuten groen blijven branden, heeft de hub opnieuw verbinding gemaakt.
- U kunt ook **de hub verplaatsen**. Volg hierbij het advies op **pagina 93**. Als dat niet werkt, moet u de hub dichterbij de voerbak plaatsen, zoals hieronder beschreven.
- Als u de hub dichterbij wilt plaatsen, kunt u hem op de router aansluiten met een langere ethernet-kabel.
- Als het bovenstaande niet werkt, raden we aan een **ethernet-over-power-adapter** aan te schaffen. U kunt deze adapter in een normaal stopcontact steken en zo uw hub dichterbij de voerbak met internet verbinden.

Afwisselend knipperende oren (rood of groen)

De hub kan geen verbinding maken met de Sure Petcare-servers. Dit kan komen door een instabiele internetverbinding.

- Zet de hub uit en weer aan door de stroomtoevoer bij het stopcontact uit te schakelen, 30 seconden te wachten en deze dan weer in te schakelen. Als de oren enkele minuten groen blijven branden, heeft de hub opnieuw verbinding gemaakt.
- Als de bovenstaande oplossing niet werkt, controleert u of uw internetrouter is ingeschakeld en of uw internetverbinding goed werkt met andere apparaten.
- Als de internetverbinding ook niet werkt op andere apparaten, zet u de router uit, wacht u 30 seconden en zet u hem weer aan.
- Als de router wel met andere apparaten werkt, sluit u de ethernet-kabel opnieuw aan op de router en de hub. Zorg dat de kabel goed in de aansluiting zit. Soms lijkt de kabel goed aangesloten te zijn terwijl dat niet zo is.

Als u verbindingproblemen blijft ondervinden, gaat u naar:

surepetcare.com/hub-connectivity.

Oren branden rood

Uw hub voert een firmware-update uit. Wacht tot de oren van de hub groen worden.

Dit duurt meestal niet langer dan 2 minuten. Wanneer de firmware-update is voltooid, moet de hub opnieuw worden gestart. Op dat moment ziet u de instellingslampjes oplichten (**zie pagina 94**).

Trage meldingen

Als berichten soms traag in uw app verschijnen, komt dit waarschijnlijk doordat uw hub hard moet werken om verbinding te maken met de Microchip Voerbak Connect. Probeer uw hub naar een betere locatie te verplaatsen om de snelheid van berichten te verbeteren. Volg hiervoor het advies op **pagina 93**.

Microchip Voerbak Connect

Als er mechanische problemen zijn met de voerbak, probeer deze dan niet zelf te repareren. Neem in plaats daarvan contact op met ons behulpzame klantenserviceteam (zie **achterblad** voor contactgegevens).

De voerbak gaat niet open voor mijn huisdier.

- Zorg dat de vier sensoren in de boog schoon zijn (**zie pagina 105**).
- Controleer of u **alkalinebatterijen** van goede kwaliteit hebt gebruikt en deze niet bijna leeg zijn. Zorg ervoor dat de + en - van de batterijen in de juiste richting zijn geplaatst (**zie pagina 95**).
- Plaats de voerbak uit de buurt van metalen of elektrische apparatuur. Als de voerbak nog steeds niet opengaat voor uw geregistreerde huisdier, leest u verder.
- Controleer of er geen overduidelijke storingsbronnen in de buurt zijn, zoals lampen die knipperen terwijl dit niet zou moeten. Neem contact op met onze klantenservice als u denkt dat dit het geval is. **Kijk op de achterzijde voor details.**
- Als dit niet werkt, laat dan uw dierenarts controleren of de chip van uw huisdier werkt en of deze zich op de gebruikelijke plek bevindt. Als de chip op een geheel andere plek is gaan zitten, is hij moeilijk te lezen. In de tussentijd kunt u de meegeleverde Sure Petcare RFID-penning gebruiken. Bevestig de penning aan de halsband van uw huisdier en herhaal het proces voor het toevoegen van uw huisdier (**zie pagina 99**).

Mijn huisdier wil de voerbak niet gebruiken

- Herhaal het trainingsproces, waarbij u uw huisdier tussen elke stap meer tijd gunt om te wennen. **Zie pagina 103-104.**
- Als uw huisdier nog steeds behoedzaam is bij gebruik van de voerbak, volgt u de stappen op **surepetcare.com/cautiouspet** Probeer nooit uw huisdier te dwingen om ui de voerbak te eten.
- Evalueer de eetomgeving van uw huisdieren. Benaderen ze hun bakje altijd vanaf een bepaalde kant? Hebben ze liever niet hun rug naar de deur? Er is geen vaste richting waarin de voerbak moet worden geplaatst, dus aarzel niet om hem anders neer te zetten als uw huisdier dat prettiger vindt.

Als de vertraging waarmee het deksel sluit nadat uw huisdier klaar is met eten niet bij hem past, kunt u het sluiten van het deksel versnellen of vertragen in de Sure Petcare-app.

Het deksel gaat niet helemaal dicht

- Dit kan komen door etensresten die onder het deksel of in het mechanisme terecht zijn gekomen. Voor een goede sluiting van het deksel is het belangrijk dat u etensresten van de oppervlakken van de voerbak veegt (**zie pagina 105-106**).
- Zorg ervoor dat u niet meer in de trainingsmodus bevindt, ga naar **pagina 103** voor meer informatie over het gedrag van de trainingsmodus.

De portie-indicatielampjes branden, maar de bak is leeg

Als bij het openen van de voerbak een deel van de indicatielampjes groen oplicht, terwijl er geen voer meer in de bakjes zit, geeft dit aan dat de bakjes op nul moeten worden gezet. U kunt dit voorkomen door altijd op de nulknop te drukken voordat u het voer vervangt, **zie pagina 101-102.**

De portie-indicatielampjes reageren niet

- Houd er rekening mee dat als u in de Sure Petcare-app geen portiegewicht hebt ingesteld, de portie-indicatielampjes niet gaan branden wanneer er voer wordt toegevoegd.
- Bovendien kan vuil dat zich rond de weegarmen bevindt, de werking van de voerbak beïnvloeden. Het is dus erg belangrijk om om dit gebied schoon te houden (**zie pagina 105-106**).

Andere huisdieren stelen voer

- Als andere huisdieren voer proberen te stelen uit een geopende voerbak, kunt u het sluiten van het deksel nadat het huisdier heeft gegeten, versnellen via de Sure Petcare-app.
- Het is mogelijk dat er een aangepaste instelling is waarmee u uw specifieke probleem kunt oplossen. Neem contact op met ons klantenserviceteam uw specifieke situatie te bespreken (**kijk op de achterzijde voor contactgegevens**).
- Als huisdieren erin slagen om voer te stelen via de achterkant of zijkant van de voerbak (terwijl het deksel openstaat en een geregistreerd huisdier aan het eten is), dan is hiervoor een achterklep beschikbaar die dergelijk slim en vastberaden gedrag kan stoppen. Ga voor meer informatie naar **surepetcare.com/accessoires**

De batterijen raken te snel leeg

- Zorg ervoor dat de voerbak schoon is en dat de sensoren schoon zijn (**zie pagina 105**).
- Zorg dat u batterijen gebruikt van goede kwaliteit en dat ze goed in het vak zijn geplaatst (**zie pagina 95**).
- Controleer of er geen overduidelijke storingsbronnen in de buurt zijn (zoals lampen die knipperen terwijl dit niet zou moeten, enzovoort). Neem contact op met onze klantenservice als u denkt dat dit het geval is. Zie de **achterzijde** voor details.

Meerdere voerbakken in één huishouden

- Als u merkt dat uw huisdieren in de war zijn over welke voerbak ze moeten gebruiken, kunt u bakjes in verschillende kleuren en aparte eetplekken gebruiken. Dit kan helpen. Bakjes en matjes in verschillende kleuren worden apart verkocht. Ga voor meer informatie naar **surepetcare.com/accessoires**

Hebt u meer hulp nodig?

- Als u verbindingproblemen blijft ondervinden, gaat u naar: **surepetcare.com/hub-connectivity**
- Voor meer begeleiding, video's en klantenforums gaat u naar: **surepetcare.com/ondersteuning**
- Als u problemen ondervindt met uw Sure Petcare-app, gaat u naar: **surepetcare.com/apphelp**



Of neem contact op met ons behulpzame klantenserviceteam. **Zie achterkant voor contactgegevens.**



Garantie en disclaimer

Garantie: Voor de SureFeed Microchip Voerbak Connect voerbak geldt een garantie van 3 jaar vanaf de aankoopdatum (aankoopbewijs vereist). De garantie dekt alleen fouten veroorzaakt door defecte materialen, onderdelen of fabricage. Deze garantie dekt geen defecten die zijn veroorzaakt door normale slijtage, misbruik, verwaarlozing of opzettelijke beschadiging. In het geval van gebreken als gevolg van defecte onderdelen of fabricagefouten worden de desbetreffende onderdelen tijdens de garantieperiode gratis vervangen. Bij ernstigere defecten kan de fabrikant naar eigen goeddunken gratis een vervangend product verschaffen. Dit doet geen afbreuk aan uw wettelijke rechten.

Disclaimer: De Microchip Voerbak Connect en app rapporteren de voedselconsumptie van huisdieren door het chipnummer van een huisdier te detecteren en vervolgens het gewicht van een bakje te meten voor en na het eten. In de meeste gevallen geeft dit betrouwbare informatie over de voedselconsumptie van uw huisdieren, maar onverwacht of ongewoon gebruik van de voerbak (als uw huisdier bijvoorbeeld een bakje verwijdert of met het voer speelt) kan leiden tot onbetrouwbare informatie. Sure Petcare aanvaardt geen aansprakelijkheid voor schade, letsel of overlast voortvloeiend uit onjuiste rapportage van de voedselconsumptie van uw huisdier.

De SureFeed Microchip Voerbak Connect is uitgerust met functies voor selectieve toegang, waardoor het risico dat huisdieren elkaars voer opeten, tot een minimum wordt beperkt. Het is echter niet mogelijk volledig te garanderen dat alle andere huisdieren onder alle omstandigheden zullen worden uitgesloten. In de zeldzame gevallen dat een niet-geregistreerd huisdier toegang tot de voerbak weet te krijgen, aanvaardt Sure Petcare geen aansprakelijkheid voor hieruit voortvloeiende schade of overlast.



Producten en gebruikte batterijen wegwerpen: Dit pictogram geeft producten aan die onderhevig zijn aan de volgende wetgeving:

De richtlijn Afdankte elektrische en elektronische apparatuur 2012/19/EU (AEEA-richtlijn) en de Batterijrichtlijn 2006/66/EC en Amendement 2013/56/EU verplicht huishoudens om lege batterijen en afgedankte producten zo milieuvriendelijk mogelijk weg te werpen, aangezien hiermee het effect van het afval op het milieu tot een minimum wordt beperkt. Daarom kunnen batterijen en afgedankte producten niet bij het huishoudelijke afval worden afgevoerd, maar moeten ze bij een geschikte recyclinginstantie worden gerecycled.

Zorg dat u de batterijen vervangt vóór de houdbaarheidsdatum op de verpakking of op de batterijen zelf, en gooi ze op een veilige en correcte manier weg.

Draag bij lekkende batterijen geschikte beschermende kleding om uzelf te beschermen tegen blootstelling aan schadelijke chemische stoffen voordat u de batterijen weggooit en gelekte vloeistoffen opruimt. Vermijd contact met de huid bij het schoonmaken van gemorste chemische stoffen. Houd chemische stoffen van batterijen uit de buurt van de ogen en voorkom dat ze worden ingeslikt. Neem onmiddellijk contact op met een arts als chemische stoffen in de ogen zijn gekomen of zijn doorgeslikt.

Handelsmerken: Google Play en het Google Play-logo zijn handelsmerken van Google Inc.

Apple is een handelsmerk van Apple Inc., gedeponeerd in de VS en andere landen. Apple Store is een servicemerk van Apple Inc., gedeponeerd in de VS en andere landen. IOS is een handelsmerk of gedeponeerd handelsmerk van Cisco in de VS en andere landen, en wordt onder licentie gebruikt.



SURE[™]
PETCARE

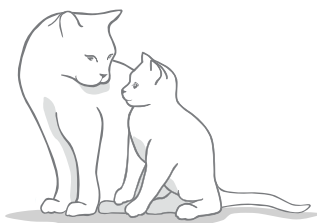

Comedero para mascotas con microchip Connect

¡Gracias por elegir el comedero para mascotas con microchip Connect!

El comedero para mascotas con microchip Connect consta de tres elementos que le permiten un mejor seguimiento de su mascota y una mejor comprensión de sus hábitos alimenticios.

El **comedero para mascotas con microchip Connect** es el componente principal del sistema. Reconoce el microchip de identificación ya implantado en su mascota o la placa de identificación mediante radiofrecuencia Sure Petcare (una incluida), para permitir que su mascota acceda a la comida mientras mantiene alejados a otros animales.

El **Concentrador** (a la venta por separado) es el elemento conectado del sistema. Se conecta a la red de Internet de la casa y puede comunicarse tanto con el comedero como con la aplicación Sure Petcare.

Mediante la **aplicación Sure Petcare**, podrá controlar cuánta comida consume su mascota y la frecuencia con la que visita el comedero. La aplicación también le permite enviar una porción de peso al comedero, para ajustar la cantidad de comida por ración.

Contenido de la caja

Asegúrese de que ha recibido todos estos componentes*

- 1 1 comedero para mascotas con microchip Connect
- 2 1 plato estándar
- 3 2 medios platos
- 4 1 alfombrilla
- 5 1 soporte de plato estándar
- 6 2 soportes de medios platos
- 7 1 placa de identificación mediante radiofrecuencia Sure Petcare

*Las pilas y el Concentrador no están incluidos

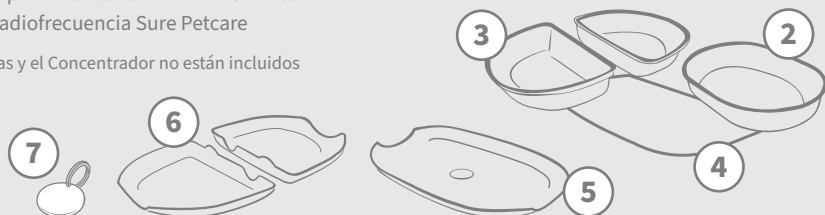
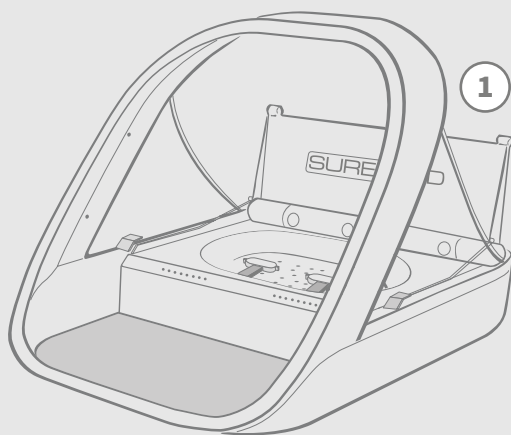

Para que su comedero para mascotas con microchip Connect funcione como un sistema conectado, debe comprar un Concentrador. Para obtener información sobre la adquisición de un Concentrador, visite surepetcare.com/hub.

Contenido

Información importante	116
Descripción del producto.....	118
Comedero para mascotas con microchip Connect.....	120
Concentrador	
Configurar el Concentrador	121
Dónde colocar el Concentrador.....	122
Luces del Concentrador	123
Comedero	
Pilas	124
Conectar el comedero.....	125
Botones y luces	126
Agregar su mascota al comedero	128
Configurar porciones	129
Agregar y cambiar comida	130
Modo de entrenamiento	132
Limpieza y mantenimiento	134
Ayuda y soporte.....	136
Garantía/Renuncia de responsabilidad	140



Información importante



LEA DETENIDAMENTE LA SIGUIENTE INFORMACIÓN Y GUARDE ESTE MANUAL PARA CONSULTAS POSTERIORES.



Este producto es **solo para mascotas domésticas.**



Utilice únicamente accesorios SureFeed para garantizar la compatibilidad: surepetcare.com/accessories



Asegúrese de tener todos los componentes enumeradas en la **página 113.**



No coloque el comedero en lugares de paso frecuente.



El comedero está diseñado **únicamente para su uso en interiores.**



No sumerja el comedero en agua, ni lo ponga bajo el grifo.



No meta el comedero en la nevera ni coloque hielo debajo ni en su interior.



No coloque el comedero en sitios expuestos a un calor excesivo.



Este producto requiere **4 pilas tipo C**, que deben colocarse y sustituirse con precaución. No mezcle diferentes tipos de pilas ni use una combinación de pilas nuevas y usadas. Si el comedero se va a almacenar sin usar durante un período prolongado, quite las pilas.

El **código de producto** y el **número de serie** del Comedero para mascotas con microchip figuran en la base del producto.

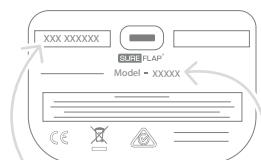

Número de serie

Código de producto

Advertencias de seguridad

- **No** utilice este producto si faltan componentes o alguno de los existentes está dañado o desgastado.
- **Este artículo incluye piezas pequeñas.** Las piezas sueltas deben mantenerse fuera del alcance de los niños y las mascotas para **evitar riesgos de asfixia.**

Otras consideraciones importantes



MASCOTAS: Sure Petcare recomienda que el comedero para mascotas con microchip SureFeed Connect se use con el microchip que su mascota ya tiene implantado. No obstante, también se puede utilizar con la placa de identificación mediante radiofrecuencia Sure Petcare. Si se utiliza la placa, debe colocarse en un collar de seguridad **que tenga una hebilla desmontable** (solo aplicable a gatos). Sure Petcare no puede aceptar ninguna responsabilidad por lesiones o muertes causadas por collares de mascotas.



ACCESO A LA COMIDA: Sure Petcare no se hace responsable del acceso no autorizado de ninguna mascota debido a un uso fuera de lo previsto. Como propietario de este producto, **usted acepta toda la responsabilidad de supervisar la administración de cualquier alimento** que pueda ser perjudicial para otros animales domésticos si se consume inadvertidamente.



SIN TEMPORIZADOR: Este producto no contiene un temporizador ni **funciones de control de tiempo**. Por lo tanto, no deje a su mascota sola, ni confíe en este producto para alimentarla durante periodos prolongados (no más de 24 horas para un gato, o la cantidad promedio de tiempo entre comidas para un perro pequeño). **Este producto no sustituye su responsabilidad hacia el animal.**



NIÑOS: No se debería permitir que los niños jueguen con el comedero para mascotas con microchip SureFeed Connect. No es un juguete y no debe ser tratado como tal. No obstante, este producto puede ser usado por niños mayores de 8 años y también por personas con discapacidades físicas, sensoriales o mentales, siempre y cuando se les supervise o hayan recibido instrucciones sobre el uso del producto de manera segura. Deben estar debidamente informados sobre cualquier peligro potencial relacionado. No permita que los niños (de cualquier edad) limpien el producto sin supervisión.



SEGURIDAD INFANTIL: En hogares donde hay niños, es esencial **tener en cuenta el comedero para mascotas con microchip SureFeed Connect al tomar medidas de seguridad**. El uso indebido de este producto por parte de un niño podría exponerlo a posibles peligros. Por este motivo, se debe supervisar en todo momento a los niños cuando se encuentren en las proximidades del comedero. Tenga en cuenta también que cuando el comedero está en **modo de entrenamiento (véase la página 131-132) la comida de las mascotas es accesible para los niños.**



Descripción del producto

El comedero para mascotas con microchip Connect consta de tres componentes principales:

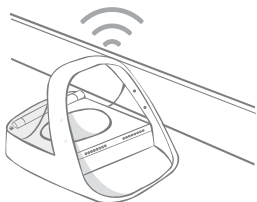

Comedero para mascotas con microchip Connect



Concentrador



Aplicación Sure PetCare

El Concentrador se conecta a Internet a través de un cable Ethernet y supervisa la actividad del comedero para mascotas con microchip Connect. Se comunica tanto con el comedero como con la aplicación Sure Petcare, así podrá ver qué ocurre en su casa incluso cuando está lejos de ella.

También puede configurar el peso de una porción en la aplicación. Después de eso, el comedero le guiará cuando agregue comida, para garantizar que su mascota reciba la cantidad correcta.

Para obtener más información, **véase la página 126.**

Platos y soportes de platos:

véase la página 118.

Sensores: Cuatro puntos en el interior del aro. Sirven para detectar a la mascota.

Alfombrilla: Pensada para facilitar la limpieza de comida esparcida.

Luces indicadoras de porción: véase la página 126.

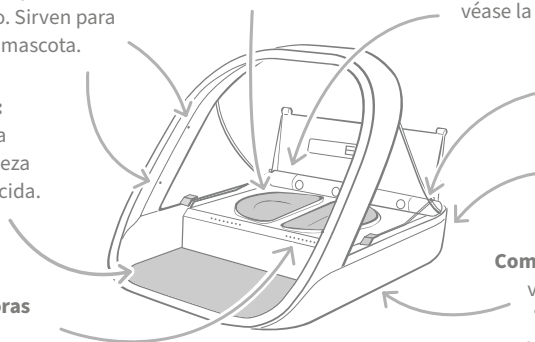

Bloqueo de la tapa:

véase la página 125.

LED posterior: véase la página 126.

Botones: véase la página 125.

Compartimentos de pilas:

véase la página 123.

Tapa de limpieza: véase la página 133.

Luces del Concentrador: véase la página 122.

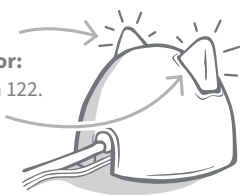

Puerto Ethernet: para conectar el enrutador de Internet.

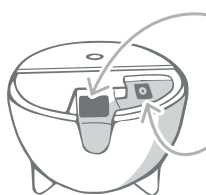

Fuente de alimentación: para conectar el cable de alimentación.

Los platos SureFeed tienen un sistema de sellado en el borde superior para mantener la comida fresca durante más tiempo. Si la mascota solo come un tipo de alimento, puede usar el plato estándar, pero si toma comida seca y húmeda, lo mejor es usar medios platos.



Plato estándar -

Tiene una capacidad de 250 g, suficiente para al menos 2 bolsitas de comida húmeda.

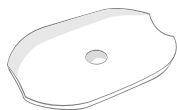

Soporte de plato estándar -

Diseñado para el plato estándar (no los medios platos).

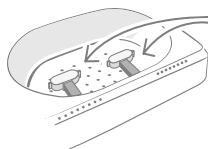

Brazos de pesaje -

Sostienen el soporte del plato.



Medios platos -

Cada medio plato tiene una capacidad de 100 g.



Soportes de medios platos -

Cada uno de esos idóneo para medio plato (no para el plato estándar).

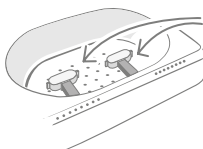

Brazos de pesaje -

Sostienen los soportes de los platos.



No ponga la comida directamente sobre los soportes. Utilice siempre los platos para garantizar el correcto funcionamiento del comedero.

El plato con partición SureFeed no está diseñado para el comedero para mascotas con microchip Connect.

Para comprar platos o alfombrillas adicionales, consulte a su distribuidor de Sure Petcare o visite surepetcare.com.

Ponga una nota de color



Las alfombrillas y los platos de plástico SureFeed están disponibles en cuatro colores: azul, verde, rosa y gris.

O un toque destellante

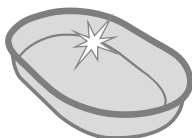

El plato estándar SureFeed también está disponible en acero inoxidable.



No meta los platos en el lavavajillas ni en microondas.



Lave a mano los platos antes del primer uso.



Comedero para mascotas con microchip Connect

Descargue la aplicación gratuita Sure Petcare

CONSIGUELO EN EL
APP STORE

DISPONIBLE EN
GOOGLE PLAY

 surepetcare.io



Reciba notificaciones cuando su mascota coma del comedero.



Supervise el consumo de alimento de su mascota y fíjese en sus cambios de comportamiento.



Dosifique la comida con precisión para controlar la cantidad de cada ración.



Comparta con familiares y amigos el acceso a su casa.



Descargue la **aplicación Sure Petcare** y cree una cuenta. Se le pedirá que cree una “casa” (una red conectada que contenga todos sus productos y mascotas conectados con Sure Petcare). Puede invitar a otros miembros de su familia a unirse a su casa.

Para descargar la aplicación, deberá tener instalada en su móvil o tablet la versión **iOS 9** para **Apple** o la **4.4** en **Android**.



Si prefiere controlar sus productos conectados a Sure Petcare desde un ordenador, puede usar la aplicación web Sure Petcare, disponible en **surepetcare.io**.

Necesitará la versión más reciente de **Safari**, **Chrome**, **Firefox** o **Internet Explorer** en **Mac OS X v10.9** (o posteriores) o **Windows 7** (o posteriores).

Compre un Concentrador Sure Petcare



Para que el comedero para mascotas con microchip Connect funcione con la aplicación Sure Petcare, se necesita un Concentrador. Para obtener más información, visite surepetcare.com/hub.



Configurar el Concentrador

Después de descargar la aplicación Sure Petcare, deberá conectar el Concentrador y configurarlo. Después de hacerlo, se le indicará que lo conecte al comedero y también a la aplicación. Siga los pasos a continuación:

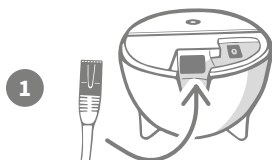

Conecte un extremo del cable Ethernet a la base del Concentrador y el otro extremo a un puerto Ethernet libre en el enrutador.



Ensamble la fuente de alimentación y conéctela a la toma de corriente. Conecte el otro extremo del cable a la base del Concentrador.

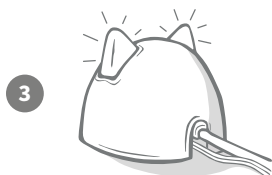

El color de las “orejas” del Concentrador empezará a **alternar entre rojo y verde**. Cuando ambas orejas permanezcan verdes, es señal de que el Concentrador está listo. Si las orejas no completan esa secuencia, **consulte la página 122** para obtener más información.



Para completar la configuración del comedero para mascotas con microchip Connect, **siga los pasos restantes en la aplicación Sure Petcare**.



Podría recibir actualizaciones de software para el Concentrador. Si ve **alguna luz roja permanente** durante la instalación, no se alarme: indica que se está actualizando el software. Al completarse la actualización, el Concentrador se reiniciará y verá la secuencia luminosa detallada en el paso 3.



Dónde colocar el Concentrador

Debido a que el comedero para mascotas con microchip Connect se comunica de forma inalámbrica, la ubicación del Concentrador puede afectar al funcionamiento.



Coloque el Concentrador al menos a 1 metro del suelo (por ejemplo, sobre una mesa, que debe estar lo más despejada posible).

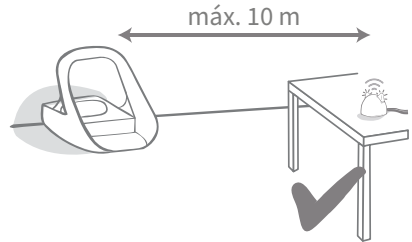

Intente colocar el Concentrador de modo que quede en una línea de visión directa con el comedero, en un radio máximo de 10 metros.

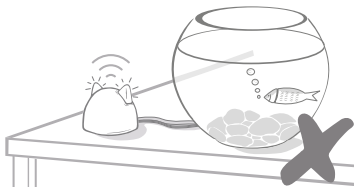

Evite colocar el Concentrador cerca o en la línea de visión de grandes cantidades de agua (por ejemplo, peceras).

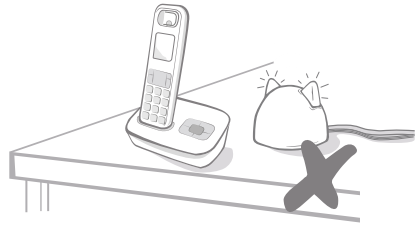

Mantenga el Concentrador lo más alejado posible de cualquier fuente potencial de interferencias (por ejemplo, teléfonos inalámbricos digitales, monitores para bebés, etc.).

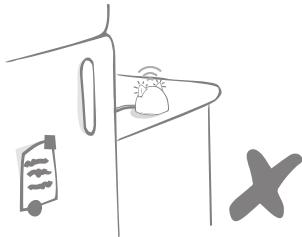

Asegúrese de que el Concentrador no esté junto a objetos metálicos grandes (por ejemplo, frigoríficos).

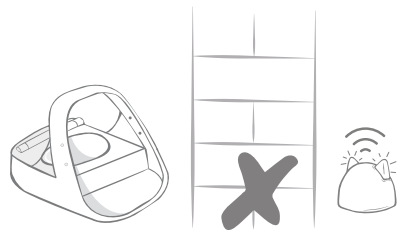

No debería haber paredes gruesas entre el Concentrador y el Comedero.



Ocasionalmente, el Concentrador puede tener problemas de conexión aunque se sigan estos consejos. Para obtener más consejos sobre cómo acercar el Concentrador al comedero para mascotas con microchip Connect, vaya a surepetcare.com/hub-connectivity.



Si el Concentrador pierde la conexión a Internet por algún motivo, el comedero para mascotas con microchip Connect seguirá funcionando normalmente y conservará su configuración.



Luces del Concentrador

El estado actual del Concentrador se indica mediante las luces de las orejas. Las distintas secuencias de luces de colores significan cosas diferentes.

Luces de configuración

Cada vez que el Concentrador se enciende o intenta conectarse a otros componentes del sistema, verá las luces de configuración:

- 1 las orejas se iluminarán **en rojo** alternando de una a otra,



- 2 luego **alternarán en verde**,



- 3 cuando vea un **destello naranja** y las orejas **queden iluminadas en verde**, el Concentrador está conectado.



Orejas verdes

Las orejas verdes indican que el Concentrador funciona correctamente. A continuación se detalla el significado de cada secuencia luminosa.

Ambas orejas verdes – El Concentrador está encendido, conectado y funciona correctamente.

Orejas verdes alternantes – El Concentrador se está reconectando a nuestros servidores.

Orejas rojas

Ambas orejas rojas – El Concentrador está instalando una actualización de software. Tenga paciencia, el Concentrador no tardará en reiniciarse y reanudar su funcionamiento normal.

Ambas orejas rojas intermitentes – El Concentrador ha perdido la conexión con el comedero y está intentando reconectarse.

Orejas rojas alternantes – El Concentrador tiene dificultades para conectarse a Internet y/o los servidores.

- i** Para obtener más información sobre el diagnóstico de estos problemas, consulte la **página 136**.



Pilas

Use siempre **4 pilas alcalinas de tamaño C de 1,5 voltios, que sean de buena calidad.** Así se asegura el funcionamiento óptimo del comedero para mascotas con microchip Connect. **Este producto no está diseñado para usar pilas recargables.** Para insertar o cambiar las pilas, siga los pasos a continuación:

i Hay una luz cerca de la parte posterior del comedero. Si las pilas tienen poca carga o no están bien colocadas, esta luz emitirá un destello rojo cada 5 segundos.

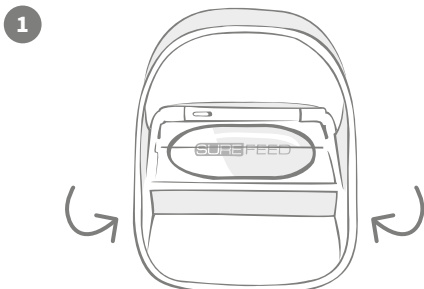

Dele la vuelta al comedero para acceder al compartimento de las pilas.

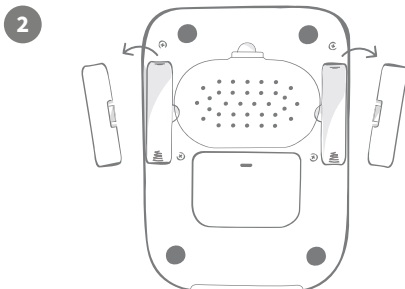

Levante las tapas de las pilas.

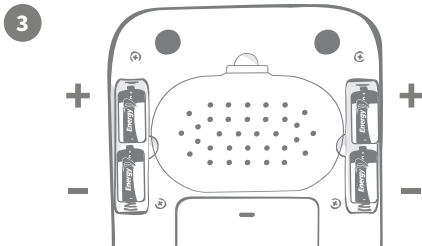

Coloque las pilas. Asegúrese de que los símbolos +/- de las pilas coincidan con los símbolos en el comedero.

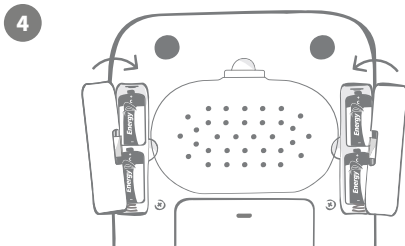

Vuelva a colocar las tapas de las pilas.



Después de programar el microchip de identificación de su mascota en el comedero, el dato queda almacenado en la memoria. Esto significa que aunque se cambien las pilas, el comedero seguirá reconociendo a la mascota autorizada para usarlo.



Conectar el comedero

Para completar la configuración del sistema conectado, debe conectar el comedero a su Casa.

1

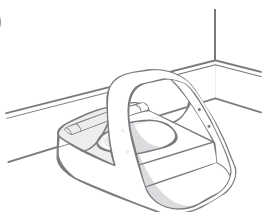

Coloque el comedero en la ubicación correcta. Eso es importante para que pueda comunicarse con el Concentrador.

2



En la aplicación Sure Petcare, seleccione **Agregar producto**.

3



El Concentrador entrará en modo de conexión y las orejas emitirán destellos verdes.

4

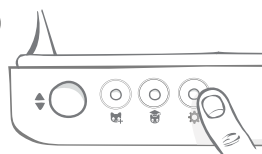

Pulse una vez el botón de configuración "⚙️" en el comedero. El LED de la oreja se iluminará en verde.

5

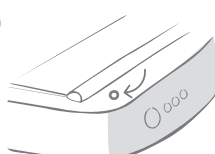

Cuando el comedero esté conectado, el LED se apagará y el Concentrador dejará de emitir destellos.

i

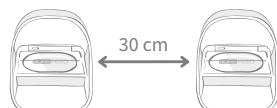

Si desea conectar más comederos, puede hacerlo fácilmente desde la aplicación.

Agregar un comedero a su Casa actual



Puede agregar un Comedero para mascotas con microchip Connect a su Casa de Sure Petcare existente a través de la aplicación. Vaya a la sección Casa y siga las instrucciones anteriores.

También puede usar la aplicación para asignar el microchip de identificación de su mascota de forma remota. Así no tendrá que agregarlos manualmente. Pero puede que recurrir a comida apetecible para agregar mascotas incentive el uso del nuevo producto. **Consulte la página 127** para obtener más información sobre cómo agregar mascotas.



Botones y luces

Botones

Hay 5 botones en el comedero. Se encuentran en la parte posterior del producto:

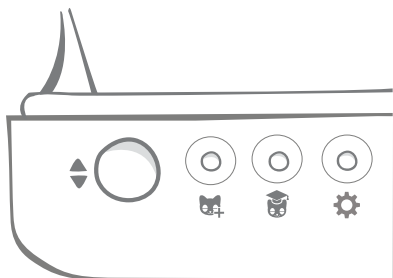

Botón Abrir/Cerrar - Abre y cierra la tapa para permitir el acceso a los platos.



Botón Agregar una mascota - Se utiliza para agregar el microchip de identificación al comedero (véase la página 127).



Botón de modo de entrenamiento - Se utiliza para activar el modo que sirve para enseñar a la mascota a usar el comedero (véase la página 131-132).



Botón de configuración - Se utiliza para conectar el comedero y el Concentrador (véase la página 124).



Botón cero - Se utiliza para calibrar el comedero y asegurar que suministra la cantidad correcta de alimento (véase la página 129). Este botón pondrá a cero **ambos lados del comedero, tanto si se usa un plato estándar como medios platos.**



Si usa **medios platos** y quiere ponerlos a cero individualmente, puede hacerlo mediante la **aplicación Sure Petcare.**

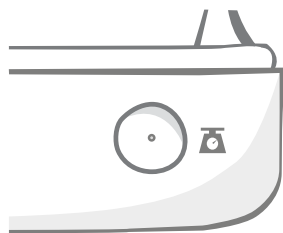

Bloqueo de la tapa



Bloqueada - Significa que no puede extraer la tapa del comedero.



Desbloqueada - Puede extraer la tapa cuando esté abierta.

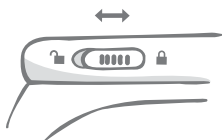

La tapa debe **permanecer bloqueada** en todo momento y solo debe desbloquearse cuando se vaya a limpiar y haya que quitarla. Con esa medida se evita que algunas mascotas ajenas muy listas quiten la tapa para acceder a la comida. **Tenga en cuenta que eso no impide que la tapa se abra.**

LED posterior

Luz verde permanente. La luz verde se encenderá cada vez que una mascota autorizada esté comiendo.

Luz verde intermitente. El comedero está en modo “Agregar una mascota” (véase la página 127). La luz seguirá emitiendo destellos hasta que se agregue un microchip o se desactive el modo.

Luz naranja intermitente. El comedero está en modo de entrenamiento (véase la página 131-132). El número de destellos depende de la fase de entrenamiento.

Luz roja intermitente. Las pilas se están agotando.

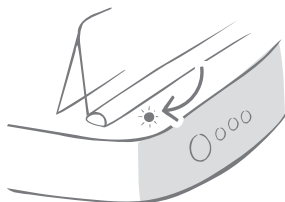

Luces indicadoras de porción

Si ha establecido un peso de porción en la aplicación Sure Petcare, las luces en la parte frontal del comedero le guiarán al agregar la comida.

Las luces indicadoras de porción representarán la cantidad de alimento que ha agregado, para que la mascota reciba siempre la porción correcta.

Para obtener más información sobre las ventajas de usar la porción correcta, consulte la página 128.

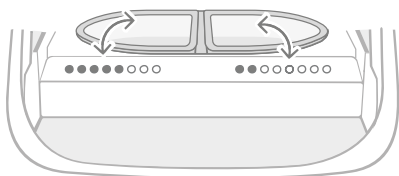
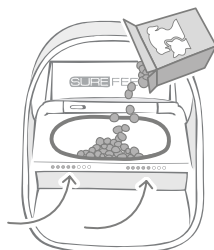

Usar medios platos

Las luces a ambos lados del comedero corresponden a los respectivos medios platos. Las luces se iluminarán al agregar comida en cada uno de los lados.

Usar un plato estándar

Ambos grupos de luces se iluminarán simultáneamente al agregar comida al plato estándar.

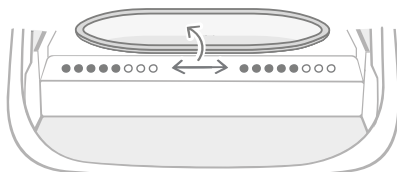

Si quiere pasar de usar medios platos a un plato estándar, o viceversa, debe hacer el cambio en la aplicación Sure Petcare.



A menos que haya configurado ya un peso de porción en la aplicación, las luces correspondientes no se iluminarán al agregar comida al comedero.



Agregar su mascota al comedero

Cuando agregue el microchip de identificación de su mascota al comedero para mascotas con microchip Connect, asegúrese de que no haya ninguna otra mascota ni otras placas identificadoras en las proximidades.

1

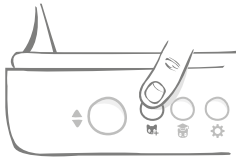

Pulse el botón Agregar una mascota (🐱) en la parte posterior del comedero.

2

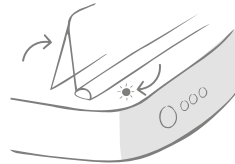

La tapa se abrirá y el LED posterior emitirá destellos verdes a intervalos de un segundo.

3

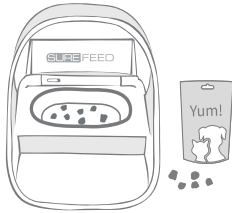

Ponga un poco de comida o una golosina en el plato y coloque el comedero en el lugar donde alimente a su mascota habitualmente.

4



Mientras la mascota come, el comedero escanea su microchip de identificación. Después de agregarse la identificación, **el LED deja de emitir destellos** (pero permanece iluminado).

5

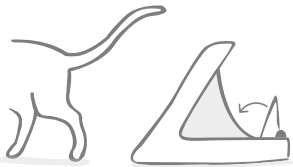

Cuando su mascota se aleje del comedero, la tapa se cerrará y el LED verde se apagará. El microchip de identificación se almacena de forma permanente.

i



Si es necesario, puede cancelar el modo “Agregar una mascota” en cualquier momento pulsando por segunda vez el botón “Agregar una mascota” (🐱).



Para programar el microchip de identificación de una mascota, los sensores ubicados en el aro del comedero deben detectar la presencia de la mascota. Por lo tanto, es importante asegurarse de que la mascota pase la cabeza por el aro para comer.



Para programar una placa de identificación mediante radiofrecuencia Sure Petcare, simplemente siga los pasos anteriores pero mantenga la placa identificadora dentro del aro. Asegúrese de no llevar puesto ningún accesorio metálico cuando programe una placa identificadora.



Si ya tiene una mascota en su Casa de Sure Petcare, puede asignarla al comedero. Vaya a la sección Casa en la aplicación. Si agrega una mascota erróneamente, puede corregirlo ahí.



Configurar porciones

El comedero para mascotas con microchip Connect no solo supervisa cuándo y qué ha comido su mascota; también puede ayudarle a dosificar con precisión las porciones de comida.

¿Por qué es conveniente dosificar la comida de una mascota?

Puede que su mascota necesite perder algún kilo. Al establecer un peso de porción, se asegura de no sobrealimentarla a diario.

La posibilidad de pesar porciones de comida directamente en el comedero facilita el suministro de la cantidad adecuada.

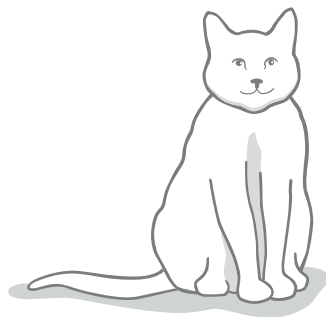

¿Qué cantidad de alimento necesita su mascota?

Puede ser difícil saber cuánta comida necesita su mascota, especialmente cuando hay tantas opciones de alimentación. Le aconsejamos que lo consulte con su veterinario.

Otra posibilidad es seguir las indicaciones que los fabricantes proporcionen en los envases de comida para mascotas. Esta información suele ser adecuada para la mayoría de mascotas sanas.

Cómo configurar el peso de la porción en la aplicación

Puede configurar el peso de la porción en la aplicación Sure Petcare. Una vez configurada, la cantidad se envía al comedero para que sepa cuánta comida servir en cada ración.

Las luces indicadoras de porción en el comedero le servirán de guía al agregar comida, para que su mascota reciba siempre la cantidad correcta de alimento. Las luces representan la cantidad de comida agregada, **consulte la página 130** para más información.





Agregar y cambiar comida

Es importante que cambie la comida a diario, no solo para mantener sana y satisfecha a su mascota, sino también para tener el comedero limpio y en buenas condiciones de funcionamiento.

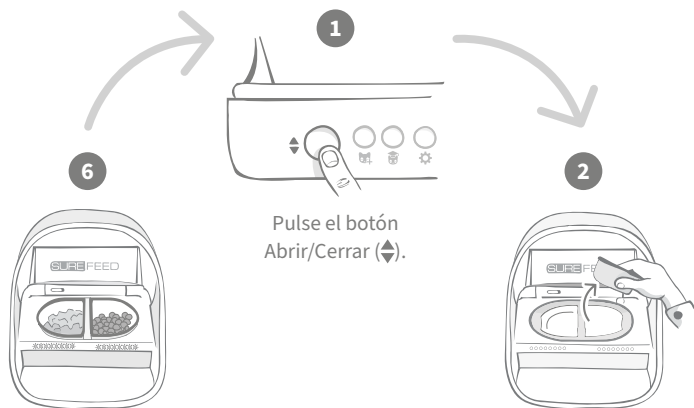

Pulse el botón
Abrir/Cerrar (↕).

Cuando todas las luces emitan destellos verdes, los platos tienen la porción completa.

Retire los platos sucios y cualquier resto de comida. Limpie los platos o sustitúyalos.

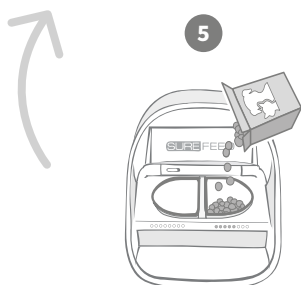

Cuando se complete la secuencia luminosa de puesta a cero, empiece a llenar los platos. Los indicadores de porción se iluminarán para mostrar la cantidad de comida en cada plato; consulte la página siguiente.

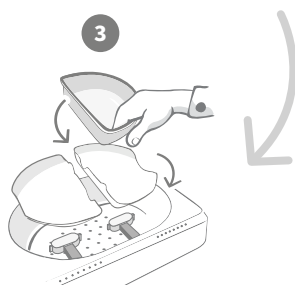

Asegúrese de que los soportes apropiados para cada tipo de plato (estándar o medio) estén correctamente colocados en los brazos de pesaje y **coloque un plato vacío encima**.

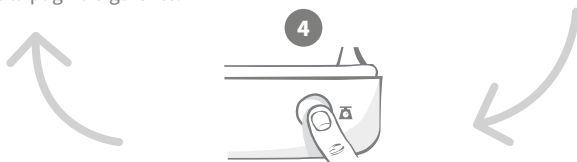

Pulse el botón cero, antes de llenar los platos, para asegurarse de que suministra la porción completa a su mascota. Recuerde que, al pulsar este botón, se ponen a cero **ambos lados del comedero (véase la página 125)**.

Luces indicadoras de porción



Secuencia luminosa de puesta a cero:

Al pulsar el botón cero verá luces verdes de derecha a izquierda.



Agregar comida:

Al agregar comida, se irán iluminando en verde las luces indicadoras de porción, de izquierda a derecha. Las luces corresponden a la cantidad de comida en el plato. Debe seguir agregando comida hasta que todas las luces emitan destellos.



Peso de la porción alcanzado:

Cuando se haya alcanzado el peso de la porción +/-1 g, las luces **emitirán destellos verdes**. Si las luces no emiten destellos, es porque la porción no está completa.



Sobrellenado:

Si coloca en el plato un porción superior a la configurada, las **luces rojas** le indicarán cuánto se ha excedido. Simplemente retire parte de la comida hasta que las luces emitan destellos verdes.



A menos que haya configurado ya un peso de porción en la aplicación, las luces correspondientes **no se iluminarán** al agregar comida al comedero.

¿Queda comida en el plato?

Si todavía queda comida en el plato a la hora de la cena, no hace falta pulsar el botón cero. Simplemente agregue más comida al comedero: podrá agregar una nueva porción a la comida sobrante en el plato. Se puede agregar una cantidad de porción completa y la luz lo indicará así.

1

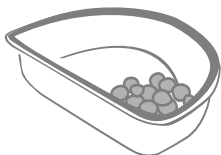

Cuando abra la tapa, algunas luces parpadearán momentáneamente para indicar que el comedero ha detectado que hay comida en el plato. Todas las luces se apagarán para permitir agregar una nueva porción sobre la comida sobrante.

2

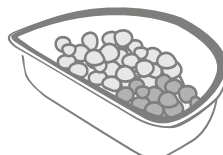

Llene el plato hasta que todas las luces indicadoras de porción emitan destellos verdes.



Modo de entrenamiento

(para enseñar a su mascota a usar el comedero)



Al usar el botón Abrir/Cerrar, la luz naranja de entrenamiento emitirá destellos rojos; eso significa que el comedero está en modo abierto. La luz de entrenamiento volverá a ser naranja cuando se pulse el botón Abrir/Cerrar después de agregar la porción de comida.

Si no se pulsa el botón Abrir/Cerrar, las luces indicadoras de porción no se activarán y el sistema no podrá identificar si se agrega comida.

PARTE 1: Enseñar a su mascota a usar el comedero

Algunas mascotas pueden tardar un tiempo en acostumbrarse al comedero. El modo de entrenamiento permite aumentar paulatinamente el movimiento de la tapa, para que la mascota se vaya familiarizando con el comedero. Esto puede requerir algo de tiempo, pero tenga paciencia y no pase a la **PARTE 2** hasta que vea que su mascota se ha habituado.

1

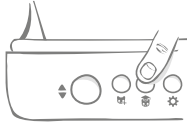

Con la tapa cerrada, pulse una vez el botón de entrenamiento (🎓) situado en la parte posterior del comedero. La tapa se abrirá y el LED posterior emitirá destellos naranjas (una vez cada varios segundos).

2

Llene el plato con la comida favorita de su mascota y coloque la unidad en el lugar habitual u otro donde pueda comer a gusto.

3



Durante esta primera fase de entrenamiento, **la tapa no se cerrará** después de que la mascota acabe de comer.



Tenga paciencia y deje que su mascota se acostumbre al nuevo plato. Cuando se sienta a gusto, siga con la PARTE 2.

PARTE 2: Aumentar el movimiento de la tapa

Aumentar poco a poco el movimiento de la tapa permite que la mascota se acostumbre al movimiento en tres fases. Una vez más, para obtener los mejores resultados y que su mascota se sienta a gusto, es importante ser paciente y no acelerar este proceso. La cantidad de tiempo requerida varía según la mascota (días o semanas) pero le recomendamos que dedique varios días a cada fase.

4

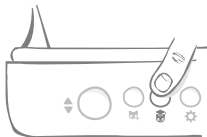

Empiece por incrementar el movimiento de la tapa, pulsando el botón de entrenamiento (🎓) otra vez. La tapa se cerrará un poco y el LED posterior emitirá dos destellos naranjas.

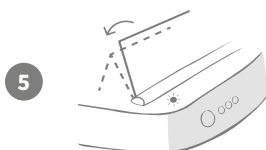

5

Ahora cuando su mascota se alimente habrá cierto movimiento, al abrirse completamente la tapa. Cuando acabe de comer, la tapa se cerrará parcialmente.



6

Deje que su mascota se acostumbre al nuevo movimiento de la tapa. Cuando tenga que cambiar la comida, hágalo de la forma habitual (véase la página 129). Después de poner la comida nueva, asegúrese de pulsar el botón Abrir/Cerrar (↕) para cerrar la tapa en la posición de entrenamiento.



Tómeselo con calma. No pase a la siguiente fase hasta que su mascota se habitúe al movimiento de la tapa.

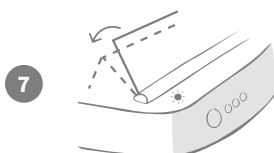

7

Cuando su mascota se haya acostumbrado, pulse de nuevo el botón de entrenamiento (🐾). La tapa se cerrará un poco más hasta su siguiente posición y el LED posterior emitirá 3 destellos naranjas.



Una vez más, siga usando el comedero de la forma habitual y no pase a la siguiente fase hasta que su mascota se haya acostumbrado al movimiento.

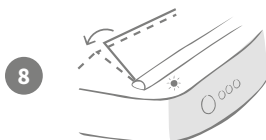

8

Su mascota ya debería estar familiarizada con el movimiento, así que en esta fase final la tapa se cerrará un poco más. Vuelva a pulsar el botón de modo de entrenamiento (🐾). La tapa se cerrará completamente y el LED posterior emitirá 4 destellos naranjas.



9

Cuando la mascota parezca habituada a la posición final, vuelva a pulsar (🐾). La tapa se cerrará totalmente y el LED posterior dejará de emitir destellos. A partir de ahora, el comedero estará sellado y en modo de uso habitual.



Puede dar por terminado el modo de entrenamiento en cualquier momento, manteniendo pulsado el botón correspondiente (🐾) durante **5 segundos**.



Si necesita volver a una fase anterior, haga lo indicado arriba. Así se desactiva el modo de entrenamiento del comedero para mascotas y, a continuación, puede reiniciar el proceso desde el principio.



Si a su mascota le inquieta el movimiento de la tapa al terminar de comer, puede usar la aplicación Sure Petcare para ajustar el retardo de cierre.



Limpieza y mantenimiento

Es importante que mantenga el comedero para mascotas con microchip Connect limpio para que funcione bien. **No sumerja la unidad completa en agua, ni la ponga bajo el grifo. El agua puede dañar el comedero y sus componentes electrónicos.**

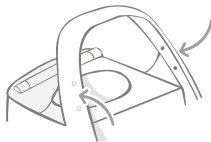
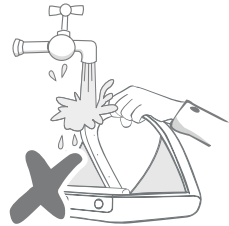

Asegúrese de que los cuatro puntos negros en el aro estén siempre limpios. La alfombrilla se puede limpiar con un paño húmedo.

No meta ningún componente en el lavavajillas. Lávelos a mano.

El comedero para mascotas con microchip Connect incluye una **tapa de limpieza** en la base, para facilitar la extracción de migajas y otros residuos.

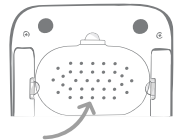

Cómo extraer la tapa para limpiarla

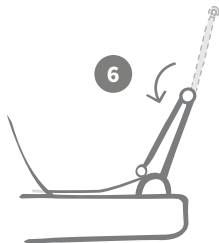

Voltee hacia atrás la mitad superior de la tapa, de modo que quede apoyada en las guías de la tapa.

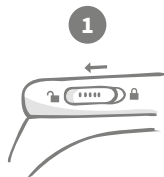

Coloque el control deslizante de bloqueo de la tapa en la posición desbloqueada.



Pulse el botón (◊). Cuando la tapa esté abierta, tire de ella hacia arriba.

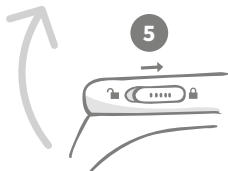

Vuelva a colocar el control deslizante de bloqueo de la tapa en la posición bloqueada.

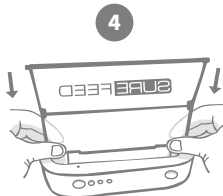

Después de la limpieza, vuelva a colocar la tapa, manteniendo ambas mitades en posición vertical. Asegúrese de que esté bien ajustada.

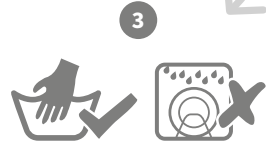

Lávala a mano. **No la meta en el lavavajillas.**

Cómo garantizar la limpieza del comedero

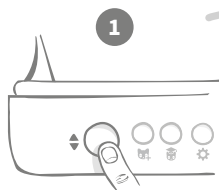

1
Pulse el botón
Abrir/Cerrar (↕).

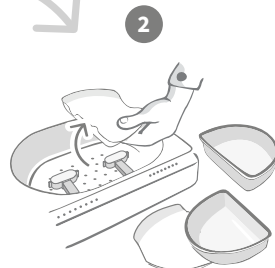

2
Retire los platos, los soportes y la tapa
(véase la página anterior).



7
Vuelva a colocar todos los componentes,
en primer lugar la tapa de limpieza.



3
Si hay restos de comida alrededor de
los brazos de pesaje, pueden afectar
al funcionamiento del comedero.
Asegúrese de que esa zona esté limpia.

No utilice esponjas/estropajos abrasivos
ya que pueden dañar el comedero
y afectar al funcionamiento.

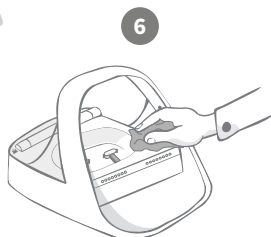

6
Use un paño húmedo para
limpiar todas las superficies del
comedero. **No utilice productos
de limpieza abrasivos.**

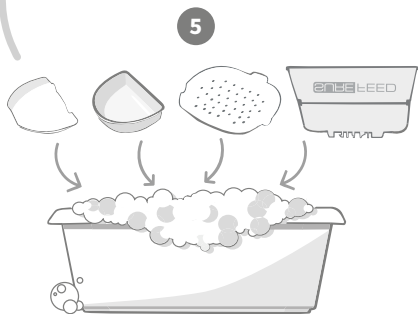

5
**Lave a mano todos los
componentes extraíbles.**
No los meta en el lavavajillas.

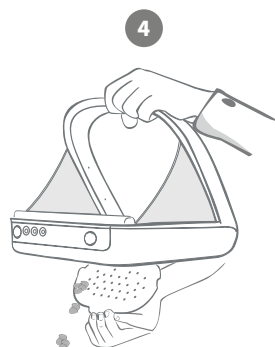

4
Sostenga el comedero sobre el cubo
de la basura, retire la tapa de limpieza
y deje que caigan los residuos.



Ayuda y soporte

Ajustes personalizados

Sabemos que no todas las mascotas se comportan de la misma manera y lo hemos tenido en cuenta al diseñar el comedero para mascotas con microchip Connect. El comedero tiene varios ajustes específicos para casos en que las mascotas lo usan de forma imprevista o inusual. A continuación se muestran algunos ejemplos de comportamiento para los que esos ajustes pueden ser útiles.

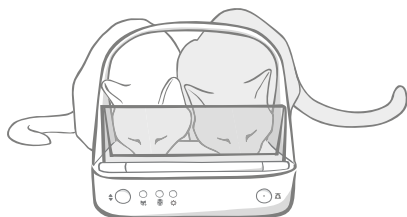

¿Tiene una mascota no autorizada que se presenta a comer a la misma hora que la mascota autorizada?

¡Tenemos un ajuste específico para eso!

¿Tiene una mascota no autorizada aficionada a robar comida del comedero de otra mientras está en modo de entrenamiento?

¡Tenemos un ajuste específico para eso!

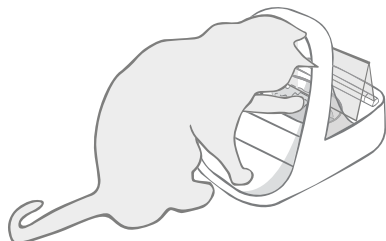

¿Tiene una mascota no autorizada que ha descubierto cómo impedir que se cierre la tapa?

¡Tenemos un ajuste específico para eso!

¿Tiene una mascota no autorizada que intenta robar comida por la parte posterior del comedero?

¡Tenemos un accesorio para eso!

Vaya a [surepetcare.com/accessories](https://www.surepetcare.com/accessories) y busque el artículo Rear Cover.

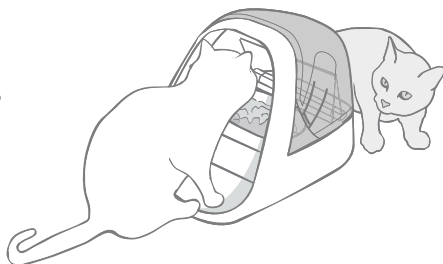

Póngase en contacto con nuestro equipo de atención al cliente para comentar ajustes concretos (**encontrará detalles de contacto en la contraportada**). Podrán recomendarle el ajuste más apropiado en su caso y configurarlo de forma remota.

El Concentrador

Orejas rojas intermitentes

El Concentrador ha perdido la conexión con el comedero para mascotas con microchip Connect.

- Si ve que **ambas orejas emiten destellos rojos durante la instalación**, restablezca la configuración de fábrica pulsando el botón en la base del Concentrador durante 10 segundos.
- Si ve que **ambas orejas emiten destellos rojos durante un periodo prolongado tras la instalación**, apague y vuelva a encender el Concentrador. Apague el interruptor en la toma de alimentación y espere 30 segundos antes de volver a encenderlo. Si las orejas permanecen verdes durante unos minutos, el Concentrador se ha vuelto a conectar.
- También puede **colocar el Concentrador** siguiendo los consejos en la **página 121**. Si eso no da resultado, tendrá que acercar el Concentrador al comedero (consulte la información a continuación).
- Para acercar el Concentrador, conéctelo al enrutador con un cable Ethernet más largo.
- Si eso no da resultado, recomendamos comprar un **adaptador para Ethernet a través de línea eléctrica**. Se conecta a una toma de corriente normal y permite conectar el Concentrador a Internet más cerca del comedero.

Orejas alternantes (luz roja o verde)

El Concentrador tiene problemas para conectarse a los servidores de Sure Petcare.

Esto podría deberse a una conexión a Internet inestable.

- Apague el Concentrador en la toma de corriente y espere 30 segundos antes de volver a encenderlo. Si las orejas permanecen verdes durante unos minutos, el Concentrador se ha vuelto a conectar.
- Si lo anterior no da resultado, asegúrese de que el enrutador de Internet esté encendido y que su conexión a Internet funcione correctamente con otros dispositivos.
- Si no funciona con otros dispositivos, apague el enrutador y vuelva a encenderlo al cabo de 30 segundos.
- Si el enrutador funciona con otros dispositivos, vuelva a conectar el cable Ethernet al enrutador y al Concentrador. Asegúrese de que el cable encaje: podría parecer conectado sin estarlo realmente.

Si sigue teniendo problemas de conectividad, visite: surepetcare.com/hub-connectivity

Orejas rojas permanentemente

El Concentrador tienen una actualización de firmware en curso. Tenga paciencia y espere a que las orejas del Concentrador muestren la luz verde. No debería tardar más de 2 minutos. Al completarse la actualización del firmware, el Concentrador debería reiniciarse. En el reinicio verá la secuencia luminosa de configuración (**véase la página 122**).

Notificaciones lentas

Si algunos mensajes tardan en aparecer en su aplicación, es probable que el Concentrador tenga dificultades para conectarse al comedero para mascotas con microchip Connect. Para mejorar la velocidad de los mensajes, coloque el Concentrador en otra ubicación, siguiendo los consejos indicados en la **página 121**.

Comedero para mascotas con microchip Connect

Si el comedero tiene algún problema mecánico, no intente solucionarlo por su cuenta. Póngase en contacto con nuestro equipo de servicio al cliente; encontrará los detalles en la **contraportada**.

El comedero no se abre para que lo use mi mascota

- Asegúrese de que los 4 sensores del aro estén limpios: (**véase la página 133**).
- Compruebe que las pilas instaladas sean **alcalinas** de buena calidad y que no se estén agotando. Los polos + y - de las pilas deben estar correctamente orientados (**véase la página 123**).
- Aleje el comedero de cualquier dispositivo metálico o eléctrico. Si el comedero sigue sin abrirse para su mascota autorizada, continúe leyendo.
- Asegúrese de que no haya fuentes evidentes de ruido eléctrico en las inmediaciones (por ejemplo, luces defectuosas o titilantes). Si sospecha que hay alguna, llame a nuestro equipo de atención al cliente (**los detalles de contacto figuran en la contraportada**).
- Si lo anterior no da resultado, consulte a su veterinario para comprobar que el microchip de su mascota funciona y está situado en el lugar debido. Si se ha movido mucho, se habrá vuelto difícil de leer. Mientras tanto, puede utilizar la placa de identificación mediante radiofrecuencia Sure Petcare proporcionada. Ponga la placa identificadora en el collar de su mascota y repita el proceso “Agregar una mascota” (**vea las páginas 127**).

A mi mascota no parece gustarle el comedero

- Repita el proceso de entrenamiento, dejando más tiempo entre fases para que su mascota se acostumbre (**véase la página 131-132**).
- Si una mascota sigue desconfiando del comedero, siga los pasos detallados en **surepetcare.com/cautiouspet** y no obligue a la mascota a comer en ningún momento.
- Evalúe la zona de comidas de su mascota. ¿Se acerca al plato siempre desde el mismo ángulo? ¿Parece inquieta por tener la puerta detrás? Dado que no es preciso colocar el comedero en una orientación específica, puede elegir la que quiera para que la mascota se sienta a gusto.
- Si el retardo del cierre de la tapa (cuando la mascota acabe de comer y se aparte del comedero) no es el adecuado, puede usar la aplicación Sure Petcare para incrementar/reducir el tiempo.

El comedero no se cierra completamente

- Probablemente se deba a que hay restos de comida bajo la tapa o en el mecanismo. Para que la tapa se cierre correctamente, es importante eliminar restos de alimentos de las superficies del comedero (**véase la página 133-134**).
- Asegúrese de no estar en un modo de entrenamiento, **visite la página 131** para obtener más información sobre el modo de entrenamiento.

Las luces indicadoras de porción están encendidas pero el plato está vacío

Si al abrir el comedero algunas de las luces indicadoras de porción son verdes, aunque no quede comida en los platos, es necesaria una puesta a cero. Es importante pulsar siempre el botón cero antes de cambiar la comida (**véase la página 129-130**).

Las luces indicadoras de porción no responden

- A menos que haya configurado ya un peso de porción en la aplicación Sure Petcare, las luces correspondientes no se iluminarán al agregar comida al comedero.
- Además, si hay restos de comida alrededor de los brazos de pesaje, pueden afectar al funcionamiento del comedero. Asegúrese de que esa zona esté limpia (**véase la página 133-134**).

Otros animales roban la comida de mi mascota

- Si otros animales roban comida del comedero abierto, use la aplicación Sure Petcare para reducir el tiempo que tarda en cerrarse la tapa después de que su mascota acabe de comer.
- Puede que haya un ajuste específico para resolver su problema. Póngase en contacto con nuestro equipo de atención al cliente para comentar su situación (**los detalles de contacto figuran en la contraportada**).
- En caso de haber mascotas glotonas que roban comida por la parte posterior o lateral del comedero (mientras la tapa está abierta y la mascota autorizada está comiendo), puede usar una tapa posterior para combatir comportamientos tan astutos y tenaces. Para obtener más información, visite surepetcare.com/accessories.

Pilas de corta duración

- Asegúrese de que el comedero esté limpio y no haya suciedad que obstruya los sensores (**véase la página 133**).
- Asegúrese de que las pilas utilizadas sean de buena calidad y estén correctamente colocadas (**véase la página 123**).
- Asegúrese de que no haya fuentes evidentes de ruido eléctrico en las inmediaciones (por ejemplo, luces defectuosas o titilantes). Si sospecha que hay alguna, llame a nuestro equipo de atención al cliente. Encontrará los detalles de contacto en la **contraportada**.

Casas con varios comederos

- Si usted o sus mascotas se confunden a menudo de comedero, pruebe a usar platos de distintos colores y ubicaciones más claramente separadas. Las alfombrillas y los platos de colores se venden por separado. Para obtener más información, visite surepetcare.com/accessories.

¿Necesita más ayuda?



- Si sigue teniendo problemas de conectividad, visite: surepetcare.com/hub-connectivity
- Si quiere ver más información, vídeos y foros de ayuda para usuarios, visite: surepetcare.com/support
- Si tiene problemas con su aplicación Sure Petcare, visite: surepetcare.com/apphelp

O puede ponerse en contacto con nuestro equipo de atención al cliente. **En la contraportada verá los detalles.**



Garantía/Renuncia de responsabilidad

Garantía: El comedero para mascotas con microchip SureFeed Connect tiene una garantía de 3 años a partir de la fecha de compra, sujeta a la presentación de una prueba de la fecha de compra. La garantía se restringe a cualquier fallo producido por materiales, componentes o fabricación defectuosos. Esta garantía no se aplica a productos cuyo defecto se deba al desgaste normal, uso indebido, descuido o daños intencionales. En el caso del fallo de una pieza debido a un defecto interno o de fabricación, la pieza se sustituirá gratuitamente solo durante el periodo de garantía. A discreción del fabricante, se podría sustituir el producto en caso de mal funcionamiento grave. Esto no afecta sus derechos legales.

Renuncia de responsabilidad: El comedero para mascotas con microchip Connect y la aplicación notifican el consumo de comida de las mascotas basándose en el microchip de identificación y midiendo el peso del plato antes y después de que terminen de comer. En la mayoría de los casos, esto proporcionará datos fiables sobre el consumo de comida; pero un uso imprevisto o inusual del comedero (por ejemplo, una mascota que quita el plato o juega con la comida) puede generar información de fiabilidad cuestionable. Sure Petcare no puede aceptar la responsabilidad por ningún daño o contratiempo que pudiera producirse como resultado de un informe incorrecto del consumo de alimentos para mascotas.

El comedero para mascotas con microchip SureFeed Connect incorpora funciones de entrada selectiva que se han diseñado para reducir al mínimo el riesgo de que otros animales se coman el alimento de su mascota. Sin embargo, no es posible garantizar la exclusión de los demás animales en todas las circunstancias. En el caso poco probable de que una mascota no autorizada lograra acceso al comedero, Sure Petcare no puede aceptar la responsabilidad por ningún daño o molestia que pudiera producirse.



Eliminación de productos y pilas usadas: Este icono identifica los productos que están sujetos a la siguiente legislación:

La Directiva sobre residuos de aparatos eléctricos y electrónicos 2012/19/UE (directiva RAEE), y la Directiva sobre pilas 2006/66/EC (y la Enmienda 2013/56/UE) estipulan la obligación de los hogares particulares de desechar los aparatos eléctricos y electrónicos y las pilas gastadas que hayan alcanzado el fin de su vida útil de una forma responsable con el medio ambiente. Para reducir el impacto en el medio ambiente, no pueden depositarse en los cubos de basura normales, sino que deben reciclarse en una instalación de reciclaje apropiada. Para obtener más información sobre el reciclaje, visite: www.recycle-more.co.uk.

Las pilas deben sustituirse antes de la fecha de caducidad indicada en ellas o en su embalaje; y se deben desechar de modo seguro y apropiado.

En caso de fugas de pilas, utilice prendas protectoras al manipularlas y limpiar derrames, para evitar la exposición a sustancias químicas perniciosas. Al limpiar derrames, evite que la sustancia entre en contacto con la piel. Los componentes químicos de las pilas no deben ingerirse ni acercarse a los ojos. En caso de ocurrir así, solicite atención médica inmediatamente.

Conformidad con las normas FCC: Este dispositivo cumple con la Parte 15 de las normas de la FCC. Su uso está sujeto a estas dos condiciones:

- (1) este dispositivo no puede causar interferencias perjudiciales, y
- (2) este dispositivo debe aceptar cualquier interferencia recibida, incluidas interferencias que puedan causar un funcionamiento no deseado.

Los cambios o modificaciones no aprobados expresamente por la parte responsable del cumplimiento podrían anular la autorización del usuario para usar el equipo. Este dispositivo ha sido diseñado y cumple con los requisitos de seguridad para la exposición a radiofrecuencia, de acuerdo con la norma de la FCC, parte 2.1093 y KDB 447498 D01.

Marcas comerciales: Google Play y el logotipo de Google Play son marcas comerciales de Google Inc. Apple es una marca comercial de Apple Inc., registrada en EE. UU. y otros países. App Store es una marca de servicio de Apple Inc., registrada en EE. UU. y otros países. IOS es una marca comercial o una marca comercial registrada de Cisco en EE. UU. y otros países y se utiliza bajo licencia.



SURE[™]
PETCARE

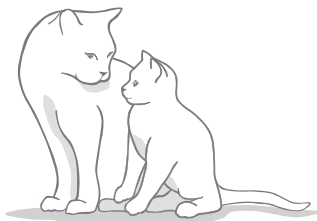

Ecco il tuo nuovo Distributore di cibo con lettore di microchip Connect

Grazie per aver scelto il Distributore di cibo con lettore di microchip Connect.

Il sistema Distributore di cibo con lettore di microchip Connect è costituito da tre elementi che insieme contribuiscono a mantenerti connesso al tuo animale domestico e a fornirti maggiori informazioni sulle sue abitudini alimentari.

Il **Distributore di cibo con lettore di microchip Connect** è il componente principale del sistema: è in grado di riconoscere l'ID del microchip già impiantato nel tuo animale domestico o la Targhetta per collare RFID Sure Petcare (una inclusa), consentendo solo a lui di accedere alla sua ciotola.

L'**Hub** (venduto separatamente) è l'elemento del sistema che richiede una connessione alla rete domestica per poter comunicare con il distributore di cibo e con l'app Sure Petcare.

Tramite l'**app Sure Petcare** sarai in grado di controllare quanto cibo ha mangiato il tuo animale e la frequenza con cui si reca alla ciotola. L'app ti consente inoltre di impostare nel distributore il peso di ogni porzione, in modo da poterne controllare la quantità.

Contenuto della confezione

Controlla che siano presenti tutti questi componenti*

- 1 1 Distributore di cibo con lettore di microchip Connect
- 2 1 Ciotola singola
- 3 2 Mezze ciotole
- 4 1 Tappetino
- 5 1 Supporto per ciotola singola
- 6 2 Supporti per mezzette ciotole
- 7 1 Targhetta per collare RFID Sure Petcare

*Batterie e Hub non inclusi

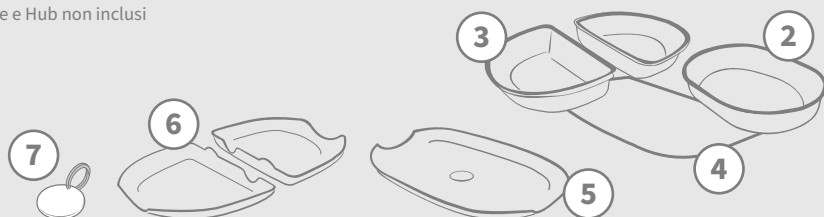
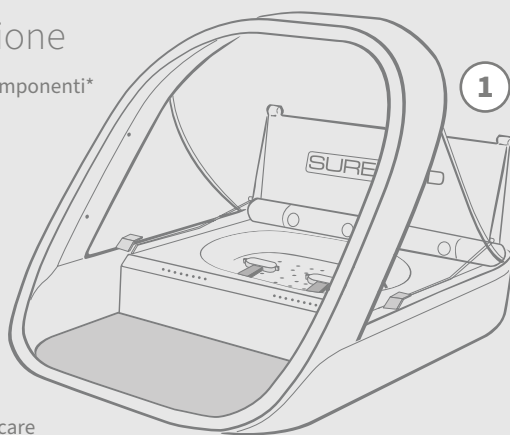

Affinché il Distributore di cibo con lettore di microchip Connect funzioni come un sistema connesso, dovrai acquistare un Hub dedicato. Per ulteriori informazioni su come acquistarlo, visita la pagina surepetcare.com/hub.

Indice

Informazioni importanti.....	144
Panoramica del prodotto	146
Sistema Distributore di cibo con lettore di microchip Connect.....	148
Hub	
Come impostare l'Hub	149
Dove posizionare l'Hub.....	150
Le luci dell'Hub.....	151
Distributore di cibo	
Batterie	152
Come connettere il distributore di cibo	153
Pulsanti e luci	154
Come aggiungere il tuo animale al distributore	156
Come impostare le porzioni	157
Come aggiungere e sostituire il cibo	158
Modalità addestramento	160
Pulizia e manutenzione	162
Guida e assistenza	164
Garanzia e dichiarazione di non responsabilità.....	168



Informazioni importanti



LEGGERE ATTENTAMENTE LE SEGUENTI INFORMAZIONI E CONSERVARE QUESTO MANUALE PER RIFERIMENTI FUTURI.



L'uso di questo prodotto è destinato **esclusivamente ad animali domestici.**



Utilizzare solo accessori SureFeed per garantire la compatibilità: surepetcare.com/accessories



Controlla che siano presenti tutti i componenti elencati a **pagina 141.**



Non posizionare il distributore di cibo in zone di passaggio frequente.



Il distributore è progettato per essere **utilizzato solo in ambienti chiusi.**



Non immergere il distributore o posizionarlo sotto un getto di acqua corrente.



Non mettere il distributore di cibo nel frigorifero, non inserirvi del ghiaccio dentro o sotto.



Non posizionare il distributore in luoghi in cui potrebbe essere esposto a un calore eccessivo.



Questo prodotto richiede **4 batterie C** che devono essere inserite e sostituite con cautela. Non utilizzare tipi diversi di batterie insieme e non combinare batterie nuove e usate. Se prevedi di non utilizzare il distributore per un lungo periodo, rimuovi le batterie dal dispositivo.

Puoi trovare il **codice prodotto** e il **numero di serie** sotto il Distributore di cibo con lettore di microchip Connect.

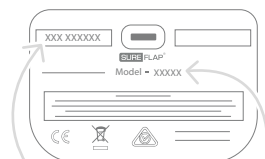

Numero di serie Codice prodotto

Avvertenze di sicurezza

- **Non** utilizzare questo prodotto se alcuni componenti sono mancanti, danneggiati o presentano segni di usura.
- **Per la costruzione del dispositivo sono stati utilizzati pezzi piccoli.** Eventuali parti allentate devono essere tenute lontane da bambini e animali domestici per **evitare rischi di soffocamento.**

Altri aspetti importanti da considerare



ANIMALI: Sure Petcare consiglia di collegare il Distributore di cibo con lettore di microchip Connect SureFeed al microchip del tuo animale domestico, ma puoi collegarlo anche alla Targhetta per collare RFID Sure Petcare. In questo caso, ti consigliamo di utilizzarla con un collare che preveda una **chiusura di sicurezza** (solo per gatti). Sure Petcare non si assume alcuna responsabilità per eventuali lesioni o decessi causati dal collare di un animale domestico.



ACCESSO AL CIBO: Sure Petcare non può essere ritenuta responsabile se degli animali non autorizzati accedono alla ciotola a causa di un uso improprio del dispositivo. In qualità di proprietario, **ti assumi la piena responsabilità di controllare la somministrazione di qualsiasi alimento** che potrebbe nuocere ad altri animali se consumato involontariamente.



FUNZIONAMENTO SENZA TIMER: questo dispositivo non dispone di un timer integrato e **non offre alcuna funzionalità a tempo**. Ti consigliamo, pertanto, di non lasciare il tuo animale solo per un lungo periodo (al massimo 24 ore per un gatto, il periodo di tempo che intercorre tra un pasto e l'altro per un cane di taglia piccola), facendo affidamento esclusivamente su questo dispositivo per la fornitura di cibo. **Questo dispositivo non è da intendersi come sostituzione alla cura responsabile dell'animale domestico.**



BAMBINI: non consentire ai bambini di giocare con il Distributore di cibo con lettore di microchip Connect SureFeed. Non è un giocattolo e non deve essere trattato come tale. Tuttavia, questo prodotto può essere utilizzato da bambini dagli 8 anni in su e anche da persone con ridotte capacità fisiche, sensoriali o mentali, purché siano sorvegliati o abbiano ricevuto istruzioni su come utilizzare il prodotto in modo sicuro. Informarli sempre dei potenziali pericoli. Non consentire ai bambini di qualsiasi età di pulire il prodotto senza supervisione.



A PROVA DI BAMBINO: se in casa ci sono dei bambini, è fondamentale **garantire la loro sicurezza quando si utilizza il Distributore di cibo con lettore di microchip Connect SureFeed**. L'uso improprio di questo dispositivo da parte di un bambino può esporlo a potenziali pericoli e, pertanto, è di vitale importanza sorvegliarlo sempre quando si trova nelle immediate vicinanze del distributore. È importante sapere che **il bambino sarà comunque in grado di accedere al cibo anche quando è attiva la modalità addestramento (vedi pagina 159-160)**.



Panoramica del prodotto

Il Distributore di cibo con lettore di microchip Connect è costituito da tre componenti principali:

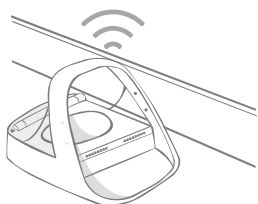

Distributore di cibo con lettore di microchip Connect

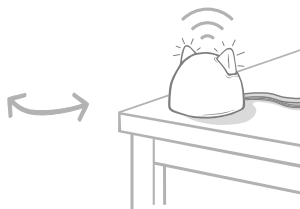

Hub

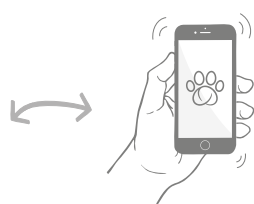

App Sure Petcare

L'Hub è collegato a Internet tramite un cavo Ethernet e monitora l'attività del Distributore di cibo con lettore di microchip Connect. È in grado di comunicare sia con il distributore che con l'app Sure Petcare, permettendoti di visualizzare gli aggiornamenti sull'app anche quando sei fuori casa.

Tramite l'app puoi anche impostare il peso delle singole porzioni. In questo modo, è il distributore stesso a indicarti quanto cibo aggiungere per garantire al tuo animale la razione corretta. Per ulteriori informazioni, **vai alla pagina 154**.

Sensori: per individuare il tuo animale domestico vengono utilizzati quattro sensori all'interno del telaio.

Tappetino: progettato per raccogliere i residui e le briciole di cibo, facilitando la pulizia del distributore.

Luci delle porzioni: vedi pagina 154.

Ciotole e supporti ciotola: vedi pagina 146.

Blocco del coperchio: vedi pagina 153.

Spia LED posteriore: vedi pagina 154.

Pulsanti: vedi pagina 153.

Vani batterie: vedi pagina 151.

Vano di accesso con coperchio per la pulizia: vedi pagina 161.

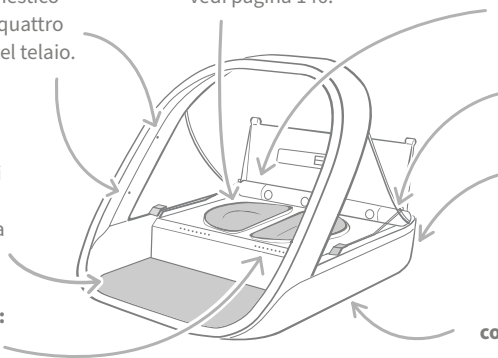

Luci Hub: vedi pagina 150.

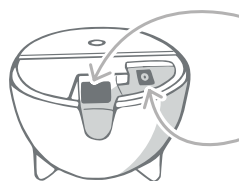

Porta Ethernet: per la connessione al router Internet.

Alimentazione: per collegare il cavo di alimentazione.

Il bordo superiore delle ciotole SureFeed presenta una guarnizione di tenuta integrata che consente di mantenere il cibo fresco più a lungo. Se il tuo animale mangia solo cibo umido o secco, puoi usare la ciotola singola. Se invece li mangia entrambi, le mezze ciotole fanno al caso tuo.



Ciotola singola - può contenere 250 g di cibo, sufficienti per almeno 2 bustine di umido.



Mezze ciotole - ogni ciotola può contenere fino a 100 g, 200 g in totale per entrambe le ciotole.

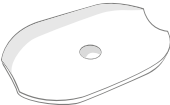

Supporto per ciotola singola - è progettato per contenere la ciotola singola (non le mezze ciotole).



Supporti per mezze ciotole - ogni supporto è progettato per contenere una mezza ciotola (non la ciotola singola).

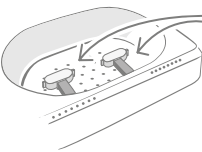

Bracci di pesatura - progettati per sostenere il supporto per ciotola singola.

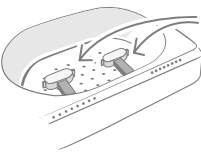

Bracci di pesatura - progettati per sostenere i supporti per mezze ciotole.

Non mettere il cibo direttamente sui supporti per ciotole. Utilizza sempre le ciotole per garantire il corretto funzionamento del distributore.



La ciotola con due scomparti SureFeed non è progettata per essere utilizzata con il Distributore di cibo con lettore di microchip Connect.

Per acquistare altre ciotole o tappetini rivolgiti a un rivenditore Sure Petcare o visita surepetcare.com.

Scegli un look colorato



Le ciotole in plastica e i tappetini SureFeed sono disponibili in quattro diversi colori: blu, verde, rosa e grigio.

o brillante



La ciotola singola SureFeed può essere acquistata anche in acciaio inossidabile.



Non mettere le ciotole in lavastoviglie o nel microonde.



Lavare a mano le ciotole prima del primo utilizzo.



Systema Distributore di cibo con lettore di microchip Connect

Scarica subito l'app gratuita Sure Petcare

SCARICA SU
APP STORE

DISPONIBILE SU
GOOGLE PLAY

 surepetcare.io



Ricevi una notifica quando il tuo animale mangia dal distributore.



Monitora la quantità di cibo che mangia il tuo animale e nota eventuali cambiamenti nel suo comportamento.



Porzioni di cibo accurate per controllare la quantità consumata per ogni porzione.



Condividi con familiari e amici l'accesso alla tua rete domestica.



Scarica subito l'**app Sure Petcare** e crea un account. Ti verrà chiesto di creare una "rete domestica", ovvero una rete che unisce tutti i dispositivi e gli animali domestici connessi a Sure Petcare, alla quale potrai invitare altri membri della tua famiglia.

Per scaricare l'app, il tuo telefono o tablet deve disporre almeno di **iOS 9** per dispositivi **Apple** o della versione **4.4** di **Android**.



Se preferisci controllare i dispositivi connessi a Sure Petcare dal tuo computer, puoi utilizzare l'app Sure Petcare per piattaforme Web su **surepetcare.io**.

Dovrai disporre dell'ultima versione di **Safari**, **Chrome**, **Firefox** o **Internet Explorer** in esecuzione su **Mac OS X v10.9** (o successiva) o **Windows 7** (o successiva).

Acquista un Hub Sure Petcare



Affinché il Distributore di cibo con lettore di microchip Connect possa funzionare con l'applicazione Sure Petcare, dovrai acquistare un Hub dedicato. Per maggiori informazioni, visita il sito **surepetcare.com/hub**.



Come impostare l'Hub

Dopo aver scaricato l'app Sure Petcare, dovrai collegare l'Hub e configurarlo. Al termine della configurazione, ti verrà chiesto di connetterlo al distributore di cibo e all'app seguendo la procedura qui indicata:

1

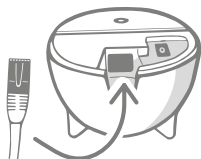

Inserisci un'estremità del cavo Ethernet nella base dell'Hub e l'altra estremità in una porta Ethernet secondaria del router.

2

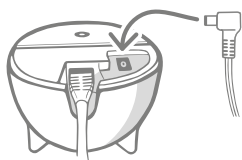

Monta l'alimentatore e inseriscilo nella presa. Collega quindi l'altra estremità del cavo alla base dell'Hub.

3



Le orecchie dell'Hub si accendono **in modo alternato, diventando prima rosse poi verdi**. Quando entrambe le orecchie sono di colore verde fisso, l'Hub è pronto. Se le orecchie non si illuminano in questa sequenza, **consulta la pagina 150** per ulteriori informazioni.

4



Per completare la configurazione del sistema Distributore di cibo con lettore di microchip Connect dovrai **seguire gli ultimi passaggi indicati sull'app Sure Petcare**.



L'Hub potrebbe dover aggiornare il software. Se durante l'installazione le **luci dell'Hub sono rosse e fisse**, significa che il software si sta aggiornando. Una volta completato l'aggiornamento, l'Hub si riavvierà e vedrai la sequenza di luci indicata nel passaggio 3.



Dove posizionare l'Hub

Poiché il Distributore di cibo con lettore di microchip Connect comunica in modalità wireless, la posizione dell'Hub potrebbe influire sulle prestazioni del sistema.



Posiziona l'Hub ad almeno 1 metro da terra (ad esempio su un tavolo, possibilmente senza altri oggetti nelle vicinanze).

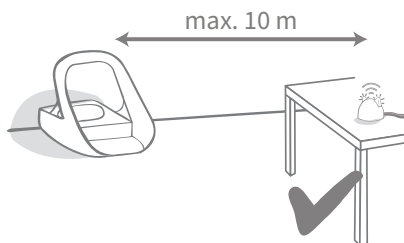

Cerca di allinearli il più possibile al distributore, a una distanza massima di 10 metri.

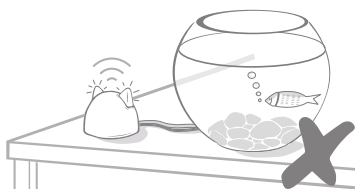

Non sistemare l'Hub in prossimità di contenitori con acqua, come ad esempio degli acquari.

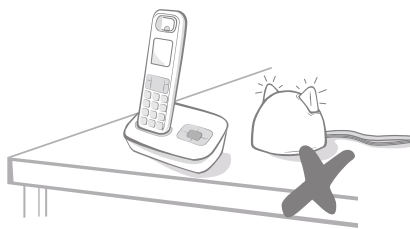

Tieni l'Hub il più lontano possibile da qualsiasi potenziale fonte di interferenza (ad es. cordless digitali, baby monitor, ecc.).



Assicurati che l'Hub non sia posizionato accanto a oggetti metallici di grandi dimensioni (ad es. frigoriferi).

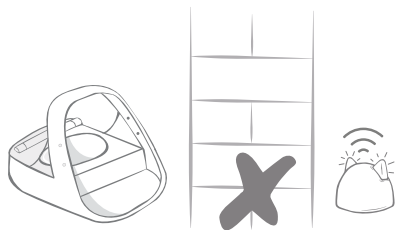

Evita pareti spesse tra l'Hub e il distributore.



Nonostante questi accorgimenti, l'Hub potrebbe comunque avere problemi di connessione. Per ulteriori consigli su come avvicinare l'Hub al Distributore di cibo con lettore di microchip Connect, visita la pagina surepetcare.com/hub-connectivity.



Se l'Hub dovesse disconnettersi da Internet per qualsiasi motivo, il Distributore di cibo con lettore di microchip Connect continuerà a funzionare normalmente e manterrà le sue impostazioni.



Le luci dell'Hub

L'Hub indica il proprio stato utilizzando le luci presenti nelle orecchie. Sequenze di colori diverse indicano stati differenti.

Luci di configurazione

Ogni volta che l'Hub si accende o sta cercando di connettersi ad altri elementi del sistema, si attivano le luci di configurazione:

- 1** le orecchie **si alternano in rosso** per qualche istante,

- 2** poi **in verde**,

- 3** quando le orecchie **lampeggiano brevemente in arancione** e poi diventano **verde fisso**, l'Hub è correttamente collegato.



Orecchie verdi

Le orecchie verdi indicano che l'Hub funziona correttamente. Di seguito è indicato il significato di ciascuna sequenza luminosa.

Entrambe le orecchie sono di colore verde fisso - L'Hub è acceso, è collegato e funziona correttamente.

Orecchie verdi alternate - Il tuo Hub si sta riconnettendo ai nostri server.

Orecchie rosse

Entrambe le orecchie sono di colore rosso fisso - L'Hub sta eseguendo un aggiornamento del software. Con un po' di pazienza, l'Hub si riavvierà e tornerà a funzionare normalmente a breve.

Entrambe le orecchie lampeggiano in rosso - La connessione con il distributore si è interrotta e l'Hub sta tentando di ripristinarla.

Orecchie rosse alternate - L'Hub ha difficoltà a connettersi a Internet e/o ai server.

i Per ulteriori informazioni su questi problemi, **consulta la pagina 164**.



Batterie

Utilizza sempre **4 batterie alcaline C da 1,5 V di buona qualità** per garantire il funzionamento ottimale del Distributore di cibo con lettore di microchip Connect. **Questo dispositivo NON è progettato per essere utilizzato con batterie ricaricabili.** Per inserire o sostituire le batterie, procedi come segue:

i Vicino alla parte posteriore del distributore troverai una luce rossa che lampeggia ogni 5 secondi quando le batterie sono scariche o non sono state inserite correttamente.

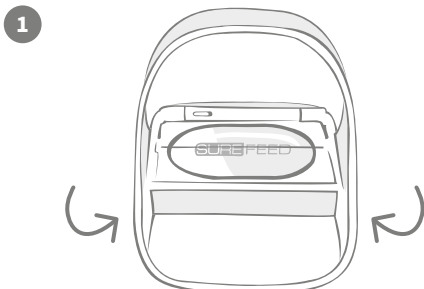

Capovolgilo il distributore per accedere ai vani delle batterie.

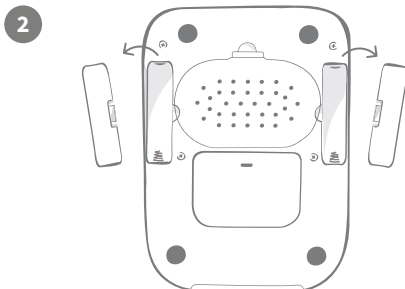

Rimuovi i coperchi.

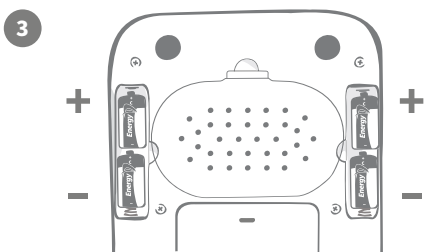

Inserisci le batterie facendo attenzione che i poli + e - corrispondano.

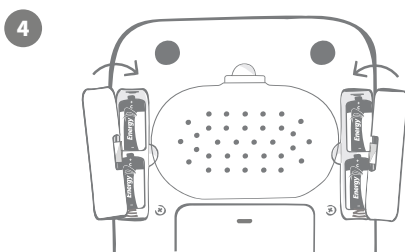

Richiudi i vani con gli appositi coperchi.



Una volta programmato l'ID microchip del tuo animale nel distributore, verrà memorizzato in modo permanente nella sua memoria interna. Ciò significa che anche quando sostituirai le batterie, il distributore continuerà a riconoscere l'animale inserito autorizzato.



Come connettere il distributore di cibo

Per completare la configurazione del sistema, dovrai connettere il distributore alla tua rete domestica.

1

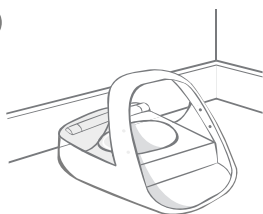

Posiziona il distributore di cibo nella posizione desiderata, in modo che possa comunicare correttamente con l'Hub.

2



Nell'app Sure Petcare, seleziona **"Aggiungi dispositivo"**.

3



L'Hub entrerà in modalità di connessione e le orecchie lampeggeranno in verde.

4

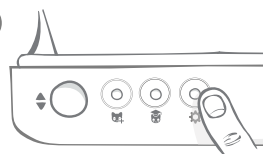

Premi una volta il pulsante per le impostazioni "⚙️" che trovi sul distributore. I LED nelle orecchie si illumineranno in verde.

5

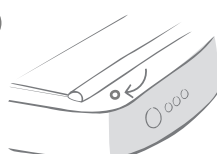

Completata la connessione con il distributore, i LED si spengono e smettono di lampeggiare.

i

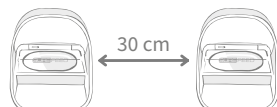

Puoi utilizzare l'app per connettere più distributori.

Come aggiungere un distributore alla rete domestica in uso



Puoi aggiungere un Distributore di cibo con lettore di microchip Connect alla rete domestica Sure Petcare esistente tramite l'app. Vai nella sezione Rete domestica e segui le istruzioni sopra indicate.

Puoi anche inserire l'ID microchip del tuo animale in remoto tramite l'app senza doverlo aggiungere manualmente. Tuttavia, aggiungere altri animali mettendo qualche crocchetta nella ciotola può incoraggiarli a utilizzare il nuovo dispositivo. **Consulta la pagina 155** per ulteriori informazioni su come aggiungere altri animali.



Pulsanti e luci

Pulsanti

Dietro al distributore di cibo puoi trovare 5 pulsanti:

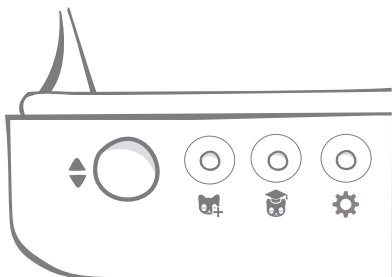

Pulsante Apri/Chiudi - Consente di aprire e chiudere il coperchio di accesso alle ciotole.



Pulsante Aggiungi un animale - Consente di inserire l'ID del microchip dell'animale da aggiungere al distributore (**vedi pagina 155**).



Pulsante Modalità addestramento - Consente di attivare la modalità addestramento che insegna all'animale a utilizzare il distributore (**vedi pagina 159-160**).



Pulsante Impostazioni - Consente di connettere il distributore e l'Hub (**vedi pagina 152**).



Pulsante di azzeramento - Consente di calibrare il distributore e impostare la corretta quantità di cibo da versare (**vedi pagina 157**). Questo pulsante azzerava **entrambi i bracci di pesatura del distributore, sia che si utilizzi la ciotola singola, sia le mezze ciotole.**



Quando utilizzi le **mezze ciotole**, se vuoi azzerare i singoli bracci, puoi farlo tramite l'**app Sure Petcare**.

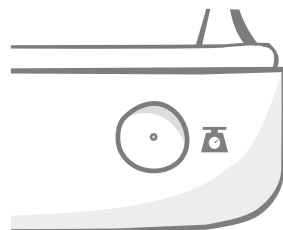

Blocco del coperchio



Bloccato - Quando il coperchio è sollevato, non puoi rimuoverlo.



Sbloccato - Quando il coperchio è sollevato, puoi rimuoverlo.

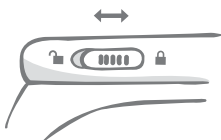

Il coperchio deve **rimanere sempre bloccato** ed essere sbloccato solo quando devi toglierlo per pulirlo. In questo modo, gli animali non autorizzati particolarmente astuti potranno solo tentare di rimuovere il coperchio per accedere al cibo, senza però riuscirci. **Considera comunque che ciò non impedisce l'apertura del coperchio.**

LED posteriore

Luce verde fissa. La luce verde si accende ogni volta che un animale autorizzato mangia dal distributore.

Luce verde lampeggiante. Il distributore è in modalità "Aggiungi un animale" (**vedi pagina 155**). La luce continuerà a lampeggiare fino a quando non viene aggiunto un microchip o non si esce dalla modalità.

Luce arancione lampeggiante. Il distributore è in modalità addestramento (**vedi pagina 159-160**). Il numero di volte in cui lampeggia si riferisce al livello di addestramento.

Luce rossa lampeggiante. Le batterie si stanno scaricando.

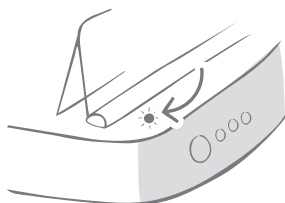

Luci delle porzioni

Se hai impostato un peso porzione nell'app Sure Petcare, le luci sulla parte anteriore del distributore fungeranno da guida durante l'aggiunta di cibo.

Le luci delle porzioni corrispondono alla quantità di cibo che aggiungi fino ad arrivare alla porzione corretta.

Per ulteriori informazioni sui vantaggi derivanti da una corretta porzionatura dei pasti, **consulta la pagina 156**.

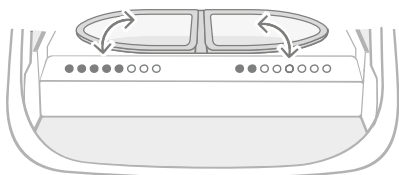
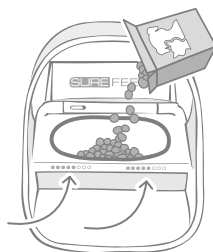

Utilizzo delle mezze ciotole

Le luci a destra corrispondono alla ciotola destra e quelle a sinistra alla ciotola sinistra. Le luci si accendono man mano che aggiungi il cibo in ciascuna ciotola.

Utilizzo della ciotola singola

Quando utilizzi la ciotola singola, le luci di entrambe le ciotole si accendono contemporaneamente.

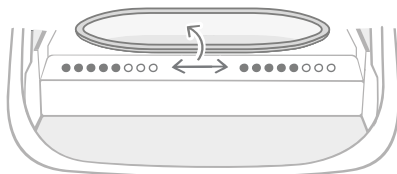

Se vuoi passare dalle mezze ciotole alla ciotola singola o viceversa, devi apportare la modifica tramite l'app Sure Petcare.



Se non imposti il peso della porzione nell'app, le luci non si accendono quando aggiungi il cibo.



Come aggiungere il tuo animale al distributore

Quando aggiungi l'ID microchip del tuo animale nel Distributore di cibo con lettore di microchip Connect, assicurati che tutti gli altri animali e le targhette da collare non autorizzati non si trovino nei pressi del dispositivo.

1

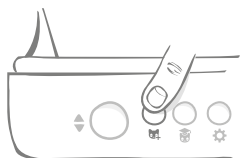

Premi il pulsante "Aggiungi un animale" (🐱) sul retro del distributore.

2

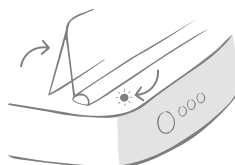

Il coperchio si apre e il LED posteriore lampeggia in verde una volta al secondo.

3

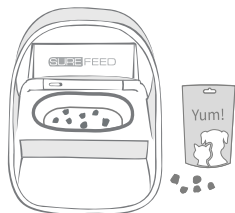

Metti un po' di cibo umido o secco nella ciotola e posiziona il distributore dove è abituato a mangiare il tuo animale.

4



Mentre mangia, il distributore esegue la scansione dell'ID del microchip. Una volta aggiunto l'ID, **la luce smette di lampeggiare** (ma rimane accesa).

5

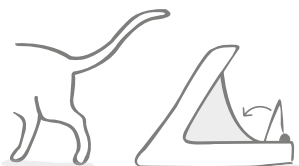

Quando l'animale si allontana, il coperchio si chiude e la luce verde si spegne. L'ID del microchip è ora memorizzato in modo permanente.

i



Se necessario, puoi annullare la modalità "Aggiungi un animale" in qualsiasi momento premendo di nuovo il pulsante (🐱).



Per programmare l'ID di un microchip, è necessario che i sensori situati nel telaio del distributore rilevino la presenza dell'animale. È quindi importante che il tuo animale entri nello spazio formato dal telaio per mangiare.



Per programmare una Targhetta per collare RFID Sure Petcare, segui semplicemente i passaggi precedenti ma tieni la targhetta all'interno del telaio. Assicurati di non indossare gioielli in metallo durante la programmazione di una targhetta.



Se hai già un animale registrato nella tua rete domestica Sure Petcare, puoi assegnarlo al distributore. Vai alla sezione Rete domestica dell'app. Se hai aggiunto l'animale sbagliato per errore, puoi sempre modificare la tua scelta da qui.



Come impostare le porzioni

Il Distributore di cibo con lettore di microchip Connect non solo controlla quando e cosa ha mangiato il tuo animale, ma può anche aiutarti a gestire accuratamente le porzioni ad ogni pasto.

Perché dovresti porzionare il cibo del tuo animale?

Pensi che il tuo animale sia un po' in sovrappeso? Impostando il peso delle porzioni puoi essere certo di non superare la dose consigliata. Ed ecco fatto!

La funzione di pesatura delle porzioni nel distributore garantisce al tuo animale di mangiare la giusta quantità di cibo in modo più semplice, veloce e conveniente.

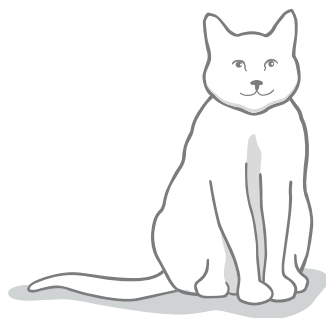

Quanto dovrebbe mangiare il tuo animale?

Sapere la giusta quantità di cibo da dare al tuo animale non è sempre facile, soprattutto quando c'è così tanta scelta. Ti consigliamo quindi di consultare il veterinario o un esperto di salute animale.

In alternativa, segui le linee guida fornite sulla confezione. Queste informazioni sono di norma attendibili quando si tratta di animali in salute.

Come impostare il peso delle singole porzioni nell'app

Puoi impostare il peso di ogni porzione direttamente nell'app Sure Petcare. Al termine della procedura, il valore viene inviato al distributore, in modo che apprenda la quantità di cibo per ogni porzione.

Le luci delle porzioni ti guidano durante l'aggiunta del cibo per garantirti di ottenere la porzione corretta. Le luci indicano la quantità di cibo aggiunto, **vedi pagina 158** per ulteriori informazioni.





Come aggiungere e sostituire il cibo

È importante sostituire quotidianamente il cibo del tuo animale, non solo per garantire il suo benessere, ma anche per mantenere il distributore pulito e funzionante.



1
Premi il pulsante
Apri/Chiudi (↕).

6
Quando tutte le luci lampeggiano in verde,
hai riempito le ciotole con l'intera porzione.

2
Togli le ciotole sporche e rimuovi
eventuali residui di cibo. Puliscile
o sostitiscile con quelle pulite.

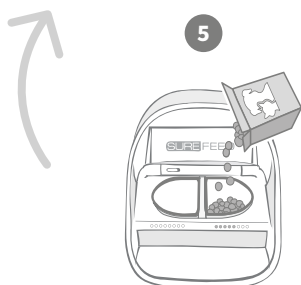

5
Dopo la sequenza di azzeramento, inizia
a riempire le ciotole. Le luci si accendono
per indicarti la quantità di cibo in ogni
ciotola - vedi la pagina successiva.

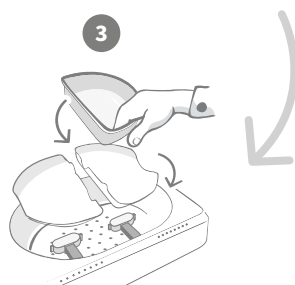

3
Accertati che gli appositi supporti per la
ciotola singola o le mezze ciotole siano
posizionati correttamente sui bracci di
pesatura e **appoggiaci sopra una ciotola**.

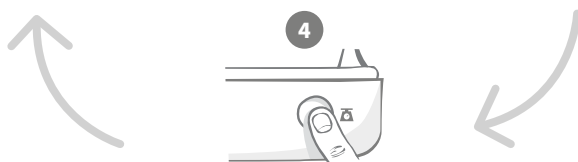

4
Prima di riempire le ciotole please put it in bold,
per assicurarti di dare una porzione completa al tuo animale.
Premendo questo pulsante si azzerano **entrambi i bracci di
pesatura del distributore (vedi pagina 153)**.

Luci delle porzioni



Sequenza di azzeramento

Le luci verdi si spengono da destra verso sinistra quando si preme il pulsante di azzeramento.



Aggiunta di cibo

Man mano che si aggiunge del cibo, le luci di porzionatura si accendono in verde, aumentando da sinistra a destra. Le luci accese corrispondono alla quantità di cibo nella ciotola. Continua ad aggiungere cibo finché tutte le luci non lampeggiano.



Raggiungimento del peso della porzione

Quando manca circa 1 grammo al peso indicato per la porzione, le luci **lampeggiano in verde**. Se le luci non lampeggiano, non è stata raggiunta la giusta quantità.



Quantità eccessiva

Se metti troppo cibo nella ciotola, le **luci rosse** ti avvisano di quanto hai esagerato. Togli la quantità di cibo sufficiente a far lampeggiare nuovamente di verde le luci.



Se continui senza aver impostato il peso della porzione nell'app, le luci della porzione **non si accendono** quando aggiungi il cibo nel distributore.

È rimasto del cibo nella ciotola?

Se c'è ancora del cibo nella ciotola quando è ormai ora di cena, non è necessario premere il pulsante di azzeramento. Sarà sufficiente mettere altro cibo nel distributore per consentirgli di aggiungere una nuova porzione al cibo rimasto. Le luci della porzione ti consentono di aggiungere la giusta quantità.

1

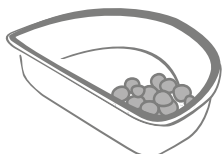

Quando apri il coperchio, alcune luci lampeggiano brevemente per indicare che nel distributore è rimasto del cibo nella ciotola. Tutte le luci si spengono per consentirti di aggiungere una nuova porzione al cibo rimanente.

2

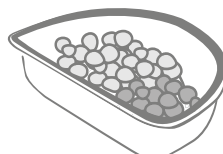

Riempi la ciotola finché tutte le spie non lampeggiano in verde.



Modalità addestramento

(come insegnare al tuo animale a usare il distributore)



Quando il distributore viene aperto con l'apposito pulsante, la luce arancione di addestramento lampeggia in rosso a indicare che il pulsante Apri/Chiudi è stato premuto e ora il dispositivo è aperto. La luce di addestramento torna arancione quando premi nuovamente il pulsante Apri/Chiudi dopo aver aggiunto la porzione di cibo.

Se non premi il pulsante Apri/Chiudi, le luci non si accendono e il sistema non è in grado di individuare l'aggiunta di cibo.

FASE 1 - Mostrare il distributore all'animale

Alcuni animali potrebbero aver bisogno di un po' di tempo per abituarsi al distributore di cibo. La modalità di addestramento ti consente di introdurre gradualmente i movimenti del coperchio per consentire al tuo animale di prendere lentamente confidenza con la sua nuova ciotola. Questa fase può richiedere un po' di tempo ma sii paziente e non passare alla **FASE 2** finché il tuo animale non si sente a proprio agio.

1

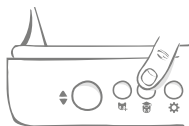

Con il coperchio chiuso, premi una volta il pulsante "Modalità addestramento" (🔴) sul retro del distributore. Il coperchio si apre e il LED posteriore lampeggia in arancione (una volta dopo qualche secondo).

2

Metti nella ciotola il cibo preferito del tuo animale e posiziona il dispositivo nel posto in cui mangia di solito o dove sai che si sente a proprio agio.

3



Durante questa prima fase di addestramento, **il coperchio rimane aperto** anche quando l'animale ha finito di mangiare.



Non avere fretta: lascia il tempo necessario al tuo animale per abituarsi alla sua nuova ciotola. Una volta che lo vedrai soddisfatto, passa alla FASE 2.

FASE 2 - Il movimento del coperchio è più rapido

Aumenta gradualmente il movimento del coperchio in tre fasi, per consentire al tuo animale di abituarsi piano piano. Ci teniamo a ricordarti che, per ottenere migliori risultati e fare in modo che il tuo animale sia felice, è importante essere pazienti e non forzare questa fase. Il tempo necessario per ogni fase cambia in base all'animale (giorni o settimane) ma raccomandiamo di dedicare qualche giorno a ogni fase.

4

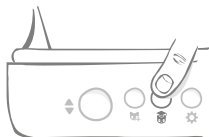

Inizia ad aumentare il movimento del coperchio premendo nuovamente il pulsante "Modalità addestramento" (🔴). Il coperchio si chiude un po' e la luce posteriore lampeggia due volte in arancione.

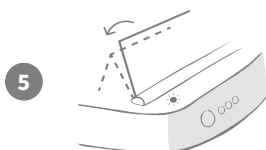

5

A questo punto, mentre il tuo animale mangia dalla ciotola, il coperchio, lentamente, si apre del tutto. Quando finisce di mangiare, il coperchio si chiude leggermente.



6

Concedi al tuo animale il tempo di abituarsi al nuovo movimento del coperchio. Quando è necessario sostituire il cibo, fallo normalmente (**vedi pagina 157**). Dopo aver sostituito il cibo, assicurati di premere il pulsante Apri/Chiudi (◈) per chiudere il coperchio in posizione di addestramento.



Ricordati di non avere fretta e di non passare alla fase successiva finché il tuo animale non si sente a proprio agio con questi movimenti del coperchio.

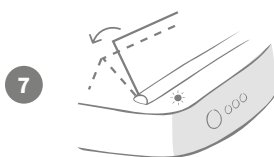

7

Quando l'animale si abitua a questi movimenti, premi nuovamente il pulsante "Modalità addestramento" (◻). Il coperchio si chiude un po' di più e la luce posteriore lampeggia 3 volte in arancione.



Continua a utilizzare il distributore normalmente e non passare alla fase successiva fino a quando l'animale non si abitua a questo movimento.

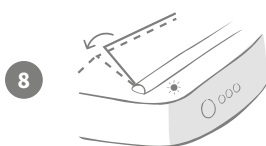

8

Il tuo animale ora dovrebbe conoscere bene il movimento del coperchio, quindi la fase finale di addestramento prevede che il coperchio si chiuda ancora di più. Come in precedenza, premi di nuovo il pulsante "Modalità addestramento" (○). Il coperchio raggiunge la posizione finale di chiusura e la luce posteriore lampeggia 4 volte in arancione.



9

Quando il tuo animale domestico si è abituato, premi di nuovo (○). Il coperchio si chiude completamente e la luce posteriore non lampeggia più. Il distributore è ora completamente chiuso e in modalità di utilizzo quotidiano.



Puoi terminare la modalità addestramento in qualsiasi momento tenendo premuto l'apposito pulsante (○) per **5 secondi**.



Per tornare al passaggio precedente, segui il suggerimento sopra indicato per uscire dalla modalità addestramento e riavviare la procedura.



Se il tuo animale non gradisce la chiusura del coperchio dopo aver mangiato, dall'app Sure Petcare puoi decidere di aumentare l'intervallo per la chiusura del coperchio.



Pulizia e manutenzione

È importante mantenere il Distributore di cibo con lettore di microchip Connect pulito per garantire che funzioni correttamente.

NON immergere il dispositivo completo nell'acqua o posizionarlo sotto un getto d'acqua corrente. L'acqua può causare danni al distributore e ai suoi componenti elettronici.

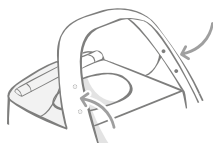
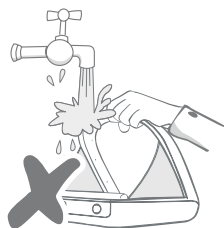

Assicurati che i quattro sensori sul telaio siano sempre puliti. Puoi pulire il tappetino con un panno umido. **Non mettere nessuno dei componenti in lavastoviglie ma lavi esclusivamente a mano.**

Alla base del Distributore di cibo con lettore di microchip Connect troverai un **vano di accesso con coperchio** per consentirti di pulire più facilmente e rimuovere eventuali briciole o residui di cibo.

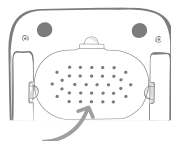

Come rimuovere il coperchio per la pulizia

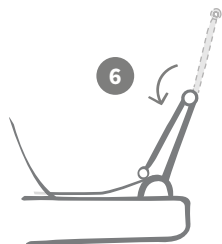

Ora alza la metà superiore del coperchio affinché poggi sulle guide del coperchio.

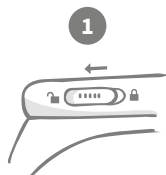

Sposta il selettore di blocco del coperchio in posizione di sblocco.

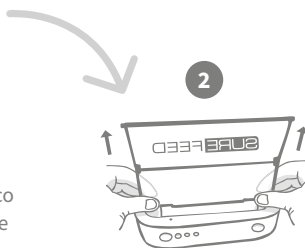

Premi il pulsante (◆). Una volta aperto il coperchio, tiralo verso l'alto.

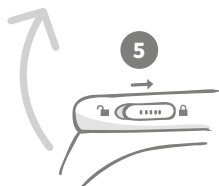

Riposiziona il selettore di blocco del coperchio in posizione di blocco.

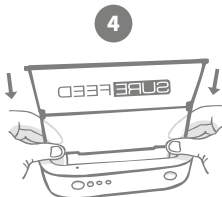

Al termine della pulizia, riposiziona il coperchio mantenendo le due metà in verticale e assicurati che sia correttamente inserito.

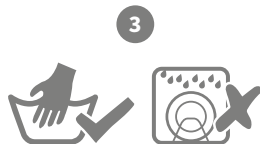

Lava esclusivamente a mano. **Non** mettere in lavastoviglie.

Come assicurarsi che il distributore sia pulito



1
Premi il pulsante Apri/Chiudi (◀▶).

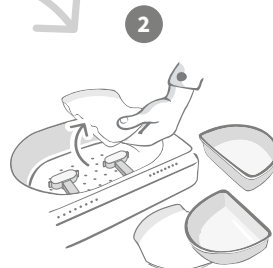

2
Rimuovi le ciotole, i supporti delle ciotole e il coperchio (vedi pagina precedente).



7
Rimonta tutti i componenti, facendo attenzione a **inserire per primo il coperchio del vano per la pulizia**.

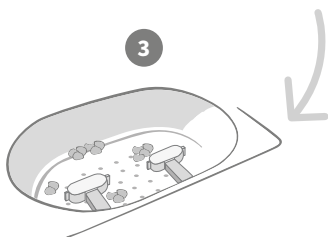

3
Eventuali residui di cibo presenti sui bracci di pesatura possono influire sulle prestazioni del distributore, quindi è molto importante mantenerli puliti. **Non utilizzare spugne abrasive** poiché potrebbero danneggiare il distributore e impedirne il corretto funzionamento.

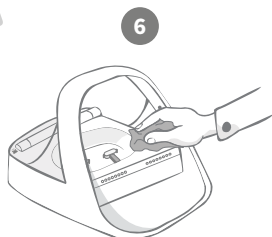

6
Utilizza un panno umido e assicurati che tutte le superfici del distributore siano pulite. **Non utilizzare detergenti abrasivi.**

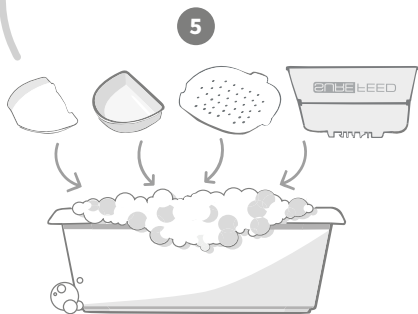

5
Lava a mano tutte le parti rimovibili.
Non metterle in lavastoviglie.

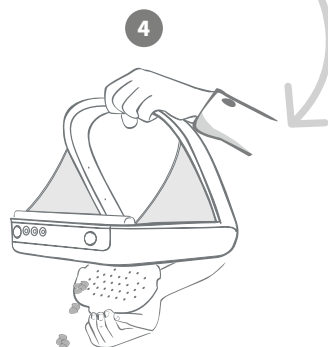

4
Svuota il distributore rimuovendo il coperchio di accesso per la pulizia e getta i residui di cibo nei rifiuti.



Impostazioni personalizzate

Sappiamo bene che non tutti gli animali si comportano allo stesso modo, ed è per questo che abbiamo progettato il Distributore di cibo con lettore di microchip Connect. Il distributore può infatti essere personalizzato tramite diverse impostazioni, progettate apposta per soddisfare le esigenze più inconsuete e inaspettate. Di seguito puoi trovare alcuni comportamenti particolari che le impostazioni personalizzate potrebbero aiutarti a risolvere.

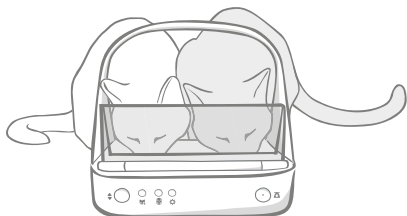

Un animale non autorizzato cerca di mangiare insieme a quello autorizzato?

Abbiamo l'impostazione giusta per te!

All'animale non autorizzato piace rubare il cibo dal distributore di un altro animale mentre è in modalità addestramento?

Abbiamo l'impostazione giusta per te!

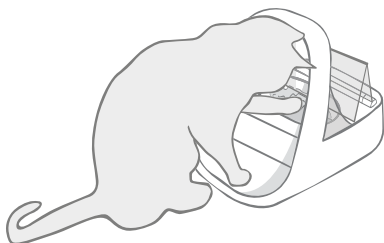
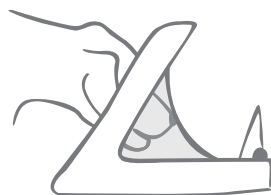

Il tuo animale non autorizzato ha capito come impedire la chiusura del coperchio?

Abbiamo l'impostazione giusta per te!

Il tuo animale non autorizzato cerca di rubare il cibo dalla parte posteriore del distributore?

Abbiamo l'accessorio giusto!

Vai alla pagina [surepetcare.com/accessories](https://www.surepetcare.com/accessories) e cerca la copertura posteriore.

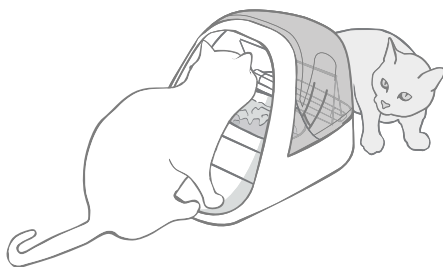

Per maggiori informazioni sulle impostazioni personalizzate, contatta il nostro team di assistenza clienti (**vedi l'interno di copertina per maggiori dettagli**). Il team saprà consigliarti l'impostazione personalizzata più appropriata per la tua situazione e configurarla per te da remoto.

L'Hub

Orecchie rosse lampeggianti

La connessione tra l'Hub e il Distributore di cibo con lettore di microchip Connect si è interrotta.

- Se **durante l'installazione entrambe le orecchie lampeggiano in rosso**, ti consigliamo di eseguire un ripristino delle impostazioni di fabbrica tenendo premuto il pulsante sulla base dell'Hub per 10 secondi.
- Se **entrambe le orecchie lampeggiano a lungo in rosso dopo l'installazione**, prova a spegnere e riaccendere l'Hub. Stacca la spina dalla presa di corrente, attendi 30 secondi e ripristina l'alimentazione. Se le orecchie diventano verdi per alcuni minuti, l'Hub si è ricollegato.
- Puoi anche provare a **riposizionare il tuo Hub** seguendo i consigli forniti a **pagina 149**. Se il problema persiste, avvicina l'Hub al distributore di cibo (prosegui la lettura).
- Per avvicinare l'Hub, prova a collegarlo al router utilizzando un cavo Ethernet più lungo.
- Se quanto sopra non dovesse funzionare, ti consigliamo di acquistare un "**Ethernet over power adapter**" che ti consentirà di utilizzare una normale presa di corrente per collegare l'Hub a Internet più vicino al distributore.

Orecchie lampeggianti in modo alternato (rosse o verdi)

Il tuo Hub ha problemi di connessione ai server Sure Petcare. Potrebbe essere dovuto a una connessione Internet non affidabile.

- Prova a spegnere e riaccendere l'Hub, staccando la presa dalla corrente e riattaccandola dopo 30 secondi. Se le orecchie diventano verdi per alcuni minuti, l'Hub si è ricollegato.
- Se quanto sopra descritto non dovesse funzionare, assicurati che il tuo router Internet sia acceso e che la tua connessione Internet funzioni correttamente con altri dispositivi.
- Se non funziona con altri dispositivi, prova a spegnere il router e a riaccenderlo dopo 30 secondi.
- Se il router funziona con altri dispositivi, prova a ricollegare il cavo Ethernet al router e all'Hub. Assicurati che sia correttamente inserito, poiché a volte può sembrare ben collegato anche quando non lo è.

Se continui a riscontrare problemi di connettività, visita la pagina surepetcare.com/hub-connectivity

Orecchie rosse fisse

L'Hub sta aggiornando il firmware. Attendi qualche minuto finché le orecchie dell'Hub non diventano verdi. Non dovrebbe metterci più di 2 minuti. Una volta completato l'aggiornamento del firmware, dovrai riavviare l'Hub. A questo punto vedrai la sequenza di luci di installazione (**vedi pagina 150**).

Notifiche rallentate

Se dovessi notare un rallentamento nelle notifiche nell'app, è probabile che l'Hub stia cercando di connettersi al Distributore di cibo con lettore di microchip Connect. Per ottimizzare la velocità dei messaggi, prova a spostare l'Hub in una posizione migliore seguendo i consigli forniti a **pagina 149**.

Distributore di cibo con lettore di microchip Connect

Se dovessi riscontrare problemi di natura meccanica con il tuo distributore, non provare a risolverli da solo, ma contatta il nostro servizio clienti sempre a tua disposizione. Per i contatti vedi **l'interno di copertina**.

Il distributore non si apre per l'animale che ho autorizzato

- Accertati che i 4 sensori all'interno del telaio siano puliti (**vedi pagina 161**).
- Verificare di aver inserito batterie **alcaline** di buona qualità e che non si stiano esaurendo. Accertati che i poli + e - corrispondano correttamente (**vedi pagina 151**).
- Allontana il distributore da qualsiasi apparecchio metallico o elettrico. Se il distributore non si apre ancora per l'animale autorizzato, continua a leggere.
- Verifica che non vi siano fonti evidenti di interferenze elettriche nelle vicinanze, ad esempio luci tremolanti difettose, ecc. Se sospetti che ci siano, contatta il nostro team di assistenza clienti (**vedi l'interno di copertina per maggiori dettagli**).
- Se quanto sopra non funziona, verifica con il veterinario che il microchip del tuo animale funzioni e che si trovi nella corretta posizione. Se dovesse essersi spostato molto, sarà difficile farlo riconoscere dal dispositivo. Nel frattempo puoi utilizzare la Targhetta per collare RFID Sure Petcare in dotazione. Attacca la targhetta al collare del tuo animale e ripeti la procedura di aggiunta di un animale (**vedi le pagine 155**).

Al mio animale non piace usare il distributore di cibo

- Ripeti la procedura di addestramento lasciando più tempo al tuo animale per prendere confidenza con il dispositivo tra una fase e l'altra (**vedi pagina 159-160**).
- Se il tuo animale domestico è ancora molto sospettoso nei confronti del distributore, prova a seguire i passaggi consigliati su [surepetcare.com/cautiouspet](https://www.surepetcare.com/cautiouspet) senza comunque forzarlo a mangiare.
- Valuta l'ambiente in cui solitamente il tuo animale mangia. Si avvicina alla ciotola sempre dalla stessa parte? Dare le spalle alla porta lo preoccupa? Non esiste un orientamento prestabilito in cui posizionare il distributore, quindi, se puoi, cambialo in base alle esigenze del tuo animale.
- Se il tempo della chiusura ritardata del coperchio (dopo che il tuo animale ha finito di mangiare e ha fatto un passo indietro) non è giusto per lui, puoi aumentarlo o diminuirlo tramite l'app Sure Petcare.

Il coperchio del distributore non si chiude completamente

- Potrebbe essere causato da residui di cibo rimasti sotto il coperchio o nel meccanismo di chiusura. Per assicurarti che il coperchio continui a chiudersi correttamente, è importante rimuovere i residui di cibo dalle superfici del distributore (**vedi pagina 161-162**).
- Assicurati che la modalità addestramento non sia attivata, **visita la pagina 159** per saperne di più sul funzionamento della modalità di addestramento.

Le luci della porzione sono accese ma la ciotola è vuota

Se quando apri il distributore alcune luci della porzione sono verdi anche se non c'è cibo nelle ciotole, dovrai azzerare i bracci di pesatura. Per risolvere il problema, assicurati di premere sempre il pulsante di azzeramento prima di sostituire il cibo (**vedi pagina 157-158**).

Le luci della porzione non si accendono

- Se non hai impostato il peso della porzione dall'app Sure Petcare, le luci della porzione non si accendono quando aggiungi il cibo nel distributore.
- Inoltre, i residui di cibo sui bracci di pesatura possono influire sulle prestazioni del distributore, quindi assicurati di tenere sempre pulita questa zona (**vedi pagina 161-162**).

Altri animali non autorizzati rubano il cibo dal distributore

- Se animali non autorizzati e molto golosi cercano di rubare il cibo da un distributore aperto, puoi provare a ridurre il tempo di chiusura del coperchio tramite l'app Sure Petcare.
- Potrebbe esserci un'impostazione personalizzata che può aiutarti a risolvere il problema. Per maggiori informazioni contatta il nostro team di assistenza clienti (**vedi l'interno di copertina per maggiori dettagli**).
- In alternativa, se altri animali non autorizzati riescono comunque a rubare il cibo dal retro o dal lato del distributore quando il coperchio è aperto e l'animale autorizzato sta mangiando, abbiamo creato una copertura posteriore che dovrebbe risolvere il problema. Per ulteriori informazioni, visita la pagina **surepetcare.com/accessories**.

Ridotta autonomia della batteria

- Assicurati che il distributore sia pulito e che i sensori siano puliti (**vedi pagina 161**).
- Assicurati di aver inserito batterie di buona qualità e che siano state montate correttamente (**vedi pagina 151**).
- Verifica che non vi siano fonti evidenti di interferenze elettriche nelle vicinanze, ad esempio luci tremolanti difettose, ecc. Se sospetti che ci siano, contatta il nostro team di assistenza clienti. Vedi l'**interno di copertina** per i dettagli.

Più distributori sulla stessa rete domestica

- Se ti accorgi che tu o i tuoi animali vi confondete fra i distributori, prova a utilizzare ciotole di colore diverso o a spostarli in posizioni differenti. Dovrebbe aiutarti. Ciotole di colori diversi e tappetini sono venduti separatamente. Per ulteriori informazioni, visita la pagina **surepetcare.com/accessories**.

Hai ancora bisogno di assistenza?



- Se continui a riscontrare problemi di connettività, visita la pagina **surepetcare.com/hub-connectivity**
- Per ulteriori indicazioni, video e forum di assistenza ai clienti visita la pagina **surepetcare.com/support**
- In caso di problemi con l'app Sure Petcare, visita: **surepetcare.com/apphelp**

Oppure contatta il nostro team di assistenza clienti sempre a disposizione.

Vedi l'interno di copertina per maggiori dettagli.



Garanzia e dichiarazione di non responsabilità

Garanzia. Il Distributore di cibo con lettore di microchip Connect SureFeed è coperto da una garanzia di 3 anni a partire dalla data di acquisto, previa prova della data di acquisto. La garanzia è limitata a qualsiasi difetto causato da materiali, componenti o fabbricazione difettosi. La presente garanzia non si applica ai prodotti il cui difetto è stato causato da normale usura, uso improprio, negligenza o danno intenzionale. In caso di guasto di un componente a causa di parti o lavorazione difettose, il componente sarà sostituito gratuitamente solo durante il periodo di garanzia. In caso di malfunzionamento più grave, un dispositivo sostitutivo può essere fornito gratuitamente a discrezione del produttore. I tuoi diritti legali non verranno pregiudicati.

Dichiarazione di non responsabilità. Il Distributore di cibo con lettore di microchip Connect e la relativa app registrano il consumo di cibo rilevando l'ID del microchip dell'animale domestico e misurando il peso della ciotola prima e dopo il pasto. Nella maggior parte dei casi verranno forniti dati affidabili sul consumo di cibo, tuttavia un uso imprevisto o anomalo del distributore (come, ad esempio l'animale che sposta la ciotola o gioca con il cibo) potrebbe inficiare i dati. Sure Petcare non può essere ritenuta responsabile per danni o disagi che potrebbero derivare da una registrazione errata del consumo di cibo.

Il Distributore di cibo con lettore di microchip Connect SureFeed dispone di funzioni integrate di accesso selettivo alle ciotole progettate per ridurre al minimo il rischio che gli animali si mangino il cibo a vicenda. Tuttavia, non è possibile garantire la totale esclusione di tutti gli altri animali in qualsiasi circostanza. Nel raro caso in cui un animale non autorizzato riesca ad accedere al distributore, Sure Petcare non può essere ritenuta responsabile per eventuali danni o disagi che potrebbero verificarsi.



Smaltimento di dispositivi e batterie usate: questo simbolo indica i dispositivi soggetti alla seguente legislazione:

La direttiva sui rifiuti di apparecchiature elettriche ed elettroniche 2012/19/UE (direttiva RAEE) e la direttiva 2006/66/CE sulle batterie (come indicato nell'emendamento 2013/56/UE) impongono l'obbligo di smaltire i rifiuti di batterie e prodotti giunti a fine del ciclo di vita in modo responsabile. Per ridurre l'impatto sull'ambiente, questi rifiuti non possono essere gettati nei cassonetti dei rifiuti domestici e devono essere riciclati in un apposito impianto di riciclaggio. Ulteriori informazioni sul riciclaggio sono disponibili all'indirizzo: www.recycle-more.co.uk.

Sostituire le batterie prima della data di scadenza indicata sulla confezione o sulle batterie stesse e smaltirle in modo sicuro e appropriato.

In caso di perdite, indossare indumenti protettivi adeguati per proteggersi da qualsiasi esposizione a sostanze chimiche nocive prima di smaltire le batterie e di pulire eventuali fuoriuscite. Durante la pulizia, evitare il contatto con la pelle. Non ingerire o toccarsi gli occhi con le mani sporche di prodotti chimici della batteria. Contattare immediatamente un medico se ciò dovesse accadere.

Marchi commerciali. Google Play e il logo Google Play sono marchi commerciali di Google Inc. Apple è un marchio di Apple Inc., registrato negli Stati Uniti e in altri Paesi. App Store è un marchio di servizio di Apple Inc., registrato negli Stati Uniti e in altri Paesi. iOS è un marchio o un marchio registrato di Cisco negli Stati Uniti e in altri Paesi ed è utilizzato su licenza.



SURETM
PETCARE

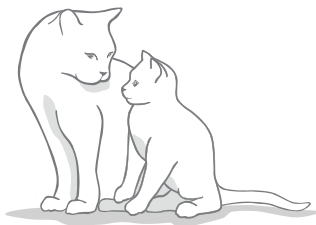

Obrigado por escolher o Microchip Pet Feeder Connect!

O sistema Microchip Pet Feeder Connect é constituído por três elementos que funcionam em conjunto para manter a ligação ao seu animal de estimação e fornecer informações sobre os hábitos de alimentação.

O **Microchip Pet Feeder Connect** é o componente principal do sistema. Reconhece a ID do microchip já implementada no seu animal de estimação ou a Etiqueta RFID de coleira Sure PetCare (uma incluída), permitindo ao seu animal aceder à comida e impedindo que outros animais o façam.

O **Hub** (vendido separadamente) é o elemento ligado do sistema. Liga à sua rede de Internet doméstica e pode comunicar com o Comedouro e com a aplicação Sure Petcare.

Ao utilizar a **aplicação Sure Petcare**, poderá monitorizar a quantidade de comida ingerida pelo seu animal de estimação e a frequência com que visita o Comedouro. A aplicação também lhe permite enviar o peso de uma porção para o Comedouro e controlar a quantidade de alimento por refeição.

Conteúdo da caixa

Certifique-se de que recebeu todos os itens seguintes*

- 1 1 x Microchip Pet Feeder Connect
- 2 1 x Tigela única
- 3 2 x Meias tijelas
- 4 1 x Tapete
- 5 1 x Suporte de tigela única
- 6 2 x Suportes de meia tijela
- 7 1 x Etiqueta RFID de coleira Sure Petcare

*As pilhas e o Hub não estão incluídos

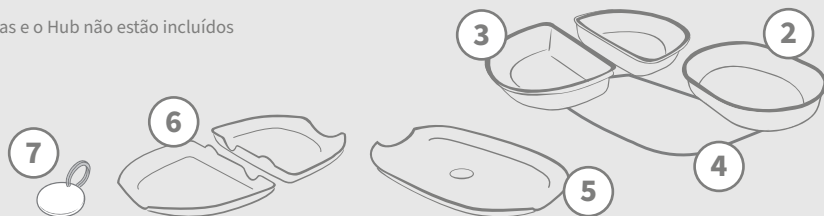
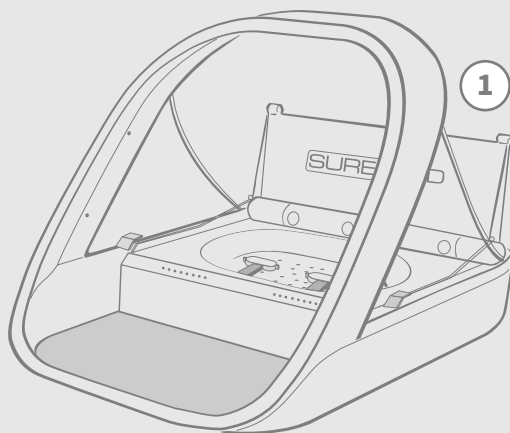

Para que o Microchip Pet Feeder Connect funcione como um sistema ligado, será necessário comprar um Hub correspondente. Para obter mais informações sobre como comprar um HUB, visite surepetcare.com/hub.

Índice

Informações importantes	172
Descrição do produto.....	174
Sistema Microchip Pet Feeder Connect.....	176
Hub	
Configurar o seu Hub	177
Onde instalar o seu Hub.....	178
Luzes do Hub	179
Comedouro	
Pilhas	180
Ligar o seu Comedouro.....	181
Botões e luzes.....	182
Adicionar o seu animal ao Comedouro.....	184
Configurar porções	185
Adicionar e substituir a comida.....	186
Modo de treino	188
Limpeza e manutenção	190
Ajuda e suporte	192
Garantia e isenção de responsabilidade	196

i

Informações importantes



LEIA CUIDADOSAMENTE AS INFORMAÇÕES SEGUINTE E CONSERVE ESTE MANUAL PARA FUTURA REFERÊNCIA.



Este produto destina-se **apenas a animais domésticos.**



Utilize apenas acessórios SureFeed para garantir a compatibilidade: surepetcare.com/accessories



Certifique-se de que recebeu todos os itens indicados na **página 169.**



Não coloque o Comedouro em áreas muito frequentadas por pessoas.



O Comedouro destina-se **apenas a uso no interior.**



Não submerja o Comedouro em água nem o coloque debaixo de água corrente.



Não coloque o Comedouro no frigorífico nem coloque sacos de gelo debaixo ou no seu interior.



Não coloque o Comedouro num local exposto a calor excessivo.



Este produto requer **4 x pilhas C/LR14** que deve instalar e substituir com cuidado. Não misture tipos de pilhas diferentes nem misture pilhas novas e usadas. Se guardar o Comedouro durante longos períodos de tempo sem utilização, retire as pilhas.

Podem encontrar o **código do produto** e o **número de série** do Microchip Pet Feeder Connect na parte inferior do produto.

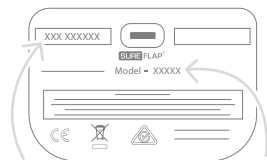

N.º de série Código do produto

Avisos de segurança

- **Não** utilize este produto se faltarem peças ou estiverem danificadas ou desgastadas.
- **Existem componentes pequenos usados na construção deste item.** Quaisquer peças soltas devem ser mantidas afastadas das crianças e animais de estimação para **evitar o risco de asfixia.**

Outros aspetos importantes a considerar



ANIMAIS: A Sure Petcare recomenda que o SureFeed Microchip Pet Feeder Connect seja utilizado com o microchip implantado no seu animal de estimação, no entanto pode também ser operado com a Etiqueta RFID de coleira Sure Petcare. Se utilizar uma etiqueta de coleira, deve ser utilizada com uma coleira de segurança que **inclua uma fivela de separação** (apenas gatos). A Sure Petcare declina qualquer responsabilidade por quaisquer danos ou morte causadas pela coleira de um animal.



ACESSO À COMIDA: A Sure Petcare declina qualquer responsabilidade por qualquer acesso obtido por um animal não autorizado devido à incorreta utilização do produto. Como proprietário deste produto, **aceita toda a responsabilidade por supervisionar a administração de comida** que possa provocar danos a outros animais se consumida involuntariamente.



FUNÇÃO SEM TEMPORIZADOR: Este produto não contém um temporizador **nem nenhuma funcionalidade temporizada**. Por este motivo, não deixe o seu animal de estimação sem monitorização nem confie neste produto para alimentá-lo durante longos períodos de tempo - não mais de 24 horas para um gato, ou a duração de tempo média entre refeições para um cão de pequeno porte. **Este produto não é um substituto para a posse responsável de um animal de estimação.**



CRIANÇAS: **Não deve permitir que as crianças brinquem com o SureFeed Microchip Pet Feeder Connect.** Não é um brinquedo e não deve ser tratado como tal. No entanto, este produto pode ser utilizado por crianças com mais de 8 anos e por pessoas com capacidades físicas, sensoriais ou mentais reduzidas desde que sejam supervisionadas ou recebam instruções sobre a utilização segura do produto. Devem ser sempre informadas sobre os potenciais riscos envolvidos. Não permita que crianças de qualquer idade limpem o produto sem supervisão.



PROTEÇÃO DE CRIANÇAS: Nos lares com crianças, é essencial **incluir o SureFeed Microchip Pet Feeder Connect nas considerações de proteção de crianças.** A utilização incorreta deste produto por uma criança pode resultar em riscos potenciais para a criança. Por este motivo, as crianças devem ser sempre monitorizadas quando estiverem próximas do Comedouro. Tenha em atenção que quando o Comedouro está em **modo de treino (consulte a página 187-188), uma criança pode aceder à comida do animal de estimação.**



Descrição do produto

O sistema Microchip Pet Feeder Connect é constituído por três componentes principais:

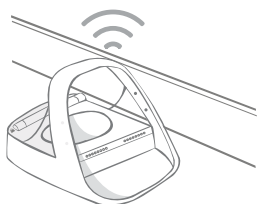

Microchip Pet Feeder Connect



Hub



Aplicação Sure PetCare

O Hub liga-se à Internet através de um cabo de Ethernet e monitoriza a atividade do Microchip Pet Feeder Connect. Comunica com o Comedouro e a aplicação Sure Petcare, permitindo-lhe ver atualizações na aplicação Sure Petcare mesmo quando não está em casa!

Pode também configurar o peso de porção na aplicação. Após configurar, o Comedouro orienta-o à medida que adiciona a comida para garantir que o seu animal recebe a quantidade correta de comida. Para obter mais informações, **consulte a página 182**.

Sensores: São utilizados quatro pequenos pontos no interior do aro para detetar o animal de estimação.

Tapete: Concebido para recolher resíduos de comida, tornando mais fácil limpar o Comedouro.

Luzes indicadoras de porção: consulte a página 182.

Tijelas e suportes de tijelas: consulte a página 174.

Bloqueio da tampa: consulte a página 181.

LED traseiro: consulte a página 182.

Botões: consulte a página 181.

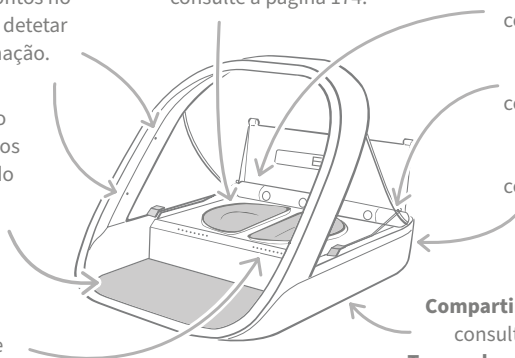

Compartimentos de pilhas: consulte a página 179.

Tampa de acesso para limpeza: consulte a página 189.

Luzes do Hub: consulte a página 178.

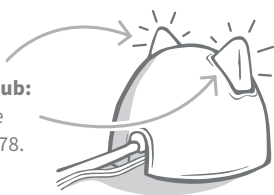

Porta de Ethernet: para ligar ao router de Internet.

Fonte de alimentação: para ligar o cabo de alimentação.

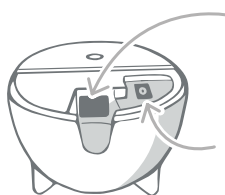

As tijelas SureFeed têm um vedante integrado na extremidade superior para ajudar a manter a frescura da comida do animal. Se alimentar o seu animal apenas com um tipo de comida, pode utilizar a tijela única, mas se lhe der comida seca e húmida, as meias tijelas são perfeitas.



Tijela única - pode conter 250 g, que é suficiente para duas bolsas de comida húmida.

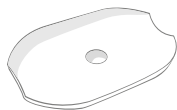

Suporte de tijela única - concebido para fixar a tijela única, (não as meias tijelas).

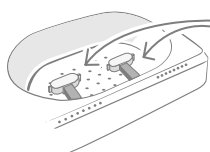

Braços de pesagem - concebido para fixar o suporte da tijela.



Meias tijelas - cada tijela contém até 100 g ou 200 g no total.



Suportes de meia tijela - concebido para fixar a meia tijela, (não a tijela única).

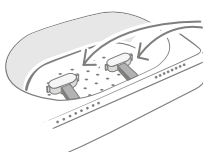

Braços de pesagem - concebido para fixar os suportes da tijela.

Não coloque a comida do animal diretamente sobre os suportes da tijela.

Utilize sempre as tijelas para garantir o funcionamento correto do Comedouro.



A meia tijela SureFeed não foi concebida para utilização com o Microchip Pet Feeder Connect.

Para comprar tijelas ou tapetes adicionais, consulte um fornecedor do Sure Petcare ou visite surepetcare.com.

Adicione cor



As tijelas de plástico e tapetes SureFeed estão disponíveis em diferentes cores: azul, verde, rosa e cinzento.

Ou adicione brilho

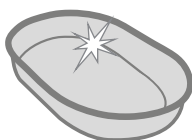

A tijela única SureFeed está também disponível em aço inoxidável.



Não coloque as tijelas na máquina de lavar louça nem no micro-ondas.



Lave as tijelas à mão antes da primeira utilização.



Sistema Microchip Pet Feeder Connect

Transfira a aplicação Sure PetCare agora

DESCARREGAR NA
APP STORE

DISPONÍVEL NO
GOOGLE PLAY

 surepetcare.io



Receba notificações quando o seu animal estiver a comer.



Monitore o consumo de alimentos do seu animal e perceba se há alterações de comportamento.



Dosifique a porção de forma precisa para controlar a quantidade por porção.



Partilhe o acesso ao seu agregado com família e amigos.



Transfira a **aplicação Sure PetCare** e crie uma conta. Será solicitado que crie um "agregado" (uma rede ligada que contém todos os seus produtos Sure Petcare ligados, e todos os seus animais). Pode convidar outros membros da sua família para aderirem ao seu agregado.

Para transferir a aplicação, o seu telefone ou tablet devem ter o **iOS 9 da Apple** ou **4.4 em Android**.



Se preferir controlar os seus produtos Sure Petcare ligados a partir do seu computador, pode utilizar a aplicação Web da Sure Petcare em **surepetcare.io**.

Necessita da versão mais recente do **Safari, Chrome, Firefox** ou **Internet Explorer** com **Mac OS X v10.9** ou posterior e **Windows 7** ou posterior.

Comprar um Hub Sure Petcare



Para que o Microchip Pet Feeder Connect funcione com a aplicação Sure Petcare, será necessário comprar um Hub correspondente. Para obter mais informações, visite **surepetcare.com/hub**.



Configurar o seu Hub

Após transferir a aplicação Sure Petcare, tem de ligar o Hub e configurá-lo. Após configurar o Hub, será solicitado que o ligue ao Comedouro e à aplicação. Siga os passos abaixo:

1

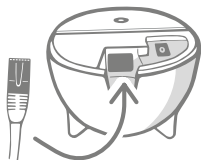

Ligue uma extremidade do cabo de Ethernet à base do Hub e a outra extremidade a uma porta Ethernet do router.

2

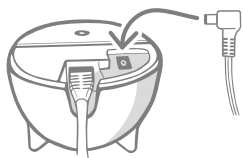

Monte a fonte de alimentação e ligue-a a uma tomada elétrica. Ligue a outra extremidade do cabo à base do Hub.

3

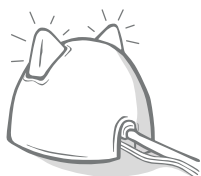

As "orelhas" do Hub **alternam entre vermelho e verde**. Quando ambas as orelhas ficarem fixas a verde, o Hub está pronto. Se as orelhas não seguirem esta sequência, **consulte a página 178** para obter mais informações.

4



Para concluir a configuração do sistema Microchip Pet Feeder Connect, será necessário **seguir os passos restantes na aplicação Sure Petcare**.



O Hub pode receber atualizações de software. Se vir **luzes vermelhas fixas** durante a configuração, não se preocupe, o Hub está a atualizar o software. Após concluir, o Hub será reiniciado e pode ver a sequência de luzes indicada no passo 3.



Onde instalar o seu Hub

Como o sistema Microchip Pet Feeder Connect utiliza uma comunicação sem fios, a localização do Hub pode afetar o desempenho.



Coloque o Hub, no mínimo, a 1 metro do chão (por exemplo, numa mesa sem obstruções).

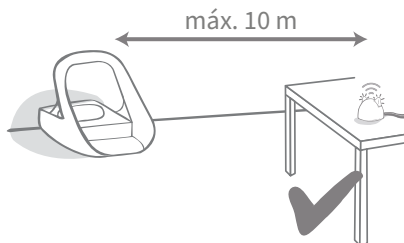

Tente colocar o Hub na linha de visão do Comedouro e a uma distância máxima de 10 metros.

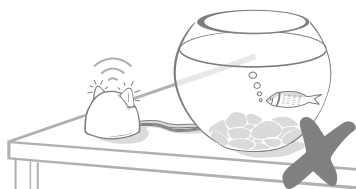

Evite colocar o Hub próximo ou na linha de visão de grandes volumes de água (por exemplo, aquários).

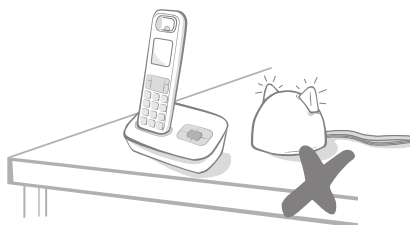

Mantenha o Hub à máxima distância possível de possíveis fontes de interferência (por exemplo, telefones sem fios, monitores de bebés, etc.).

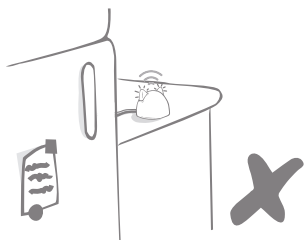

Certifique-se de que o Hub não está colocado próximo de grandes objetos de metal (por exemplo, o frigorífico).

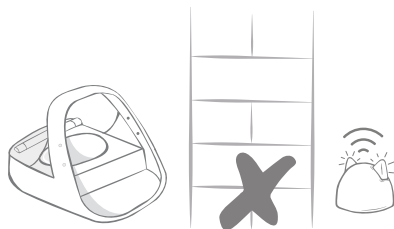

Evite paredes grossas entre o Hub e o Comedouro.



Ocasionalmente, o Hub pode sofrer problemas de ligação apesar de seguir estes conselhos. Para obter mais indicações sobre como aproximar o Hub do Microchip Pet Feeder Connect, aceda a surepetcare.com/hub-connectivity.



Se o Hub perder a ligação à Internet por qualquer motivo, o Microchip Pet Feeder Connect continuará a funcionar normalmente e manterá as definições.



Luzes do Hub

O Hub indica o estado atual com as luzes das orelhas. Cada sequência luminosa colorida tem um significado diferente.

Luzes de configuração

Sempre que liga o Hub ou tenta ligar a outros elementos do sistema, pode ver as luzes de configuração:

- 1** as orelhas **alternam a vermelho** durante algum tempo,

- 2** e, em seguida, **alternam a verde**,

- 3** quando vir uma luz **laranja intermitente** e as orelhas ficarem **verde fixo**, o Hub está ligado.



Orelhas verdes

As orelhas verdes significam que o Hub está a funcionar corretamente. Consulte abaixo para ver detalhes sobre o significado de cada sequência luminosa.

Ambas as orelhas em verde fixo - O Hub está ligado, com ligação estabelecida e a funcionar corretamente.

Orelhas alternam a verde - O Hub está a restabelecer a ligação aos nossos servidores.

Orelhas vermelhas

Ambas as orelhas em vermelho fixo - O Hub está a atualizar o software. Seja paciente, o Hub será reiniciado e continuará a funcionar normalmente em breve.

Ambas as orelhas piscam a vermelho - O Hub perdeu a ligação com o Comedouro e está a tentar restabelecer a ligação.

Orelhas alternam a vermelho - O Hub está com dificuldade para estabelecer a ligação à Internet e/ou aos servidores.

i Para obter mais informações sobre como diagnosticar estes problemas, consulte a **página 192**.



Pilhas

Utilize sempre **4 x pilhas alcalinas modelo C/LR14 de 1,5 V**. Assim garantirá o melhor desempenho do seu Microchip Pet Feeder Connect. **Este produto NÃO se destina a utilização com pilhas recarregáveis.** Para inserir as pilhas, siga os passos abaixo:

i Há uma luz próximo da traseira do Comedouro. Se as pilhas estiverem fracas, ou se forem incorretamente inseridas, esta luz pisca a vermelho a cada 5 segundos.

1

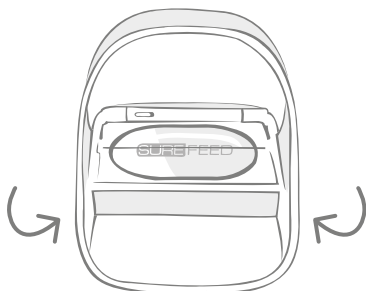

Inverta o Comedouro para aceder ao compartimento das pilhas.

2

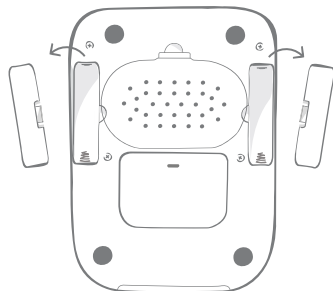

Remova as tampas das pilhas.

3

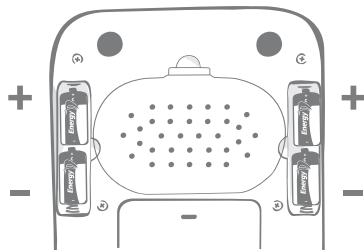

Insira as pilhas. Certifique-se de que os símbolos +/- das pilhas coincidem com os símbolos no Comedouro.

4

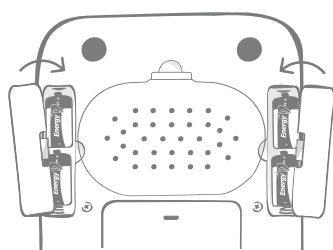

Coloque a tampa das pilhas.



Após programar a ID do microchip do seu animal de estimação no Comedouro, será guardada permanentemente na memória. Isto significa que, mesmo que substitua as pilhas, o Comedouro continuará a reconhecer o animal autorizado.



Ligar o seu Comedouro

Para concluir a configuração do sistema ligado, será necessário ligar o Comedouro ao seu Agregado.

1

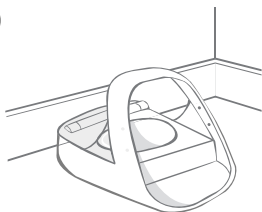

Coloque o Comedouro no local pretendido. Esta ação garante que o produto comunique com o Hub.

2



Na aplicação Sure PetCare, selecione **Adicionar produto**.

3



O Hub entra em modo de ligação e as orelhas piscam a verde.

4

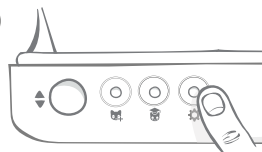

Prima uma vez o botão de definições  no Comedouro. O LED da orelha acende a verde.

5

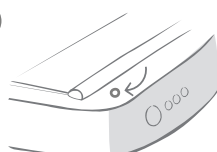

Após estabelecer ligação, o LED apaga-se e o Hub para de piscar.

i

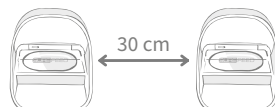

Se desejar ligar mais Comedouros, pode fazê-lo facilmente na aplicação.

Adicionar um Comedouro ao seu Agregado atual



Pode adicionar um Microchip Pet Feeder Connect ao seu Agregado atual Sure Petcare na aplicação. Aceda à secção Agregado e siga as instruções acima.

Pode também atribuir a ID do microchip do seu animal remotamente através da aplicação. Isto significa que não terá de adicioná-los manualmente. No entanto, a utilização de guloseimas para adicionar animais de estimação pode incentivá-los a usar o novo produto. **Consulte a página 183** para obter mais informações sobre como adicionar animais de estimação.



Botões e luzes

Botões

Existem 5 botões no Comedouro. Pode encontrá-los na parte traseira do produto:

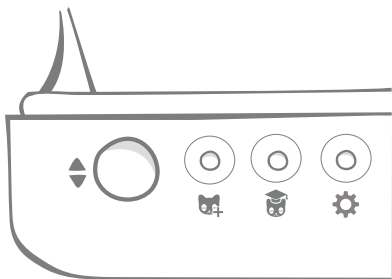

Botão Abrir/fechar - abre e fecha a tampa para aceder às tijelas.



Botão Adicionar um animal - utiliza-se para adicionar a ID do microchip do seu animal ao Comedouro - **consulte a página 183.**



Botão Modo de treino - utiliza-se para ativar o modo de treino e ensinar o seu animal a utilizar o Comedouro - **consulte a página 187-188.**



Botão Definições - utiliza-se para ligar o Comedouro e o Hub - **consulte a página 180.**



Botão Zero - utiliza-se para calibrar o Comedouro e garantir a quantidade correta de comida - **consulte a página 185.** Este botão repõe a zero **ambos os lados do Comedouro, quer esteja a utilizar uma tijela ou meias tijelas.**



Quando utiliza **meias tijelas**, pode repô-las a zero de forma individual utilizando a **aplicação Sure Petcare.**

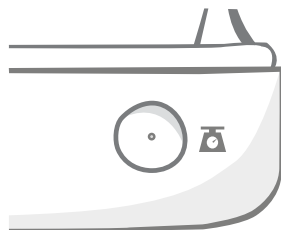

Bloqueio da tampa



Bloqueado - significa que não pode puxar e remover a tampa do Comedouro.



Desbloqueado - pode puxar a tampa quando está na posição aberta para a remover.

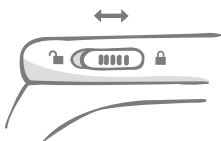

O bloqueio da tampa deve **permanecer bloqueado** e apenas deve ser desbloqueado para retirar e limpar a tampa. Serve para impedir que animais de estimação espertos não autorizados tentem remover a tampa para aceder à comida. **Tenha em atenção que não impede a abertura da tampa.**

LED traseiro

Luz verde fixa. A luz verde acende-se sempre que um animal autorizado come do Comedouro.

Luz verde intermitente. O Comedouro está no modo "Adicionar animal" - **consulte a página 183**. A luz continua a piscar até que adicione um microchip ou até que saia deste modo.

Luz laranja intermitente. O comedouro está em modo de treino - **consulte a página 187-188**. O número de vezes que pisca está relacionado com a fase de treino.

Luz vermelha intermitente. As pilhas estão fracas.

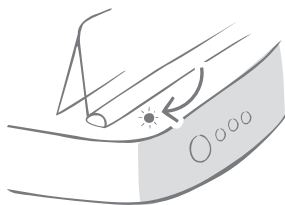

Luzes indicadoras de porção

Se configurou o peso de porção na aplicação Sure Petcare, as luzes na parte frontal do Comedouro servem de guia para adicionar comida.

As luzes indicadoras de porção representam a quantidade de comida que adicionou, para certificar-se de que o seu animal de estimação recebe a porção correta.

Para obter mais informações sobre os benefícios de porções corretas, **consulte a página 184**.

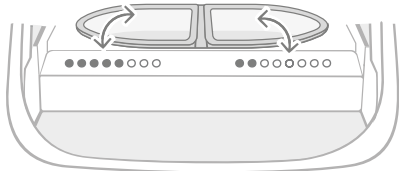
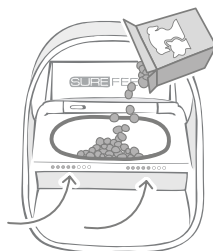

Utilizar meias tijelas

As luzes no lado direito do Comedouro correspondem à tijela direita e as luzes do lado esquerdo correspondem à tijela esquerda. As luzes acendem quando adicionar comida a cada um dos lados.

Utilizar tigela única

Ambas as luzes acendem simultaneamente quando adicionar comida à tigela única.

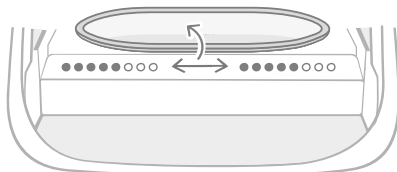

Se pretender mudar de meias tijelas para uma tigela única ou vice-versa, efetue a alteração na aplicação Sure Petcare.



Se não configurou um peso de porção na aplicação, as luzes não acendem quando adicionar comida ao comedouro.



Adicionar o seu animal ao Comedouro

Quando adicionar a ID do microchip do seu animal ao Microchip Pet Feeder Connect, certifique-se de que afasta todos os outros animais de estimação e etiquetas de coleira desnecessárias.

1

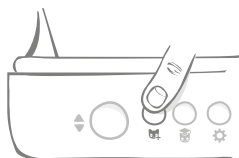

Prima o botão "Adicionar animal" (🐱) na parte traseira do Comedouro.

2

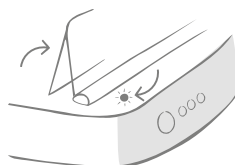

A tampa abre-se e o LED traseiro pisca a verde a cada segundo.

3

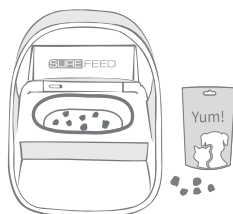

Coloque alguma/comida/guloseimas e ponha o Comedouro no lugar de alimentação do animal de estimação.

4

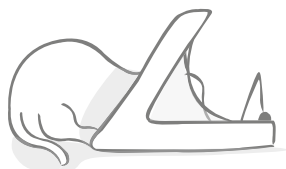

Enquanto o animal come, o Comedouro pode detetar a ID do microchip. Após adicionar a ID, **o LED para de piscar** (mas permanece aceso).

5

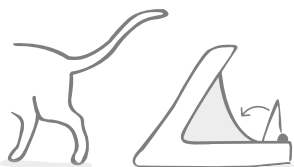

Quando o animal se afasta, a tampa fecha e o LED verde apaga-se. A ID do microchip está agora permanentemente guardada.

i



Se for necessária, pode cancelar o modo "Adicionar animal" em qualquer momento premindo pela segunda vez o botão "Adicionar animal" (🐱).



Para programar a ID do microchip de um animal, os sensores localizados do aro do Comedouro devem detetar a presença do animal. Por isso, é importante que o animal coloque a cabeça através do aro para comer.



Para programar uma Etiqueta RFID de coleira Sure Petcare, basta seguir os passos acima e manter a etiqueta de coleira dentro do aro. Certifique-se de que não utiliza joias metálicas quando programar a etiqueta de coleira.



Se já tem um animal de estimação no seu agregado, é possível atribuí-los ao Comedouro. Aceda à secção Agregado na aplicação. Se adicionar o animal de estimação errado por erro, pode sempre corrigi-lo aqui.



Configurar porções

O Microchip Pet Feeder Connect não só monitoriza quando e o que come o seu animal, mas também pode ajudá-lo a dosear corretamente as porções para o seu animal.

Porque deve dosear as porções do seu animal?

Seria bom que o seu animal perdesse alguns quilos? Ao configurar o peso da porção, pode garantir que não lhe dá demasiada comida todos os dias. E tudo conta!

A possibilidade de pesar as porções de comida diretamente no Comedouro torna a operação mais rápida, mais fácil e mais cómoda, garantindo que o animal ingere a quantidade correta.

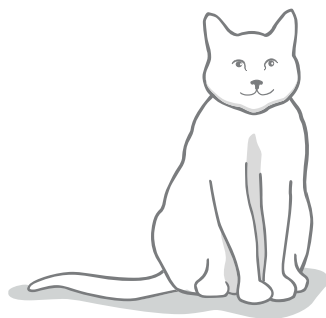

Que quantidade deve dar ao seu animal?

Pode ser difícil saber a quantidade correta para o seu animal, especialmente com tantas opções à sua escolha. Recomendamos que consulte o veterinário ou especialista animal.

Em alternativa, siga as orientações fornecidas na embalagem pelo fabricante da comida. Geralmente, estas informações são uma boa orientação para animais de estimação saudáveis.

Como configurar o peso de porção na aplicação

Pode configurar o peso de porção na aplicação Sure Petcare. Após a configuração, esta quantidade será enviada para o Comedouro para determinar a quantidade da porção de comida que pretende dar ao seu animal de estimação.

As luzes do indicador de porção no Comedouro orientam-no à medida que adiciona a comida para garantir que o seu animal recebe a porção correta. As luzes representam a quantidade de comida adicionada, **consulte a página 186** para obter mais informações.





Adicionar e substituir a comida

É importante alterar a comida do animal de estimação diariamente para garantir a saúde e bem-estar do animal e manter o Comedouro limpo e a funcionar corretamente.

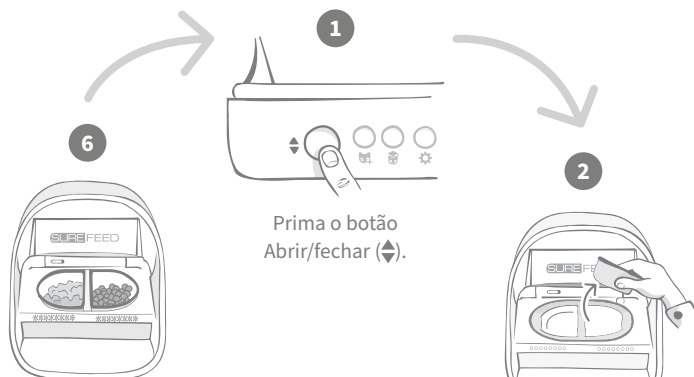

1
Prima o botão
Abrir/fechar (↕).

6
Quando todas as luzes estiverem a piscar a verde, significa que encheu as tijelas com a porção completa.

2
Remova as tijelas sujas e resíduos. Limpe-as ou substitua-as por novas.

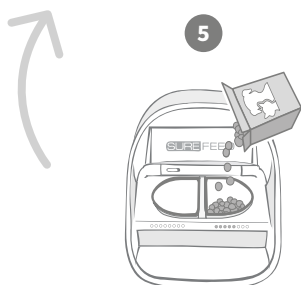

5
Após a sequência de luzes de reposição a zero, comece a encher as tijelas. As luzes indicadoras de porção iluminam-se para indicar a quantidade de comida em cada tijela – consulte a página seguinte.

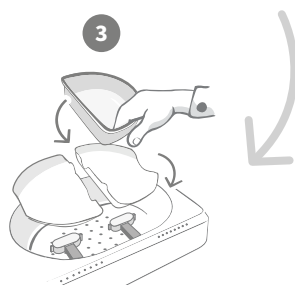

3
Certifique-se de que os suportes para tijela única ou meia tijela estão instalados corretamente nos braços de pesagem e **coloque uma tijela vazia no suporte.**



4
Prima o botão de reposição a zero antes de encher as tijelas para garantir que dá uma porção completa ao seu animal de estimação. Este botão repõe a zero **ambos os lados do Comedouro - consulte a página 181.**

Luzes indicadoras de porção



Sequência de luzes de reposição a zero:

Aparecem luzes verdes descendentes da direita para a esquerda quando prime o botão zero.



Adicionar comida:

À medida que adiciona comida, as luzes do indicador de porção acendem a verde, aumentando da esquerda para a direita. As luzes correspondem à quantidade de comida na tigela. Deve continuar a adicionar comida até que todas as luzes pisquem.



Attingir o peso da porção:

Quando está a +/- 1 g do peso da porção, as luzes **piscam a verde**. Se as luzes não piscarem, a porção não está completa.



Excesso de comida:

Se adicionar mais do que o peso da porção à tigela, as **luzes vermelhas** avisam-no do excesso de comida. Basta remover alguma da comida até que veja as luzes intermitentes a verde.



Se continuar sem definir um peso de porção na aplicação, as luzes indicadoras de porção **não acendem** quando adicionar comida ao comedouro.

Há comida restante na tigela?

Se ainda existir comida restante na tigela quando chegar a hora de jantar, não é necessário premir o botão de reposição a zero, basta adicionar mais comida ao comedouro e o comedouro permite-lhe adicionar uma nova porção à comida existente na tigela. A luz indicadora de porção permite adicionar uma porção completa e indica quando atingir o limite.

1

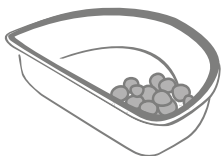

Quando abre a tampa, algumas luzes piscam momentaneamente para indicar que o comedouro deteta a comida restante na tigela. Em seguida, apagam-se todas as luzes para permitir adicionar uma nova porção à comida restante.

2

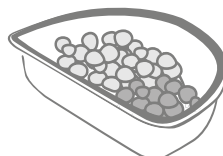

Encha a tigela até que as luzes indicadoras de porção pisquem a verde.



Modo de treino

(ensinar o seu animal de estimação a usar o Comedouro)



Quando abre com o botão Abrir/fechar, a luz laranja de treino pisca a vermelho para ajudar a identificar que o botão Abrir/fechar foi premido e que está no modo aberto. A luz de treino volta a laranja quando prime o botão Abrir/fechar após adicionar a porção de comida. **Se não premir o botão Abrir/fechar, as luzes indicadoras de porção não serão ativadas e o sistema não poderá identificar que está a adicionar comida.**

PARTE 1 - Apresentar o Comedouro ao seu animal

Alguns animais necessitam de algum tempo para se habituarem ao Comedouro. O modo de treino permite introduzir gradualmente mais movimento à tampa para que o animal ganhe confiança ao usar a tija. Pode demorar algum tempo, mas seja paciente e não avance para a **PARTE 2** até que o animal se sinta cómodo.

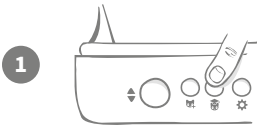

1 Com a tampa fechada, prima uma vez o botão "Modo de treino" (🐕) na parte traseira do Comedouro. A tampa abre-se e o LED traseiro pisca a laranja (uma vez em poucos segundos).

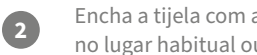

2 Encha a tija com a comida favorita do seu animal de estimação e coloque a unidade no lugar habitual ou em algum lugar onde o animal se sinta cómodo.



3 Durante a primeira fase do treino para utilizar o Comedouro, **a tampa não fecha** após o animal terminar de comer.



Tenha paciência e deixe que o animal se habitue à nova tija. Quando o animal se sentir confortável, continue para a PARTE 2.

PARTE 2 - Aumentar o movimento da tampa

Aumente lentamente o movimento da tampa para que o seu animal se habitue em três fases. Repetimos que é importante ter paciência e não apressar o processo para obter os melhores resultados e a felicidade do seu animal de estimação. O tempo necessário de cada fase depende de cada animal de estimação (dias/semanas), mas recomendamos que cada fase demore alguns dias.



4 Comece a aumentar o movimento da tampa premindo novamente o botão "Modo de treino" (🐕). A tampa fecha um pouco e o LED traseiro pisca duas vezes a laranja.

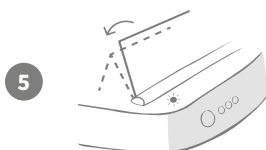

5

Agora, quando o animal comer no Comedouro, notará algum movimento quando a tampa abrir completamente. Quando o animal terminar de comer, a tampa fecha-se ligeiramente.



6

Permita que o seu animal se habitue ao novo movimento da tampa. Quando necessitar de substituir a comida, faça-o normalmente - **consulte a página 185**. Após substituir a comida, certifique-se de que prime o botão Abrir/fechar (↕) para fechar a tampa até à posição de treino.



Tenha paciência. Não continue para a fase seguinte até que o seu animal de estimação ganhe confiança com o nível de movimento da tampa.

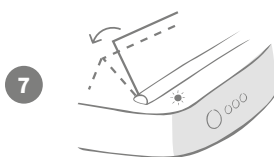

7

Quando o animal se sentir confortável com o movimento, prima novamente o botão "Modo de treino" (🐾). A tampa fecha até à posição seguinte e o LED traseiro pisca três vezes a laranja.



Continue a utilizar o Comedouro normalmente e não continue para a fase seguinte até que o seu animal de estimação ganhe confiança com este movimento.

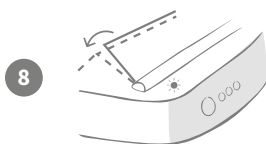

8

O seu animal deve agora sentir-se confortável com o movimento da tampa, por isso nesta fase final de treino a tampa fecha-se um pouco mais. Tal como nas fases anteriores, prima novamente o botão "Modo de treino" (🐾). A tampa fecha até à posição final e o LED traseiro pisca quatro vezes a laranja.



9

Quando o animal se sentir confortável com esta posição final, prima novamente o botão (🐾). A tampa fecha-se completamente e o LED traseiro deixa de piscar. O Comedouro está agora fechado e no modo de uso diário.



Pode terminar o modo de treino em qualquer momento mantendo premido o botão "Modo de treino" (🐾) durante **5 segundos**.



Se necessitar de retroceder um passo, siga a sugestão acima. Esta ação cancela o modo de treino e pode iniciar o processo desde o início.



Se o seu animal de estimação parecer nervoso quando a tampa se fecha após terminar de comer, pode ajustar a duração de tempo para fechar a tampa na aplicação Petcare.



Limpeza e manutenção

É importante manter limpo o Microchip Pet Feeder Connect para garantir o funcionamento correto. **NÃO submerja toda a unidade em água nem o coloque debaixo de água corrente. A água pode danificar o Comedouro e os seus sistemas eletrónicos.**

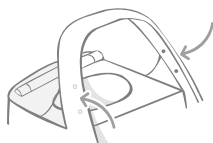
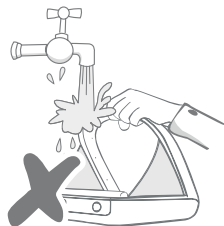

Certifique-se de que os quatro pontos pretos no aro se mantêm sempre limpos. Pode limpar o tapete com um pano húmido.

Não coloque os elementos na máquina de lavar louça. Lave apenas à mão.

O Microchip Pet Feeder Connect inclui uma **tampa de acesso para limpeza** na base para facilitar a remoção de migalhas ou resíduos.

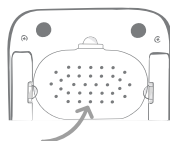

Como retirar a tampa para limpeza

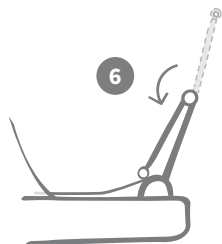

Em seguida, levante a metade superior da tampa para trás e apoie-a nas guias da tampa.

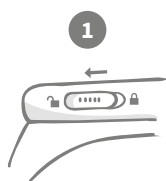

Mova a patilha de bloqueio da tampa para a posição desbloqueada.

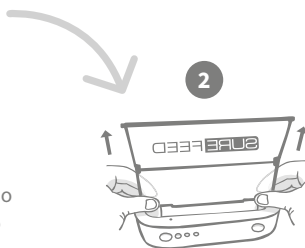

Prima o botão (◊). Após abrir a tampa, levante-a para cima.

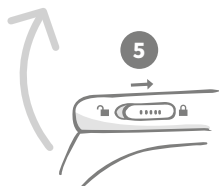

Mova a patilha de bloqueio da tampa para a posição bloqueada.

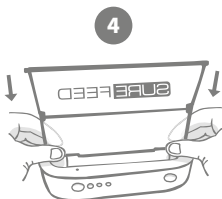

Após limpar, coloque novamente a tampa mantendo ambas as metades na vertical. Certifique-se de que está corretamente instalada.



Lave apenas à mão. **Não** coloque na máquina de lavar louça.

Como garantir a limpeza do Comedouro

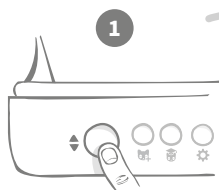

Prima o botão
Abrir/fechar (↕).

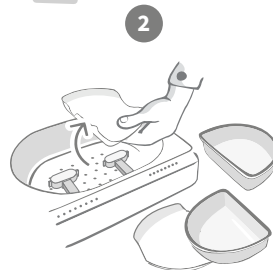

Retire as tigelas, suportes de tigela e tampa -
consulte a página anterior.



Recoloque as partes, certificando-se
de que **instala a tampa de acesso
para limpeza primeiro.**

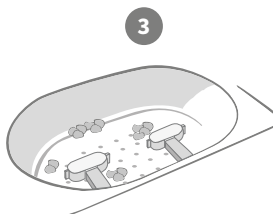

Os resíduos nos braços de pesagem podem
afetar o desempenho do Comedouro,
por isso é importante mantê-los limpos.
Não utilize esponjas abrasivas porque
podem danificar o Comedouro e causar
um funcionamento incorreto.

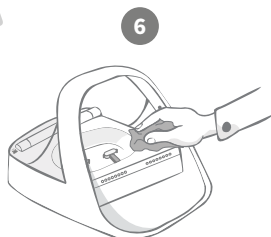

Utilize um pano húmido para garantir
que todas as superfícies do Comedouro
estão limpas. **Não utilize produtos
de limpeza abrasivos.**

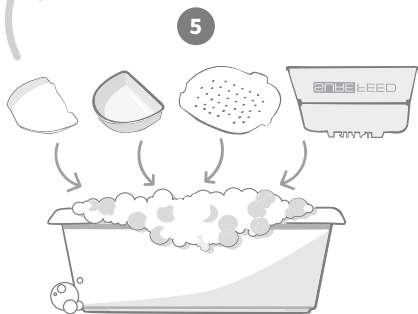

**Lave à mão todas as partes
removíveis.** Não coloque na
máquina de lavar louça.

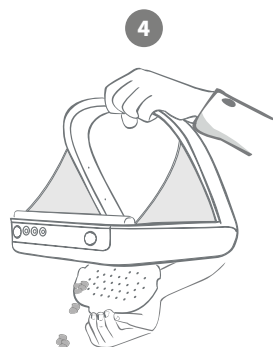

Segure o Comedouro sobre o caixote
do lixo, remova a tampa de acesso
para limpeza e despeje os resíduos.



Ajuda e suporte

Definições personalizadas

Compreendemos que nem todos os animais de estimação se comportam do mesmo modo, por isso concebemos o Microchip Pet Feeder Connect para se adaptar. O Comedouro contém várias definições personalizadas para ajudar se o seu animal de estimação utilizar o Comedouro de forma invulgar ou inesperada. Em seguida, encontra alguns exemplos de comportamento animal que as definições personalizadas podem ajudar a superar:

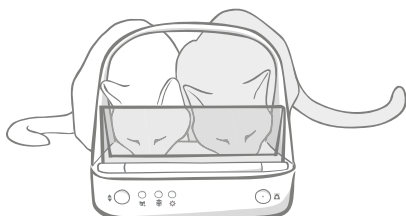

O seu animal de estimação não autorizado tenta comer ao mesmo tempo que o seu animal de estimação autorizado?

Temos uma definição personalizada para isso!

O seu animal de estimação não autorizado gosta de roubar comida do Comedouro de outro animal de estimação durante o modo de treino?

Temos uma definição personalizada para isso!

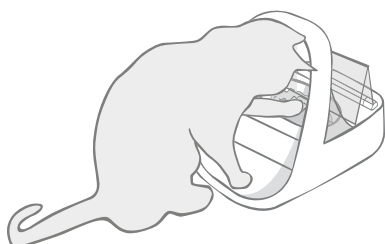

O seu animal de estimação não autorizado encontrou uma maneira de evitar que tampa feche?

Temos uma definição personalizada para isso!

O seu animal de estimação não autorizado tenta roubar comida pela parte traseira do Comedouro?

Temos um acessório para isso!

Aceda a superpetcare.com/accessories e procure Tampa traseira.

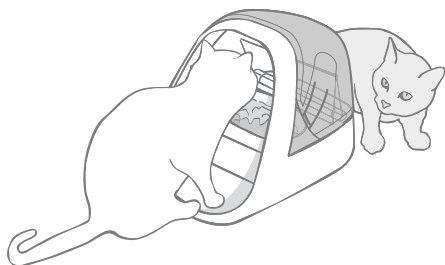

Contacte a nossa equipa de atenção ao cliente para discutir as definições personalizadas - **consulte a contracapa para obter mais detalhes**. A nossa equipa poderá recomendar a definição personalizada mais adequada à sua situação e configurá-la por si remotamente.

O Hub

Orelhas piscam a vermelho

O Hub perdeu a ligação com o Microchip Pet Feeder Connect.

- Se vir **ambas as orelhas piscarem a vermelho durante a configuração**, efetue a reposição de fábrica premindo o botão na base do Hub durante 10 segundos.
- Se vir **ambas as orelhas piscarem a vermelho durante longos períodos de tempo após a configuração**, experimente reiniciar o Hub. Desligue a alimentação na tomada, aguarde 30 segundos e ligue-a novamente. Se as orelhas continuarem iluminadas a verde fixo durante alguns minutos, significa que o Hub restabeleceu a ligação.
- Pode também experimentar **reposicionar o Hub** seguindo os conselhos na **página 177**. Se não funcionar, será necessário aproximar o Hub do Comedouro - consulte abaixo.
- Para aproximar o Hub, experimente ligá-lo ao router utilizando um cabo de Ethernet.
- Se a opção anterior não funcionar, recomendamos que compre um **adaptador de Ethernet por rede elétrica**. Pode ligá-lo a uma tomada elétrica comum e permite ligar o Hub à Internet num local mais próximo do comedouro.

Orelhas piscam alternadamente (vermelho ou verde)

O Hub está com dificuldade para ligar aos servidores Sure Petcare. Pode ser devido a uma ligação à Internet fraca.

- Experimente reiniciar o Hub desligando a alimentação na tomada, aguardando 30 segundos e ligando-a novamente. Se as orelhas continuarem iluminadas a verde fixo durante alguns minutos, significa que o Hub restabeleceu a ligação.
- Se as opções anteriores não funcionarem, certifique-se de que o router da Internet está ligado e que a ligação à Internet está a funcionar corretamente noutros dispositivos.
- Se não funcionar com outros dispositivos, experimente desligar o router, aguardar 30 segundos e ligá-lo novamente.
- Se o router funcionar com outros dispositivos, experimente ligar novamente o cabo de Ethernet no router e no Hub. Certifique-se de que insere o cabo corretamente porque pode parecer ligado e não estar completamente introduzido.

Se continuar com problemas de ligação, visite: surepetcare.com/hub-connectivity

Orelhas a vermelho fixo

O Hub está a atualizar o firmware. Seja paciente e aguarde até que as orelhas passem a verde. Não deve demorar mais de 2 minutos. Após concluir a atualização de firmware, é necessário reiniciar o Hub. Neste momento, pode ver a sequência luminosa de configuração - **consulte a página 178**.

Notificações demoradas

Se notar que algumas mensagens demoram a aparecer na aplicação, provavelmente deve-se a problemas de ligação do Hub ao Microchip Pet Feeder Connect. Para melhorar a celeridade das mensagens, experimente mover o Hub para uma melhor posição seguindo as recomendações na **página 177**.

Microchip Pet Feeder Connect

Se ocorrerem problemas mecânicos com o Comedouro, não tente repará-los. Em vez disso, contacte a nossa solícita equipa de atenção ao cliente - consulte a **contracapa** para ver as informações de contacto.

O Comedouro não abre para o meu animal de estimação

- Certifique-se de que os 4 sensores dentro do aro estão limpos - **consulte a página 189**.
- Certifique-se de que utiliza pilhas **alcalinas** de boa qualidade e que não estão fracas. Certifique-se de que as polaridades + e - das pilhas estão na posição correta - **consulte a página 179**.
- Afaste o Comedouro de aparelhos metálicos ou elétricos. Se o Comedouro ainda não abrir para o seu animal de estimação, consulte abaixo.
- Verifique se não existem fontes de ruído elétrico próximas, por exemplo, luzes intermitentes, etc. Se detetar ruído elétrico, contacte a nossa equipa de atenção ao cliente - **consulte a contracapa para obter mais detalhes**.
- Se as opções acima não funcionarem, consulte um veterinário para garantir que o microchip do seu animal de estimação está a funcionar e que está localizado no devido lugar. Se o microchip se moveu significativamente, a leitura pode ser difícil. Entretanto, pode utilizar a Etiqueta RFID de coleira Sure Petcare fornecida. Instale a etiqueta de coleira na coleira do seu animal de estimação e repita o processo "Adicionar animal" - **consulte a página 183**.

O meu animal de estimação não está cómodo ao utilizar o Comedouro

- Repita o processo de treino permitindo mais tempo para que o animal se sinta cómodo entre cada passo - **consulte a página 187-188**.
- Se o animal estiver demasiado cauteloso com o Comedouro, experimente seguir os passos em **surepetcare.com/cautiospet** e não force o animal a alimentar-se em nenhum momento.
- Avalie o ambiente de alimentação do animal. Aproxima-se sempre da tijela num determinado ângulo? Está preocupado por estar de costas para a porta? Não existe uma orientação definida para o Comedouro, mude-a se acha que pode ajudar o seu animal a sentir-se mais cómodo.
- Se o tempo para fechar a tampa (após o seu animal terminar de comer e se afastar) não for adequado para o animal, pode aumentar/diminuir o tempo para fechar na aplicação Sure Petcare.

A tampa do Comedouro não fecha completamente.

- Pode ser causado por resíduos de comida na tampa ou no mecanismo. Para garantir que a tampa fecha corretamente, é importante limpar todos os resíduos de comida das superfícies do Comedouro - **consulte a página 189-190**.
- Certifique-se de que não está em modo de treino, **visite a página 187** para saber mais sobre o comportamento do modo de treino.

As luzes indicadoras de porção estão ligadas mas a tijela está vazia

Se, quando abrir o Comedouro, as luzes indicadoras de porção estiverem ligadas a verde, mas não existir comida nas tijelas, é necessário repor a zero. Para resolver este problema, prima sempre o botão de reposição a zero antes de colocar a comida - **consulte a página 185-186**.

As luzes indicadoras de porção não respondem

- Se não definiu um peso de porção na aplicação Sure Petcare, as luzes indicadoras de porção não acendem quando adicionar comida ao comedouro.
- Além disso, os resíduos nos braços de pesagem podem afetar o desempenho do Comedouro, certifique-se de que esta área está sempre limpa - **consulte a página 189-190**.

Os outros animais roubam comida

- Se outros animais gulosos tentarem roubar comida de um Comedouro aberto, pode experimentar diminuir o tempo para fechar a tampa após o animal terminar de comer na aplicação Sure Petcare.
- Pode existir uma definição personalizada que o ajude a resolver o seu problema específico. Contacte a nossa equipa de atenção ao cliente para discutir a sua situação específica - **consulte a contracapa para obter informações de contacto**.
- Em alternativa, se os animais gulosos conseguem roubar comida pela parte traseira ou lateral do Comedouro (quando a tampa está aberta e o animal autorizado está a comer), temos uma tampa traseira que o ajudará a impedir esse comportamento astucioso. Para obter mais informações, aceda a **surepetcare.com/accessories**.

Curta duração da pilha

- Certifique-se de que o Comedouro está limpo e não existe sujidade nos sensores - **consulte a página 189**.
- Certifique-se de que utiliza pilhas de boa qualidade e que estão instaladas corretamente - **consulte a página 179**.
- Verifique se não existem fontes de ruído elétrico próximas (por exemplo, luzes intermitentes, etc.). Se detetar ruído elétrico, contacte a nossa equipa de atenção ao cliente. Consulte a **contracapa** para obter mais detalhes.

Vários comedouros num agregado

- Se for confuso para si ou para os seus animais saber qual é o respetivo comedouro, experimente utilizar tijelas de diferentes cores e locais de alimentação diferentes. Pode ajudá-lo com este problema. As tijelas e tapetes de diferentes cores são vendidos separadamente. Para obter mais informações, aceda a **surepetcare.com/accessories**.

Ainda necessita de assistência?



- Se continuar com problemas de ligação, visite: **surepetcare.com/hub-connectivity**
- Para obter mais orientações, vídeos e fóruns de ajuda ao cliente, visite: **surepetcare.com/support**
- Se tiver problemas com a sua aplicação Sure Petcare, visite: **surepetcare.com/apphelp**

Ou pode contactar a nossa solícita equipa de atenção ao cliente. **Consulte a contracapa para obter mais detalhes.**



Garantia e isenção de responsabilidade

Garantia: O SureFeed Microchip Pet Feeder Connect inclui uma garantia de 3 anos desde a data de compra, sujeita a apresentação do comprovativo de compra. A garantia está limitada a qualquer falha provocada por materiais, componentes ou fabrico defeituosos. Esta garantia não se aplica a produtos cujos defeitos sejam provocados pelo desgaste normal, utilização incorreta, negligência ou danos intencionais. Em caso de falha de uma peça devido a peças defeituosas ou fabrico, a peça será substituída sem custos apenas durante o período da garantia. Sob o critério exclusivo do fabricante, pode ser fornecida a substituição do produto sem custos em caso de uma avaria mais grave. Os seus direitos legais não são afetados.

Isenção de responsabilidade: O Microchip Pet Feeder Connect e a aplicação comunicam o consumo de comida pelo animal detetando a ID do microchip do animal de estimação e o peso da tigela antes e depois de comerem. Na maioria dos casos, serão indicados dados de consumo de comida fiáveis, no entanto, a utilização inesperada ou invulgar do Comedouro (por exemplo, um animal de estimação remove a tigela ou brinca com a comida) pode produzir informações incorretas. A Sure Petcare não se responsabiliza por quaisquer danos, prejuízos ou inconveniência decorrentes da comunicação incorreta do consumo de comida pelo animal.

O SureFeed Microchip Pet Feeder Connect incorpora funcionalidades de acesso seletivo concebidas para minimizar o risco de que um animal coma a comida de outro. No entanto, não é possível garantir totalmente a exclusão de todos os outros animais em todas as circunstâncias. No caso raro de que um animal obtenha acesso ao Comedouro, a Sure Petcare não se responsabiliza por quaisquer danos ou inconveniência incorridos.



Eliminação de produtos e pilhas usadas: Este ícone indica que os produtos estão sujeitos à seguinte legislação:

A diretiva de Resíduos de Equipamentos Elétricos e Eletrónicos de 2012/19/UE (Diretiva REEE) e a Diretiva Pilhas 2006/66/CE (e alteração de 2013/56/UE) obriga todos os lares a eliminarem os produtos EEE e baterias esgotadas que atingiram o fim de vida útil de forma ambientalmente responsável. Para reduzir o impacto dos resíduos no ambiente, estes produtos não devem ser eliminados com o lixo comum e devem ser reciclados em instalações de reciclagem adequadas. Pode encontrar mais informações sobre a reciclagem em: www.recycle-more.co.uk.

Certifique-se de substituir as pilhas antes da data de validade indicada na própria pilha ou na embalagem e elimine-as de forma segura e apropriada.

Em caso de fugas da pilha, utilize roupa de proteção adequada para se proteger contra a exposição a químicos nocivos antes de eliminar as pilhas e limpar qualquer derramamento. Quando limpar algum derramamento, evite o contacto com a pele. Não deve aproximar dos olhos ou ingerir os químicos das pilhas. Caso ocorra, contacte imediatamente um médico.

Marcas comerciais: Google Play e o logótipo Google Play são marcas comerciais de Google Inc. Apple é uma marca comercial de Apple Inc., registada nos EUA e noutros países. Apple Store é uma marca de serviço de Apple Inc., registada nos EUA e noutros países. iOS é uma marca comercial ou marca comercial registada de Apple Inc., registada nos EUA e noutros países e é utilizada sob licença.



SURE[™]
PETCARE

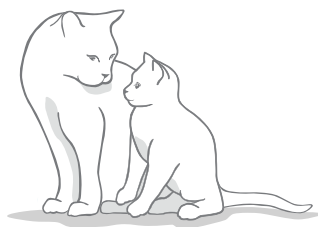

Tervetuloa käyttämään mikrosirutetun lemmikin Connect-ruoka-automaatti

Kiitos, että valitsit mikrosirutetun lemmikin Connect-ruoka-automaatin

Mikrosirutetun lemmikin Connect-ruoka-automaattijärjestelmä koostuu kolmesta osasta, joiden avulla pysyt yhteydessä lemmikkiisi ja saat entistä paremman kuvan sen syömistottumuksista.

Mikrosirutetun lemmikin Connect-ruoka-automaatti on järjestelmän pääasiallinen osa. Se tunnistaa mikrosirun, joka on jo laitettu lemmikkiisi, tai Sure Petcare RFID -kaulapantamerkin (yksi mukana) ja sallii lemmikillesi pääsyn ruokaan pitäen samalla muut eläimet poissa.

Keskitin (myydään erikseen) on järjestelmän yhteysistä vastaava osa. Se muodostaa yhteyden kodin langattomaan verkkoon ja viestii sekä ruoka-automaatin että Sure Petcare -sovelluksen kanssa.

Sure Petcare -sovelluksen avulla voit valvoa sitä, kuinka paljon lemmikki syö ja kuinka usein se käy ruoka-automaatilla. Sovelluksella voit myös lähettää ruoka-automaatille annospainon lemmikille tarjotun kerta-annoksen koon määrittämiseksi.

Pakkauksen sisältö

Varmista, että pakkauksessa on seuraavat osat*

- 1 1 mikrosirutetun lemmikin Connect-ruoka-automaatti
- 2 1 yksittäiskulho
- 3 2 puolikulhoa
- 4 1 matto
- 5 1 yksittäiskulhon tuki
- 6 2 puolikulhon tukea
- 7 1 Sure Petcare RFID -kaulapantamerkki

*Paristot ja keskitin eivät sisälly toimitukseen

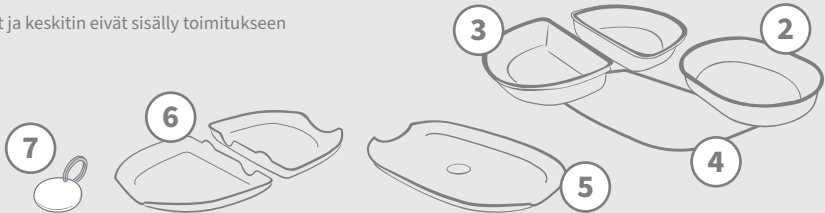
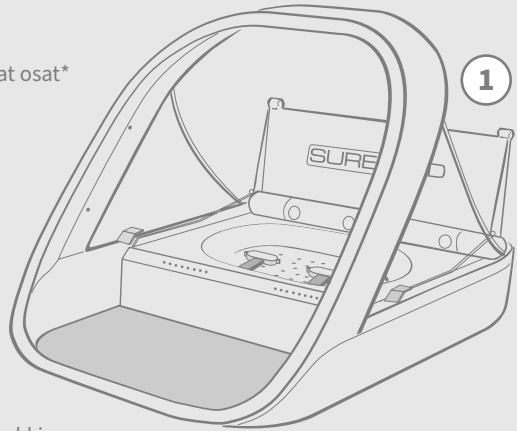

Jotta mikrosirutetun lemmikin Connect-ruoka-automaatti toimisi yhdistettynä järjestelmänä, siihen liittyvä keskitin on ostettava erikseen. Lisätietoja keskittimen ostamisesta on osoitteessa surepetcare.com/hub.

Sisällys

Tärkeitä tietoja.....	200
Tuote-esittely.....	202
Mikrosirutetun lemmikin Connect-ruoka- automaattijärjestelmä	204
Keskitin	
Keskittimen ottaminen käyttöön	205
Keskittimen sijoittaminen	206
Keskittimen valot	207
Ruoka-automaatti	
Paristot	208
Ruoka-automaatin yhdistäminen	209
Painikkeet ja valot	210
Lemmikin lisääminen ruoka-automaattiin	212
Annosten määrittäminen.....	213
Ruoan lisääminen ja vaihtaminen	214
Koulutustila	216
Puhdistus ja huolto	218
Ohje ja tuki.....	220
Takuu ja vastuuvapautuslauseke.....	224



Tärkeitä tietoja



LUE SEURAAVAT TIEDOT HUOLELLISESTI JA SÄILYTÄ TÄMÄ KÄYTTÖOPAS.



Tuote on tarkoitettu **vain kotieläimille**.



Varmista yhteensopivuus käyttämällä vain SureFeed-lisävarusteita:
surepetcare.com/accessories



Varmista, että pakkauksessa on kaikki **sivulla 197** luetellut osat.



Älä sijoita ruoka-automaattia paikkaan, josta kulkee paljon ihmisiä.



Ruoka-automaatti on suunniteltu **vain sisäkäyttöön**.



Älä upota ruoka-automaattia veteen tai aseta hanasta juoksevan veden alle.



Älä laita ruoka-automaattia jääkaappiin tai aseta jääpakkauksia sen alle tai sisään.



Älä aseta ruoka-automaattia mihinkään, missä se voi kuumentua liikaa.



Tuotteeseen vaaditaan **neljä C-alkaliparistoa**, joita tulee käsitellä varoen. Älä käytä useita erityyppisiä paristoja tai sekä käytettyjä että käyttämättömiä paristoja. Jos ruoka-automaatti siirretään varastoon pitkäksi ajaksi, irrota paristot.

Mikrosirutetun lemmikin Connect-ruoka-automaatin **tuotekoodi** ja **sarjanumero** löytyvät tuotteen alaosasta.

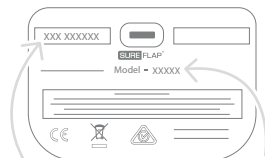

Sarjanumero

Tuotekoodi

Turvallisuusvaroitukset

- **Älä** käytä tuotetta, jos siitä puuttuu osia tai osat ovat vahingoittuneet tai kuluneet.
- **Tuotteessa on käytetty pieniä osia.** Pidä kaikki irralliset osat pienten lasten ulottumattomissa **tukehtumisvaaran välttämiseksi**.

Muita huomioitavia seikkoja



LEMMIKIT: Sure Petcare suosittelee, että SureFeedin mikrosirutetun lemmikin Connect-ruoka-automaattia käytetään lemmikin ihon alle laitetun mikrosirun avulla. Sitä voidaan käyttää myös Sure Petcare RFID -kaulapantamerkillä. Jos käytät kaulapantamerkkiä, kiinnitä se **häätätilanteessa aukeavalla soljella** varustettuun turvakaulapantaan (vain kissoille). Sure Petcare ei voi ottaa vastuuta lemmikin kaulapannasta aiheutuneesta vammasta tai kuolemasta.



RUOAN ANTAMINEN: Sure Petcare ei voi ottaa vastuuta, jos ei-tarkoituksenmukaisen käytön vuoksi luvaton lemmikki pääsee ruoka-automaatille. Tuotteen omistajana **sinulla on täysi vastuu valvoa sellaisen ruoan antamista**, josta voi olla haittaa muille lemmikeille vahingossa syötynä.



EI AJASTINTOIMINTOA: Tämä tuote ei sisällä ajastinta, **eikä siinä ole aikaan liittyviä toimintoja**. Älä jätä lemmikkiäsi ilman valvontaa tai luota siihen, että tämä tuote riittää niiden ruokkimiseen pitkäksi aikaa – kissojen kohdalla vuorokautta pitempään tai pienten koirien kohdalla pitempään kuin aterioiden välisen ajan. **Tämä tuote ei vapauta lemmikin omistajaa vastuustaan.**



LAPSET: Lapset **eivät saa leikkiä** SureFeed Microchip Pet Feeder Connect-ruoka-automaatilla. Tuote ei ole lelu. Vähintään 8-vuotiaat lapset tai fyysisesti, sensorisesti tai henkisesti rajoittuneet henkilöt voivat käyttää tuotetta valvonnan alaisina tai siinä tapauksessa, että heitä on ohjeistettu käyttämään sitä turvallisella tavalla. Heille on aina kerrottava käyttöön mahdollisesti liittyvistä vaaratekijöistä. Älä anna minkään ikäisten lasten puhdistaa tuotetta ilman valvontaa.



LAPSITURVALLISUUS: Lapsiperheissä on erittäin tärkeää **huomioida SureFeedin mikrosirutetun lemmikin Connect-ruoka-automaatti, kun kodista tehdään lapsiturvallinen**. Jos lapsi käyttää tuotetta väärin, lapsi voi joutua vaaraan. Sen vuoksi pieniä lapsia on valvottava jatkuvasti, kun he ovat ruoka-automaatin läheisyydessä. Huomaa, että laitteen ollessa **koulutustilassa (katso sivu 215–216) lapsi pääsee käsiksi lemmikin ruokaan**.



Tuote-esittely

Microchip Pet Feeder Connect -järjestelmä koostuu kolmesta pääosasta:

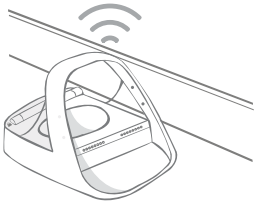

Microchip Pet Feeder Connect



Keskitin

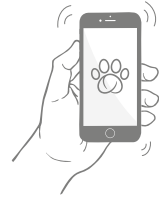

Sure Petcare
-sovellus

Keskitin on yhdistetty internetiin Ethernet-kaapelin kautta, ja se valvoo mikrosirutetun lemmikin Connect-ruoka-automaatin toimintaa. Se on yhteydessä ruokinta-automaattiin ja Sure Petcare -sovellukseen, joten näet päivityksiä Sure Petcare -sovelluksessa myös ollessasi poissa kotoa.

Sovelluksessa voi myös asettaa annospainon. Asettamisen jälkeen ruoka-automaatti opastaa sinua ruoan lisäämisen yhteydessä sen varmistamiseksi, että lemmikkisi saa oikeankokoisen annoksen. Lisätietoja on **sivulla 210**.

Tunnistimet: Lemmikin tunnistamiseen käytetään neljää pientä pistettä vanteen sisäpinnassa.

Matto: Suunniteltu keräämään ruokasotkut, jolloin ruoka-automaatti on helpompi puhdistaa.

Annosilmaisvalot:
katso sivu 210.

Kulhot ja kulhojen tuet:
katso sivu 202.

Kannen lukko:
katso sivu 209.

**Takaosan
merkkivalo:**
katso sivu 210.

Painikkeet:
katso sivu 209.

Paristolokerot:
katso sivu 207.

Puhdistusluukku:
katso sivu 217.

Keskittimen valot:
katso sivu 206.

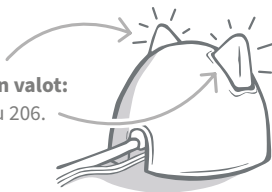

Ethernet-portti:
muodostaa yhteyden internet-reitittimeen.

Virtalähde:
virtalähteen johdon kytkemiseen.

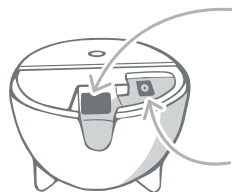

SureFeed-kulhojen yläreunassa on kiinteä tiiviste, jotta lemmikin ruoka säilyy tuoreena pitempään. Jos ruokit lemmikkiä vain yhdentyypisellä ruoalla, voit käyttää yksittäiskulhoa. Jos taas annat lemmikille sekä märkä- että kuivaruokaa, ruokkimiseen sopivat parhaiten puolikulhot.



Yksittäiskulho – kulhoon mahtuu 250 g ruokaa eli vähintään kaksi märkäruokapussia.

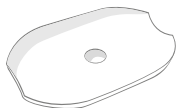

Yksittäiskulhon tuki – tarkoitettu yksittäiskulholle (ei puolikulhoille).

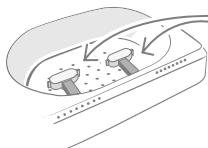

Punnitusvarret – suunniteltu kannattelemaan kulhon tukea.



Puolikulhot – yhteen kulhoon mahtuu 100 g ruokaa eli molempiin yhteensä 200 g.



Puolikulhon tuki – yksi tuki on tarkoitettu yhdelle puolikulholle (ei yksittäiskulholle).

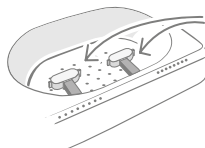

Punnitusvarret – suunniteltu kannattelemaan kulhojen tukia.

Älä aseta lemmikkisi ruokaa suoraan kulhojen tukien päälle. Käytä aina kulhoja varmistaaksesi, että ruoka-automaatti toimii oikein.



Jaettua SureFeed-kulhoa ei ole tarkoitettu käytettäväksi mikrosirutetun lemmikin Connect-ruoka-automaatin.

Osta lisäkulhoja ja -mattoja Sure Petcare -jälleenmyyjältä tai osoitteesta surepetcare.com.

Lisää väriä



SureFeed-muovikulhoja ja -mattoja on neljää väriä: musta, vihreä, vaaleanpunainen ja harmaa.

Tai lisää kiillettä

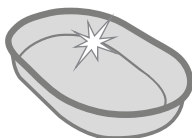

SureFeedin yksittäiskulho on saatavana myös ruostumattomana teräksenä.



Älä laita kulhoja astianpesukoneeseen tai mikroaaltouuniin.



Pese kulhot käsin ennen ensimmäistä käyttökertaa.



Mikrosirutetun lemmikin Connect-ruoka-automaattijärjestelmä

Lataa Sure Petcare -sovellus

LATAA
APP STORESTA

GET IT ON
GOOGLE PLAY

 surepetcare.io



Saat ilmoituksia, kun lemmikki syö ruoka-automaatista.



Valvo lemmikin syömistottumuksia ja käyttäytymisen muutoksia.



Annostele ruoka tarkasti hallitaksesi kerralla syödyn ruoan määrää.



Jaa kotitaloutesi käyttöoikeus perheenjäsenien ja ystävien kanssa.



Lataa **Sure Petcare -sovellus** ja luo itsellesi tili. Sinua kehoitetaan luomaan ”kotitalous” (kaikkien verkkoon yhdistettyjen Sure Petcare -tuotteidesi ja lemmikkiesi muodostama verkosto). Voit myös kutsua muita perheenjäseniäsi liittymään kotitalouteesi.

Sovelluksen lataaminen edellyttää, että puhelimesi tai tablettisi käyttöjärjestelmä on vähintään **iOS 9 (Apple-laitteet)** tai **4.4 (Android-laitteet)**.



Jos haluat mieluummin hallinnoida verkkoon yhdistettyjä Sure Petcare -laitteitasi, voit käyttää Sure Petcare -verkkosovellusta osoitteessa **surepetcare.io**.

Tarvitset tähän uusimman version **Safari-, Chrome-, Firefox- tai Internet Explorer** -selaimesta ja tietokoneen, jonka käyttöjärjestelmä on joko **Mac OS X 10.9** (tai sitä uudempi) tai **Windows 7** (tai sitä uudempi).

Sure Petcare -keskittimen ostaminen



Jotta mikrosirutetun lemmikin Connect-ruoka-automaatti toimisi Sure Petcare -sovelluksen kanssa, siihen liittyvä keskitin on ostettava erikseen. Lisätietoja on osoitteessa **surepetcare.com/hub**.



Keskittimen ottaminen käyttöön

Kun olet ladannut Sure Petcare -sovelluksen, sinun on kytkettävä keskitin verkkovirtaan ja otettava se käyttöön. Kun keskitin on otettu käyttöön, sinua pyydetään yhdistämään se sekä ruoka-automaattiin että sovellukseen. Noudata seuraavia ohjeita:

1

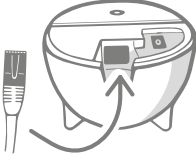

Kytke Ethernet-kaapeli keskitimen pohjaan ja toinen pää vapaaseen Ethernet-porttiin reitittimessä.

2

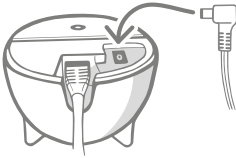

Kokoa verkkolaite ja kytke se pistorasiaan. Kytke virtajohdon toinen pää keskitimen pohjaan.

3



Keskittimen ”korvat” alkavat palaa **vuorotellen punaisena ja vihreänä**. Kun molemmat korvat palavat vihreänä, keskitin on valmis. Jos korvat eivät ala palaa vihreänä, katso lisätietoja **sivulta 206**.

4



Viimeistele Connect-ruoka-automaattijärjestelmän käyttöönotto **suorittamalla jäljellä olevat vaiheet Sure Petcare -sovelluksessa**.

i

Keskitin voi saada ohjelmistopäivityksen. Jos **valot palavat tasaisesti punaisena** käyttöönoton aikana, älä huolestu. Keskitinohjelmistoa päivitetään. Kun päivitys on valmis, keskitin käynnistyy uudelleen ja näet vaiheessa 3 kuvatut valot.



Keskittimen sijoittaminen

Koska mikrosirutetun lemmikin Connect-ruoka-automaattijärjestelmä viestii langattomasti, keskittimen sijainti voi vaikuttaa sen suorituskykyyn.



Aseta keskitin vähintään metrin korkeudelle lattiasta (eli pöydälle, jossa on mahdollisimman vähän esteitä).

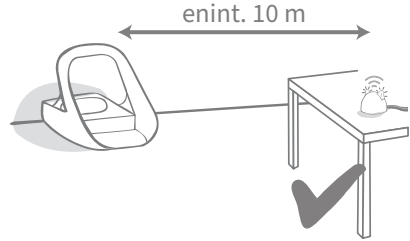

Yritä sijoittaa keskitin niin, että se on näköetäisyydellä ja enintään 10 metrin etäisyydellä ruoka-automaatista.

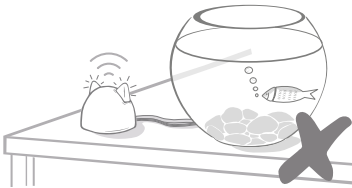

Vältä keskittimen sijoittamista akvaarioiden tai muuten suurten vesimäärien lähelle tai näköetäisyydelle niistä.

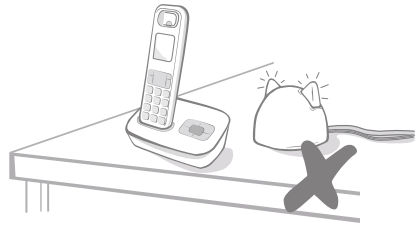

Sijoita keskitin mahdollisimman kauas mahdollisista häiriölähteistä, kuten langattomista digitaalipuhelimista tai itkuhälyttimistä.

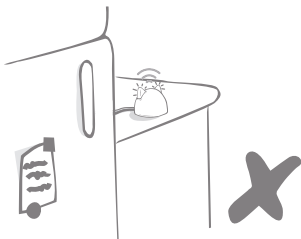

Älä sijoita keskitintä suurikokoisten metalliesineiden, kuten jääkaapin, viereen.

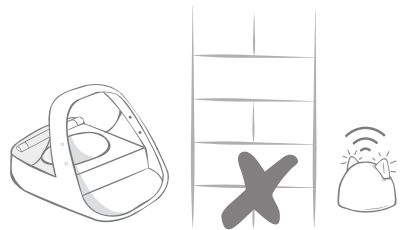

Vältä keskittimen sijoittamista niin, että sen ja ruoka-automaatin välissä on paksu seinä.



Toisinaan keskittimen toiminnassa voi ilmetä häiriöitä näiden ohjeiden noudattamisesta huolimatta. Lisätietoja keskittimen siirtämisestä lähemmäs Connect-ruoka-automaattia on osoitteessa surepetcare.com/hub-connectivity.



Vaikka keskittimen internet-yhteys jostain syystä katkeaisi, Connect-ruoka-automaatti toimii edelleen normaalisti ja säilyttää asetuksensa.



Keskittimen valot

Keskitin ilmaisee kulloisenkin tilansa korviensa valoilla. Eriväriset valosarjat merkitsevät eri asioita.

Käynnistysvalot

Aina kun keskitin käynnistyy tai yrittää muodostaa yhteyden muihin järjestelmän osiin, näet käynnistysvalot:

- 1** Korvat palavat jonkin aikaa **vuorotellen punaisina**.

- 2** Sitten ne palavat **vuorotellen vihreinä**.

- 3** Kun näet **oranssin vilkahduksen** ja korvat alkavat **palaa vihreinä**, keskitin on muodostanut yhteyden.



Vihreät korvat

Vihreät korvat ilmaisevat, että keskitin toimii oikein. Seuraavassa on tarkat tiedot siitä, mitä kukin valoyhdistelmä ilmaisee.

Molemmat korvat palavat vihreänä – Keskitin on päällä, sillä on yhteys ja se toimii normaalisti.

Korvat palavat vuorotellen vihreänä – Keskitin muodostaa palvelinyhteyttä.

Punaiset korvat

Molemmat korvat palavat punaisena – Keskittimen ohjelmistoa päivitetään. Odota hetki, kunnes keskitin käynnistyy uudelleen ja jatkaa toimintaansa.

Molemmat korvat vilkkuvat punaisena – Keskittimen yhteys ruoka-automaattiin on katkennut, ja sitä muodostetaan uudelleen.

Korvat palavat vuorotellen punaisena – Keskittimellä on vaikeuksia muodostaa yhteyttä internetiin tai palvelimiin.

i Lisätietoja näiden ongelmien vianmäärityksestä on **sivulla 220**.



Paristot

Käytä aina **neljää laadukasta 1,5 voltin C-alkaliparistoa**. Tämä varmistaa mikrosirutetun lemmikin Connect-ruoka-automaatin -laitteen parhaan toiminnan. **Tuotetta EI ole suunniteltu käytettäväksi ladattavien paristojen kanssa**. Syötä tai vaihda paristot noudattamalla alla olevia vaiheita:



Ruoka-automaatin takaosassa on valo. Tämä valo vilkkuu punaisena viiden sekunnin välein, kun paristot ovat vähissä, tai jos ne on asetettu laitteeseen väärin.

1

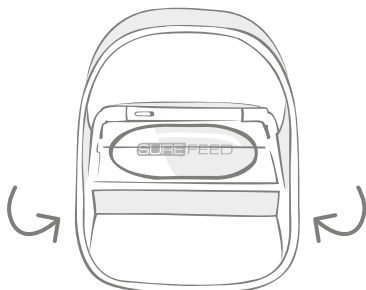

Käännä ruoka-automaatti ylösalaisin saadaksesi paristolokeron esiin.

2

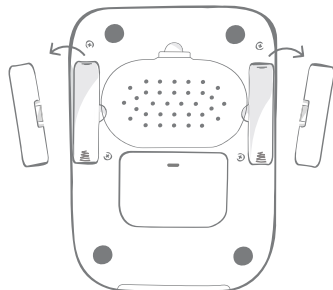

Poista paristokannet.

3

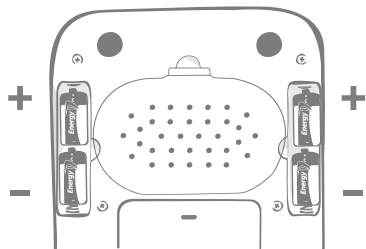

Syötä paristot. Varmista, että paristojen +/-symbolit vastaavat ruoka-automaatin symboleita.

4

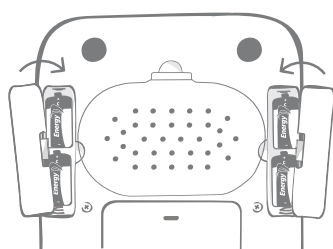

Laita paristokannet takaisin.



Kun olet ohjelmoinut lemmikkisi mikrosirutunnuksen ruoka-automaattiin, se tallennetaan pysyvästi laitteen muistiin. Tämä tarkoittaa, että laite tunnistaa ruokittavaksi tarkoitetut lemmikit myös paristojen vaihtamisen jälkeen.



Ruoka-automaatin yhdistäminen

Yhdistetyn järjestelmän käyttöönoton viimeistelemiseksi ruoka-automaatti on yhdistettävä kotitalouteen.

1

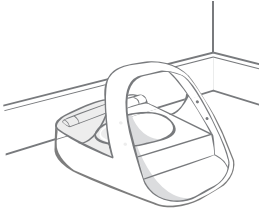

Aseta ruoka-automaatti sille tarkoitettuun paikkaan. Tämä varmistaa, että laite pystyy viestimään keskitimen kanssa.

2



Valitse Sure Petcare -sovelluksesta **Add product** (Lisää tuote).

3



Keskitin siirtyy yhteyden muodostustilaan, ja sen korvat vilkahtavat vihreänä.

4

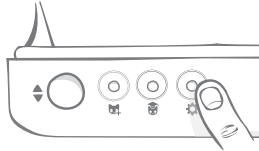

Paina ruoka-automaatin asetuspainiketta  kerran. Korvien valo syttyy palamaan vihreänä.

5

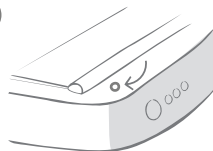

Kun ruoka-automaatti on yhdistetty, merkkivalo sammuu ja keskitin lakkaa vilkkumasta.

i



Jos haluat yhdistää useampia ruoka-automaatteja, se onnistuu helposti sovelluksessa.

Ruoka-automaatin lisääminen nykyiseen kotitalouteen



Voit lisätä Connect-ruoka-automaatin nykyiseen Sure Petcare -kotitalouteesi sovelluksessa. Siirry Household (Kotitalous) -osioon ja seuraa yllä olevia ohjeita.

Voit myös määrittää lemmikisi mikrosirutunnuksen etäyhteydellä sovelluksen kautta. Tällöin sinun ei tarvitse lisätä lemmikkiä manuaalisesti. Lemmikkien lisääminen herkkujen avulla voi kuitenkin rohkaista niitä käyttämään uutta tuotetta. Lisätietoja lemmikkien lisäämisestä on **sivulla 211**.



Painikkeet ja valot

Painikkeet

Ruoka-automaatissa on viisi painiketta. Ne sijaitsevat laitteen takaosassa:

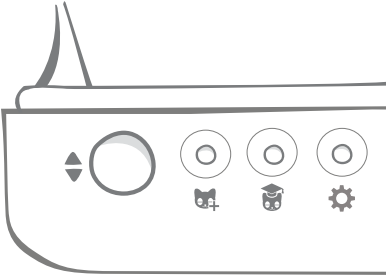

Avaus-/sulkupainike – avaa ja sulkee kannen, jotta pääset käsiksi kulhoihin.



Lemmikin lisäspainike – käytetään lemmikin mikrosirutunnuksen lisäämiseen ruoka-automaattiin – **katso sivu 211**.



Koulutustilapainike – käytetään aktivoimaan koulutustila, jonka avulla lemmikkiä opetetaan käyttämään ruoka-automaattia – **katso sivu 215-216**.



Asetukset-painike – käytetään yhdistämään ruoka-automaatti keskittimeen – **katso sivu 208**.



Nollauspainike – käytetään ruoka-automaatin kalibroimiseen ja sen varmistamiseen, että annetut ruoka-annokset ovat oikean kokoisia – **katso sivu 213**. Tämän painikkeen painaminen nollaa **ruoka-automaatin molemmat puolet riippumatta siitä, käytetäänkö yksittäiskulhoa vai puolikulhoa**.

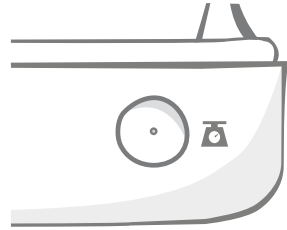

Jos käytät **puolikulhoja** ja haluat nollata ne erikseen, tee se **Sure Petcare -sovelluksessa**.

Kannen lukko



Lukittu – ilmaisee, että kanta ei voi irrottaa vetämällä ruoka-automaatista.



Lukitsematon – kun lukko on auki, kannen voi irrottaa vetämällä.

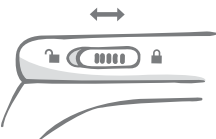

Kannen lukon tulee olla **lukittuna koko ajan**. Se kannattaa avata vain, kun haluat poistaa kannen laitteen puhdistamista varten. Näin voit estää taitavia mutta luvattomia lemmikkejä irrottamasta kanta ja pääsemästä käsiksi ruokaan. **Huomaa, että tämä ei estä kannen avautumista.**

Takaosan merkkivalo

Tasaisena palava vihreä valo. Vihreä valo syttyy joka kerta, kun luvallinen lemmikki syö ruoka-automaatista.

Vilkuva vihreä valo. Ruoka-automaatti on lemmikin lisäämistilassa – **katso sivu 211**. Valo vilkkuu edelleen, kunnes mikrosiru lisätään tai kunnes tilasta poistutaan.

Vilkuva oranssi valo. Ruoka-automaatti on koulutustilassa – **katso sivu 215-216**. Vilkahdusten lukumäärä viittaa koulutusvaiheeseen.

Vilkuva punainen valo. Paristot ovat vähissä.

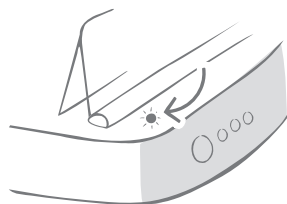

Annosilmaisinalot

Jos olet määrittänyt annospainon Sure Petcare -sovelluksessa, ruoka-automaatin etuosan valot opastavat ruoan lisäämisessä.

Annosilmaisinalot ilmaisevat lisäämäsi ruoan määrän, jotta voit olla varma, että lemmikkisi saa oikeankokoisen annoksen.

Lisätietoja tarkan annostelun eduista on **sivulla 212**.

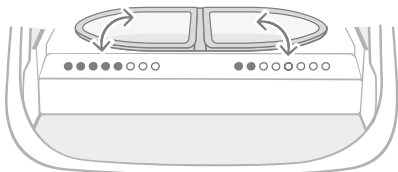
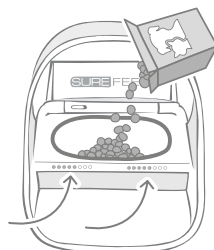

Puolikulhojen käyttö

Ruoka-automaatin oikean puolen valot vastaavat oikeanpuoleista kulhoa ja vasemman puolen valot vasemmanpuoleista kulhoa. Valot palavat sen mukaan, kummalle puolelle lisätään ruokaa.

Yksittäiskulhon käyttö

Kun ruokaa lisätään yksittäiskulhoon, valot syttyvät molemmilla puolilla.

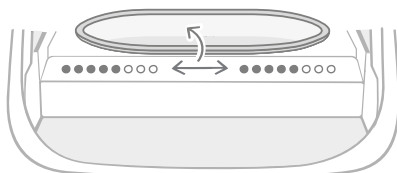

Jos haluat vaihtaa puolikulhoista yksittäiskulhoon tai päinvastoin, muutos on tehtävä Sure Petcare -sovelluksessa.



Jos sovelluksessa ei ole asetettu annospainoa, merkkivalot eivät syty, kun ruoka-automaattiin lisätään ruokaa.



Lemmikin lisääminen ruoka-automaattiin

Kun lisäät lemmikin mikrosirutunnusta Connect-ruoka-automaattiin, varmista, että lähellä ei ole muita lemmikkejä tai asiaankuulumattomia kaulapantamerkkejä.

1

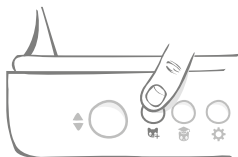

Paina lemmikin lisäyspainiketta (🐾) ruoka-automaatin takaosassa.

2

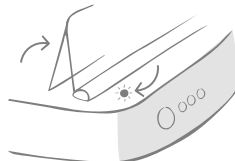

Kansi avautuu ja takaosan merkivalo vilkkuu vihreänä kerran sekunnissa.

3

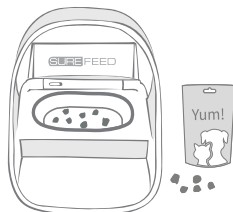

Laita ruokaa/herkuja kulhoon ja aseta ruoka-automaatti paikkaan, jossa tavallisesti ruokit lemmikkiäsi.

4



Kun lemmikki syö, ruoka-automaatti skannaa sen mikrosirutunnuksen. Kun tunnus on lisätty, **merkivalo lakkaa vilkkumasta** (mutta jää palamaan).

5

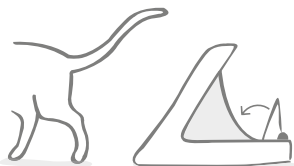

Kun lemmikki siirtyy pois laitteelta, kansi sulkeutuu ja vihreä valo sammuu. Lemmikin mikrosirutunnus on nyt tallennettu pysyvästi.

i



Tarvittaessa voit peruuttaa lemmikin lisäystilan milloin tahansa painamalla lemmikin lisäyspainiketta (🐾) toistamiseen.



Lemmikin mikrosirutunnistetta ohjelmoitaessa ruoka-automaatin vanteessa sijaitsevien tunnistinten on havaittava lemmikki. Siksi on tärkeää varmistaa, että lemmikki laittaa päänsä vanteen läpi syödäkseen.



Jos haluat ohjelmoida Sure Petcare RFID -kaulapantamerkin, noudata edellä annettuja ohjeita mutta pidä kaulapantamerkkiä vanteen sisällä. Varmista, ettei ylläsi ole metallista valmistettuja koruja, kun ohjelmoit kaulapantamerkkiä.



Jos Sure Petcare -kotitalouteesi kuuluu jo lemmikki, se voidaan lisätä ruoka-automaattiin. Siirry sovelluksen Household (Kotitalous) -osioon. Jos lisäät vahingossa väärän lemmikin, voit korjata virheen täällä.



Annosten määrittäminen

Sen lisäksi, että mikrosirutetun lemmikin Connect-ruoka-automaatti valvoo, mitä ja milloin lemmikki syö, se auttaa myös annostelevaan lemmikin ruoan oikein.

Miksi lemmikin ruoka kannattaa annostella?

Olisiko lemmikkisi syytä laihtuttaa? Asettamalla annoskoon voit varmistaa, ettet vahingossa tarjoa lemmikille jatkuvasti liikaa ruokaa. Jatkuva ylensyönti näkyy vähitellen lanteilla!

Ruoka-annosten punnitsemismahdollisuuden avulla lemmikin syömän ruoan määrän hallinta on kätevää.

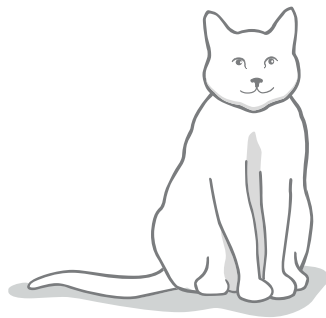

Kuinka paljon ruokaa lemmikille pitäisi antaa?

Sopivan annoskoon arvioiminen voi olla hankalaa, etenkin kun ruokavaihtoehtoja on niin paljon. Kannattaa ottaa yhteyttä eläinlääkəriin tai eläinten terveysneuvontaan ja pyytää ruokintasuosituksia.

Vaihtoehtoisesti voit myös noudattaa pakkaukseen painettuja lemmikinruokavalmistajan ohjeita. Nämä ohjeet soveltuvat yleensä hyvin terveelle keskivertolemmikille.

Annospainon asettaminen sovelluksessa

Voit asettaa annospainon Sure Petcare -sovelluksessa. Asetettu määrä lähetetään ruokinta-automaattiin, jotta laite tietää, kuinka paljon ruokaa lemmikin tulisi saada ateriana kohti.

Ruoka-automaatin annosilmaisinalot opastavat ruokaa lisättäessä oikeankokoisen annoksen varmistamiseksi. Valot ilmaisevat lisätyn ruoan määrää, katso lisätietoja **sivulta 214**.





Ruuan lisääminen ja vaihtaminen

On tärkeää vaihtaa lemmikin ruoka päivittäin – ei vain siksi, että lemmikki pysyy onnellisena ja terveenä, vaan myös ruoka-automaatin pitämiseksi puhtaana ja kunnossa.

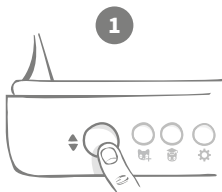

1
Paina avaus-/
sulkupainiketta (↕).



6
Kun kaikki valot vilkkuvat vihreänä,
kulhoissa on täysi annos.



2
Poista likaiset kulhot ja ruokajäämät.
Puhdista ne tai korvaa puhtailla.



5
Nollausvalojen jälkeen ala täyttää kulhoja.
Annosilmävalot näyttävät, kuinka
paljon kussakin kulhossa on ruokaa –
katso seuraava sivu.

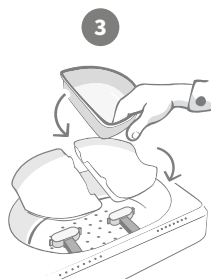

3
Varmista, että asianmukaiset
yksittäis- tai puolikulhojen tuet
istuvat kunnolla punnitusvarsilla,
ja **asetä tyhjä kulho päälle**.



4
Paina nollauspainiketta ennen kulhojen täyttämistä
varmistaaksesi, että annat lemmikille täyden annoksen.
Tämän painikkeen painaminen nollaa **ruoka-automaatin**
molemmat puolet – katso sivu 209.

Annosilmaisvalot



Nollausvalot:

Kun nollauspainiketta on painettu, valot laskevat oikealta vasemmalle.



Ruoan lisääminen:

Kun ruokaa lisätään, annosilmaisvalot syttyvät palamaan vihreänä vasemmalta oikealle nousten. Valojen määrä ilmaisee lisätyn ruoan määrän. Lisää ruokaa, kunnes kaikki valot vilkkuvat.



Annospainon saavuttaminen:

Kun laitteeseen lisätyn ruoan paino on yhden gramman sisällä asetetusta annospainosta, valot **vilkkuvat vihreänä**. Jos valot eivät vilku, annos on vajaa.



Ylitäyttö:

Jos kulhoon lisätään enemmän kuin annospainon verran ruokaa, **punaiset valot** ilmaisevat, kuinka paljon liikaa ruokaa on. Poista ruokaa, kunnes valot vilkkuvat vihreänä.



Huomaa, että jos sovelluksessa ei ole asetettu annospainoa, annosilmaisvalot **eivät syty**, kun ruoka-automaattiin lisätään ruokaa.

Onko kulhossa vielä ruokaa?

Jos ruoka-ajan lähestyessä kulhossa on ruokaa jäljellä, nollauspainiketta ei tarvitse painaa. Voit lisätä kulhoon uuden annoksen jäljellä olevan ruoan päälle. Annosilmaisvalot ilmaisevat, kun uutta ruokaa on lisätty kokonaisen annoksen verran.

1

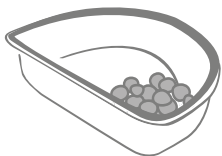

Kun avaat kannen, osa valoista vilkahtaa sen merkiksi, että ruoka-automaatti tietää kulhossa olevan ruokaa jäljellä. Tämän jälkeen valot sammuvat, jotta voit lisätä uuden annoksen jäljellä olevan ruoan päälle.

2

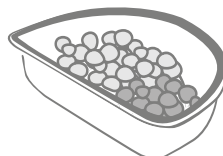

Lisää kulhoon ruokaa, kunnes kaikki annosilmaisvalot vilkkuvat vihreänä.



Koulutustila

(lemmikin kouluttaminen ruoka-automaatin käyttöön)

Kun laite avataan avaus-/sulkupainikkeella, oranssi koulutusvalo vilkkuu punaisena sen merkiksi, että avaus-/sulkupainiketta on painettu ja että laite on avattu-tilassa.



Koulutusvalo alkaa taas palaa oranssina, kun avaus-/sulkupainiketta painetaan ruoka-annoksen lisäämisen jälkeen. **Jos avaus-/sulkupainiketta ei paineta, annosilmäpaineet eivät aktivoitu eikä järjestelmä tunnista ruoan lisäämistä.**

OSA 1 – Ruoka-automaatin esitteleminen lemmikille

Joskus lemmikeiltä kestää hetki totutella ruoka-automaattiin. Koulutustilan avulla voit hitaasti lisätä yhä enemmän liikettä kanteen, mikä tarkoittaa, että lemmikkisi kasvattaa varmuutta vähitellen uuden kulhon käyttöön. Tämä voi viedä jonkin aikaa, mutta odota kärsivällisesti äläkä siirry **OSAAN 2**, ennen kuin lemmikki on tottunut laitteeseen.

1

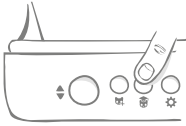

Paina kansi suljettuna ruoka-automaatin takaosan Koulutustila-painiketta (🎓) kerran. Kansi avautuu ja takaosan merkkivalo vilkkuu oranssina (muutaman sekunnin välein).

2

Täytä kulho lemmikkisi lempiruoalla ja aseta laite lemmikin tavanomaiseen ruokailupaikkaan tai muuhun paikkaan, jossa se voi syödä rauhassa.

3



Tämän ensimmäisen koulutusvaiheen aikana **laitteen kansi ei sulkeudu** sen jälkeen, kun lemmikki on lopettanut syömisen.



Muista varata aikaa ja anna lemmikkisi totutella uuteen kulhoonsa. Kun syöminen sujuu ongelmitta, siirry OSAAN 2.

OSA 2 – Kannen liikkeen lisääminen

Kun kannen liikettä lisätään hitaasti, lemmikki tottuu siihen kolmessa vaiheessa. Tässäkin vaiheessa kannattaa edetä kärsivällisesti ja kiireettä, jotta koulutus onnistuu ja lemmikki pysyy tyytyväisenä. Kussakin vaiheessa voi kulua lemmikin mukaan useita päiviä tai jopa viikkoja. Suosittelemme varaamaan joka vaiheelle vähintään muutaman päivän.

4

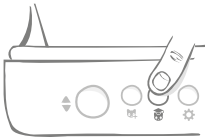

Ala lisätä kannen liikettä painamalla Koulutustila-painiketta (🎓) jälleen kerran. Kansi sulkeutuu vähäsen, ja takaosan merkkivalo vilkkahtaa kahdesti oranssina.

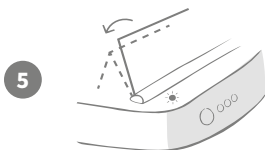

5

Nyt kun lemmikkisi syö kulhosta, on jonkinlaista liikettä, kun kansi avautuu täysin. Kun ne lopettavat syömisen, se sulkeutuu hieman.



6

Anna lemmikkisi tottua rauhassa kannen uuteen liikkeeseen. Kun ruoka on vaihdettava, tee se normaalisti – **katso sivu 213**. Kun ruoka on vaihdettu, varmista, että painat avaus-/sulkupainiketta (◆) sulkeaksesi kannen sen koulutusasettoon.



Muista varata aikaa. Älä jatka seuraavaan vaiheeseen, ennen kuin lemmikkisi on varmasti tottunut kannen liikkeeseen.

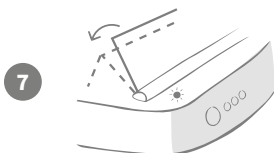

7

Kun lemmikkisi on tottunut liikkeeseen, paina jälleen Koulutustila-painiketta (🐾). Kansi sulkeutuu seuraavaan asentoon, ja takaosan merkkivalo vilkahtaa nyt kolme kertaa oranssina.



Jatka taas ruoka-automaatin käyttöä normaalisti, äläkä jatka seuraavaan vaiheeseen, ennen kuin lemmikkisi on tottunut tähän liikkeeseen.

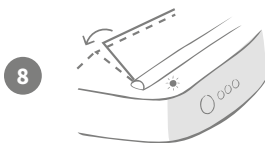

8

Lemmikkisi pitäisi olla nyt tyytyväinen kannen liikkeeseen, joten tässä viimeisessä koulutusvaiheessa kansi sulkeutuu vielä pidemmälle. Kuten aikaisemminkin, paina jälleen Koulutustila-painiketta (🐾). Kansi sulkeutuu lopulliseen asentoonsa, ja takaosan merkkivalo vilkahtaa nyt neljä kertaa oranssina.



9

Kun lemmikkisi on tottunut tähän lopulliseen asentoon, paina jälleen (🐾). Kansi sulkeutuu täysin, eikä takavallo enää vilku. Ruoka-automaatti on nyt kiinni ja päivittäisen käytön tilassa.



Voit poistua koulutustilasta milloin vain painamalla Koulutustila-painiketta (🐾) **viiden sekunnin ajan**.



Jos sinun on palattava edelliseen vaiheeseen, noudata yllä annettua vihjettä. Ruoka-automaatti poistuu koulutustilasta, ja prosessi voidaan aloittaa alusta.



Jos kannen sulkeutuminen lemmikin poistuttua laitteen äärestä vaikuttaa hermostuttavan lemmikkiä, voit säätää ennen kannen sulkemista kuluva odotusaikaa Sure Petcare -sovelluksessa.



Puhdistus ja huolto

SureFeedin mikrosirutetun lemmikin Connect-ruoka-automaatin pitäminen puhtaana on tärkeää sen luotettavan toiminnan kannalta.

Älä upota koko laitetta veteen tai pidä sitä juoksevan veden alla!

Vesi voi vahingoittaa ruoka-automaattia ja sen elektroniikkaa.

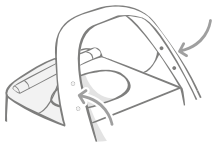
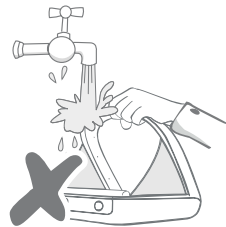

Varmista, että vanteen neljä mustaa pistettä pysyvät aina puhtaana.

Matto voidaan pyyhkiä puhtaaksi kostealla liinalla. **Älä pese laitteen osia astianpesukoneessa. Vain käsinpesu.**

Connect-ruoka-automaatin pohjassa on **puhdistusluukku**, joka helpottaa murujen tai roskan poistamista.

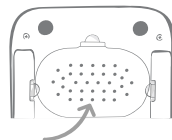

Kannen poistaminen puhdistamista varten

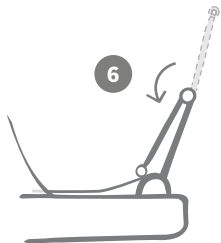

Käännä sitten yläpuolisko taakse siten, että se lepää kansiohjainten päällä.

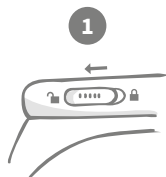

Siirrä kannen salpa avattuun asentoon.

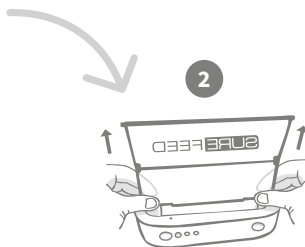

Paina painiketta (↕).
Kun kansi on auki, vedä sitä ylöspäin.

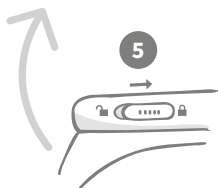

Siirrä kannen salpa suljettuun asentoon.

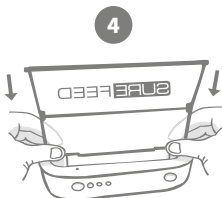

Laita kansi puhdistukseen jälkeen takaisin pitäen molemmat puoliskot pystysuunnassa. Varmista, että se on kunnolla paikallaan.

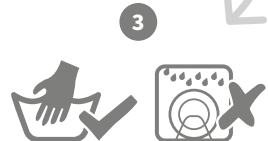

Vain käsinpesu.
Älä pese astianpesukoneessa.

Ruoka-automaatin puhtauden varmistaminen

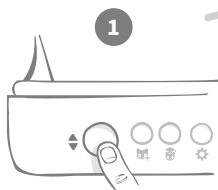

1
Paina avaus-/
sulkupainiketta (↕).

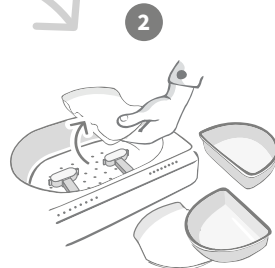

2
Poista kulhot, kulhojen tuet ja kansi -
katso edellinen sivu.



7
Kiinnitä kaikki osat takaisin paikalleen ja
varmista, että **kiinnitit ensimmäiseksi
puhdistusluukun.**

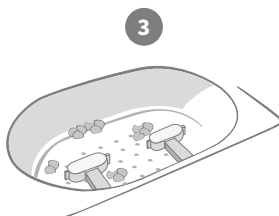

3
Punnitusvarsienv ympärille tarttuneet
jäämät voivat vaikuttaa ruoka-automaatin
toimintaan, joten ne on tärkeää pitää
puhtaana. **Älä käytä hankaavia
pesusieniä**, koska ne voivat vahingoittaa
ruoka-automaattia ja aiheuttaa
virheellistä toimintaa.

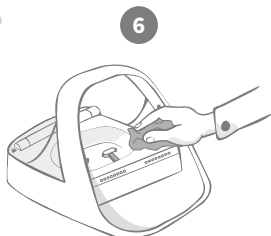

6
Varmista kostealla liinalla,
että ruoka-automaatin kaikki
pinnat ovat puhtaat. **Älä käytä
hankaavia puhdistusaineita.**

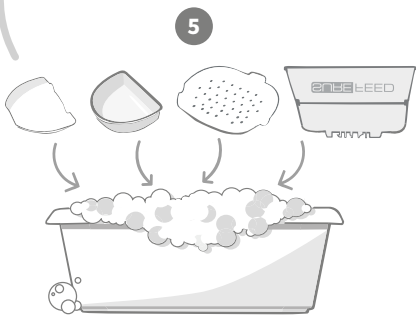

5
Pese kaikki irrotettavat osat käsin.
Älä pese niitä astianpesukoneessa.

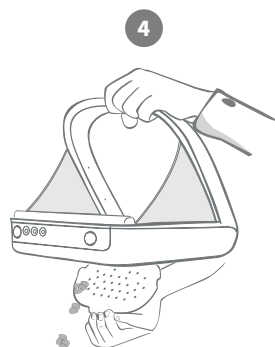

4
Pidä ruoka-automaattia roska-astian
yläpuolella, irrota puhdistusluukku
ja anna roskien pudota.



Ohje ja tuki

Mukautetut asetukset

Koska kaikki lemmikit eivät käyttäydy samalla tavalla, Connect-ruoka-automaatin toimintaa voidaan mukauttaa eri tavoin. Ruoka-automaatissa on mukautettuja asetuksia, joista on apua, jos lemmikit käyttävät laitetta odottamattomilla tai epätavallisilla tavoilla. Seuraavassa on joitakin esimerkkejä eläinten käyttäytymisestä, jonka aiheuttavat ongelmat voidaan ratkaista mukautetuilla asetuksilla:

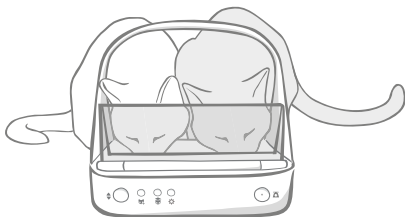

Työntyykö luvaton lemmikkisi syömään samalla luvallisen lemmikkisi kanssa?

Mukautettu asetus ratkaisee ongelman!

Varastaako luvaton lemmikki ruokaa toisen lemmikin ruoka-automaatista, kun se on koulutustilassa?

Mukautettu asetus ratkaisee ongelman!



Onko ovela luvaton lemmikki keksinyt, miten kannen sulkeutumisen voi estää?

Mukautettu asetus ratkaisee ongelman!

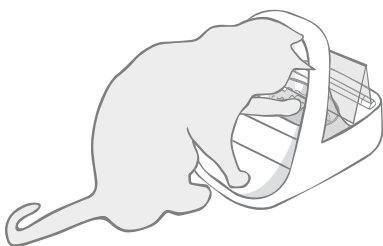

Yrittääkö luvaton lemmikki varastaa ruoka-automaatista takakautta ruokaa?

Lisävaruste ratkaisee ongelman!

Siirry osoitteeseen [surepetcare.com/accessories](https://www.surepetcare.com/accessories) ja tee haku sanoilla Rear Cover (takakansi).

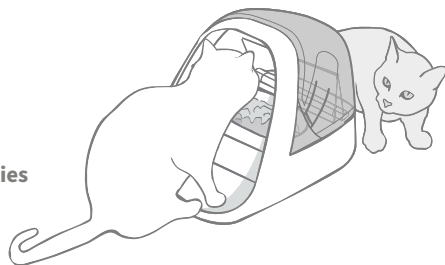

Pyydä lisätietoja mukautetuista asetuksista asiakaspalvelustamme – **yhteystiedot ovat takakannessa**. Tukiedustajamme osaa suositella tilanteeseen sopivinta mukautettua asetusta ja etämäärärittää sen laitteeseesi.

Keskitin

Punaisena vilkkuvat korvat

Keskittimen yhteys Connect-ruoka-automaattiin on katkennut.

- Jos näet, että **molemmat korvat vilkkuvat punaisena käyttöönoton aikana**, suorita tehdasetusten palauttaminen painamalla keskittimen pohjassa olevaa painiketta 10 sekunnin ajan.
- Jos näet, että **molemmat korvat vilkkuvat punaisena pitkään käyttöönoton jälkeen**, sammuta keskitin ja käynnistä se uudelleen. Irrota virtajohto pistorasiasta, odota 30 sekuntia ja kytke johto takaisin pistorasiaan. Jos korvat pysyvät vihreinä muutaman minuutin ajan, keskitin on muodostanut yhteyden.
- Voit myös kokeilla **keskittimen siirtämistä sivulla 205 annettujen ohjeiden mukaisesti**. Jos se ei auta, sinun on siirrettävä keskitin lähemmäs ruoka-automaattia. Katso ohjeet alta.
- Jos haluat siirtää keskittimen lähemmäs, kokeile yhdistää se reitittimeen pidemmällä Ethernet-kaapelilla.
- Jos se ei auta, suosittelemme **sähköverkon Ethernet-adapterin** hankkimista. Se kytketään normaaliin pistorasiaan, ja sen avulla voit yhdistää keskittimen internetiin lähempänä ruoka-automaattia.

Vuorotellen vilkkuvat korvat (punainen tai vihreä)

Keskittimellä on vaikeuksia muodostaa yhteyttä Sure Petcare -palvelimiin. Tämä voi johtua epävakaasta internet-yhteydestä.

- Irrota keskittimen virtajohto pistorasiasta, odota 30 sekuntia ja kytke johto takaisin pistorasiaan. Jos korvat pysyvät vihreinä muutaman minuutin ajan, keskitin on muodostanut yhteyden.
- Jos tämä ei ratkaise ongelmaa, tarkista, että internet-reitittimesi on kytketty virta ja että internet-yhteytesi toimii oikein muiden laitteiden kanssa.
- Jos se ei toimi, sammuta reititin, odota 30 sekuntia ja käynnistä se uudelleen.
- Jos reitittimesi toimii muiden laitteiden kanssa, kokeile kytkeä Ethernet-kaapeli uudelleen reitittimeen ja keskittimeen. Varmista, että liitin on työnnetty kokonaan sisään. Joskus se näyttää olevan kytketty, vaikkei olekaan.

Jos yhteysongelmat jatkuvat, käy osoitteessa [surepetcare.com/hub-connectivity](https://www.surepetcare.com/hub-connectivity)

Punaisena palavat korvat

Keskittimen laiteohjelmistoa päivitetään. Odota, että keskittimen korvat muuttuvat vihreiksi. Tämän ei pitäisi kestää kahta minuuttia pitempään. Kun päivitys on valmis, keskitin käynnistyy uudelleen. Tässä vaiheessa näet käynnistysvalot – **katso sivu 206**.

Hitaat ilmoitukset

Jos ilmoitusten näyttäminen sovelluksessa kestää joskus kauan, syynä on luultavasti se, että keskitin joutuu tekemään liikaa töitä pitääkseen yllä yhteyttä Connect-ruoka-automaattiin laitteeseen. Kokeile nopeuttaa viestien näyttämistä siirtämällä keskitin parempaan paikkaan **sivun 205** ohjeiden mukaisesti.

Mikrosirutetun lemmikin Connect-ruoka-automaatti

Jos ruoka-automaatissa on mekaanisia ongelmia, älä yritä korjata sitä itse. Ota sen sijaan yhteyttä asiakaspalvelutiimiimme – katso yhteystiedot **takakannesta**.

Kansi ei avaudu lemmikilleni

- Varmista, että vanteen neljä tunnistinta ovat puhtaita – **katso sivu 217**.
- Tarkista, että käytit hyvälaatuisia **alkaliparistoja** ja etteivät ne ole vähissä. Varmista, että paristojen + ja – osoittavat oikeaan suuntaan – **katso sivu 207**.
- Siirrä ruoka-automaatti pois metallisten tai sähkölaitteiden luota. Jos ruoka-automaatti ei vieläkään aukea ruokittavaksi tarkoitetulle lemmikille, jatka lukemista.
- Tarkista, ettei lähistöllä ole selvästi havaittavia sähköisten häiriöiden lähteitä, kuten viallisia, vilkkuvia valoja. Jos epäilet sähköhäiriötä, soita asiakaspalveluumme – **katso takakannesta lisätietoja**.
- Jos tämä ei ratkaise ongelmaa, keskustele eläinlääkärisi kanssa varmistaaksesi, että lemmikkisi mikrosiru toimii ja että se sijaitsee normaalissa paikassa. Jos se on siirtynyt merkittävästi, sen lukeminen ei välttämättä enää onnistu. Sillä välin voit käyttää mukana toimitettua Sure Petcare RFID -kaulapantamerkkiä. Kiinnitä kaulapantamerkki lemmikkisi kaulapantaan ja toista lemmikin lisäsvaiheet – **katso sivut 211**.

Lemmikkini ei halua käyttää ruoka-automaattia

- Toista koulutusprosessi ja anna lemmikillesi enemmän aikaa tottua kuhunkin vaiheeseen – **katso sivut 215–216**.
- Jos lemmikkisi suhtautuu ruoka-automaattiin yhä hyvin varautuneesti, kokeile noudattaa sivun **surepetcare.com/cautiouspet** ohjeita ja varo, ettet missään vaiheessa yritä pakottaa lemmikkiä syömään.
- Arvioi lemmikkisi ruokailuympäristöä. Lähestyvätkö ne aina kulhoa tietystä kulmasta? Huolestuttaako niitä olla selin oveen? Ei ole tiettyä suuntaa, johon ruoka-automaatti on asetettava, joten siirrä sitä mahdollisuuksien mukaan, jotta lemmikki tuntee olonsa mukavammaksi.
- Jos aika, joka odotetaan ennen kannen sulkemista lemmikin syötyä ja poistuttua, ei sovi lemmikille, voit säätää aikaa Sure Petcare -sovelluksessa.

Ruoka-automaatin kansi ei sulkeudu kokonaan

- Syyinä voivat olla ruoanjäämät, jotka tarttuvat kannen alle tai mekanismiin. Jotta kansi sulkeutuu asianmukaisesti, on tärkeää poistaa ruoanjäämät ruoka-automaatin pinnoilta – **katso sivut 217–218**.
- Varmista, että laite ei ole koulutustilassa. **Käy sivulla 215** saadaksesi lisätietoja toiminnasta koulutustilassa.

Annosilmäinvalot palavat, mutta kulho on tyhjä

Jos ruoka-automaattia avattaessa osa annosilmäinvaloista palaa vihreänä, vaikka kulhoissa ei ole enää ruokaa, laite on syytä nollata. Ratkaise ongelma muistamalla aina painaa nollauspainiketta ennen lemmikin ruoan vaihtamista – **katso sivut 213–214**.

Annosilmaisinvalot eivät reagoi

- Huomaa, että jos Sure Petcare -sovelluksessa ei ole asetettu annospainoa, annosilmaisinvalot eivät syty, kun ruokaa lisätään.
- Myös punnitusvarsien ympärille tarttuneet jäämät voivat vaikuttaa ruoka-automaatin toimintaan, joten varmista, että ne ovat puhtaat – **katso sivut 217–218**.

Toiset lemmikit varastavat ruokaa

- Jos ahneet lemmikit yrittävät varastaa ruokaa avoimesta ruoka-automaatista, kokeile nopeuttaa Sure Petcare -sovelluksessa kannen sulkeutumista sen jälkeen, kun lemmikki on lopettanut syömisen.
- Ongelmasi ratkaisemiseksi on mahdollisesti olemassa mukautettu asetus. Pyydä neuvoa ongelmaasi asiakaspalvelustamme – **yhteystiedot ovat takakannessa**.
- Jos ahnaat lemmikit onnistuvat varastamaan ruokaa ruoka-automaatin sivusta tai takaa (kun kansi on auki ja ruokittava lemmikki syö), valikoimaamme kuuluu moisen estävä takakansi. Lisätietoja on osoitteessa **surepetcare.com/accessories**.

Paristot kuluvat nopeasti

- Varmista, että ruoka-automaatti on puhdas ja että sen tunnistimet eivät ole liian peitossa – **katso sivu 217**.
- Varmista, että käytössä on laadukkaat paristot ja että ne on asetettu oikein paikalleen – **katso sivu 207**.
- Tarkista, ettei lähistöllä ole selvästi havaittavia sähköisten häiriöiden lähteitä, kuten viallisia, vilkkuvia valoja. Jos epäilet sähköhäiriötä, soita asiakaspalveluumme. Katso yhteystiedot **takakannesta**.

Monta ruoka-automaattia yhdessä taloudessa

- Jos sinulla tai lemmikeilläsi on vaikeuksia muistaa, mikä ruoka-automaatti kuuluu millekin lemmikille, kokeile käyttää erivärisiä kulhoja ja sijoita laitteet toisistaan eroaviin paikkoihin. Sen pitäisi ratkaista ongelma. Erivärisiä kulhoja ja mattoja myydään erikseen. Lisätietoja on osoitteessa **surepetcare.com/accessories**.

Tarvitsetko vielä apua?



- Jos yhteysongelmat jatkuvat, käy osoitteessa **surepetcare.com/hub-connectivity**.
- Löydät lisäohjeita, videoita ja asiakastukifoorumeita osoitteesta **surepetcare.com/support**.
- Jos sinulla on ongelmia Sure Petcare -sovelluksen käytössä, käy osoitteessa **surepetcare.com/apphelp**.

Voit myös ottaa yhteyttä asiakaspalveluumme. **Katso tarkemmat tiedot takakannesta.**



Takuu ja vastuuvapautuslauseke

Takuu: SureFeedin mikrosirutetun lemmikin Connect-ruoka-automaatilla on kolmen vuoden takuu ostopäivästä alkaen sillä edellytyksellä, että ostopäivä voidaan todistaa. Takuu rajoittuu vikoihin, joita on aiheutunut viallisista materiaaleista, osista tai valmistuksesta. Tätä takuuta ei sovelleta tuotteisiin, joiden vika on aiheutunut normaalista kulumisesta, väärinkäytöstä, laiminlyönnistä tai tahallista vahingosta. Mikäli osavika esiintyy viallisten osien tai valmistuksen vuoksi, osa vaihdetaan kustannuksitta vain takuujakson ajan. Valmistajan harkinnan mukaan vaihtotuote voidaan tarjota kustannuksitta vakavamman toimintahäiriön tapauksessa. Tämä ei vaikuta lakisäätöihin oikeuksiisi.

Vastuuvapautuslauseke: Mikrosirutetun lemmikin Connect-ruoka-automaatti ja sovellus ilmoittavat lemmikin ruoankulutuksen tunnistamalla lemmikin mikrosirutunnisteen ja punnitsemalla kulhon painon ennen ruokailua ja sen jälkeen. Useimmissa tapauksissa näin saadaan luotettavia tietoja lemmikin ruoankulutuksesta, mutta ruoka-automaatin odottamaton tai epätavallinen käyttö (esimerkiksi jos lemmikki poistaa kulhon tai leikkii ruoalla) voi johtaa epätarkkoihin tietoihin. Sure Petcare ei ota vastuuta vahingoista tai haitoista, joita voi aiheutua virheistä lemmikkien ruoankulutuksen ilmoittamisessa.

SureFeedin mikrosirutetun lemmikin Connect-ruoka-automaatin valikoivien pääsyominaisuuksien tarkoitus on minimoida se riski, että lemmikit pääsevät syömään toistensa ruokaa. Ei ole kuitenkaan mahdollista täysin taata kaikkien muiden lemmikkien poissaoloa kaikissa olosuhteissa. Siinä harvinaisessa tapauksessa, että luvaton lemmikki pääsee ruoka-automaatille, Sure Petcare ei voi ottaa vastuuta mahdollisista vahingoista tai haitoista.



Tuotteiden ja käytettyjen paristojen hävittäminen: Tämä kuvake osoittaa tuotteet, jotka ovat seuraavan lainsäädännön alaisia:

Sähkö- ja elektroniikkalaitte-romudirektiivin 2012/19/EU (WEEE-direktiivi) ja akku/paristodirektiivin 2006/66/EY (ja lisäyksen 2013/56/EU) mukaisesti kotitalouksilla on velvollisuus hävittää SER-tuotteet ja romuparistot, joiden käyttöikä on päättynyt, ympäristöllisesti vastuullisella tavalla. Ympäristövaikutusten vähentämiseksi niitä ei voi sijoittaa kotitalousjätteisiin, ja ne on kierrätettävä asianmukaisessa kierrätyslaitoksessa. Saat lisätietoja kierrätyksestä osoitteesta www.recycle-more.co.uk.

Varmista, että paristot vaihdetaan ennen paristossa tai pakkauksessa mainittua viimeistä käyttöpäivämäärää ja hävitetään turvallisesti ja asianmukaisesti.

Jos paristo vuotaa, pukeudu asianmukaisiin suojarusteisiin suojautuaksesi haitallisilta kemikaaleilta ennen paristojen hävittämistä ja vuotojen puhdistamista. Vältä pariston sisällön joutumista iholle puhdistaussasi vuotoa. Paristokemikaaleja ei saa päästää silmien lähelle tai niellä. Ota heti yhteyttä lääkäriin, jos näin tapahtuu.

Tavaramerkit: Google Play ja Google Play -logo ovat Google Inc:n tavaramerkkejä. Apple on Apple Inc:n tavaramerkki, joka on rekisteröity Yhdysvalloissa ja muissa maissa. App Store on Apple Inc:n palvelumerkki, joka on rekisteröity Yhdysvalloissa ja muissa maissa. IOS on Cison tavaramerkki tai rekisteröity tavaramerkki Yhdysvalloissa ja muissa maissa, ja sitä käytetään lisenssillä.



SURE[™]
PETCARE

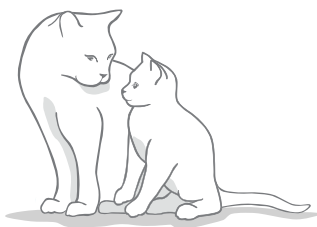

Välkommen till din nya foderautomat Connect med mikrochip

Tack för att du valt foderautomat Connect med mikrochip!

Systemet för foderautomaten Connect med mikrochip består av tre element som verkar tillsammans för att ge dig närhet till ditt husdjur och en inblick i dess matvanor.

Foderautomaten Connect med mikrochip är huvuddelen av systemet. Den känner igen antingen ditt husdjurs ID-mikrochip eller Sure Petcares RFID-halsbandsbricka (en ingår), och låter ditt husdjur komma åt sin mat medan andra djur hålls borta från den.

Hubben (säljs separat) är den anslutna delen i systemet. Den ansluter till ditt heminternet och kan kommunicera med både foderautomaten och Sure Petcare-appen.

Genom att använda **Sure Petcare-appen** kan du övervaka mängden mat som ditt husdjur äter och hur ofta det besöker foderautomaten. Appen låter dig också skicka en portionsvikt till foderautomaten så att du kan kontrollera mängden mat per portion.

Vad som ingår i förpackningen

Se till att du har alla dessa delar*

- 1 1 x foderautomat Connect med mikrochip
- 2 1 x enkel skål
- 3 2 x halva skålar
- 4 1 x matta
- 5 1 x hållare för enkel skål
- 6 2 x hållare för halva skålar
- 7 1 x Sure Petcare RFID-halsbandsbricka

*Batterier och hubb ingår inte

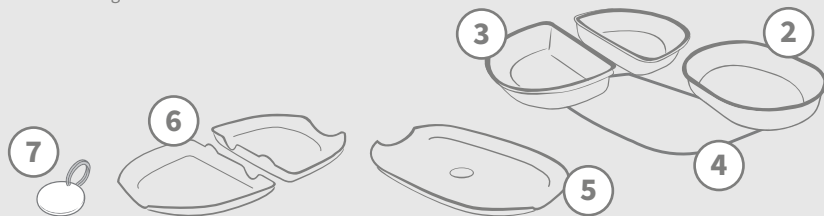
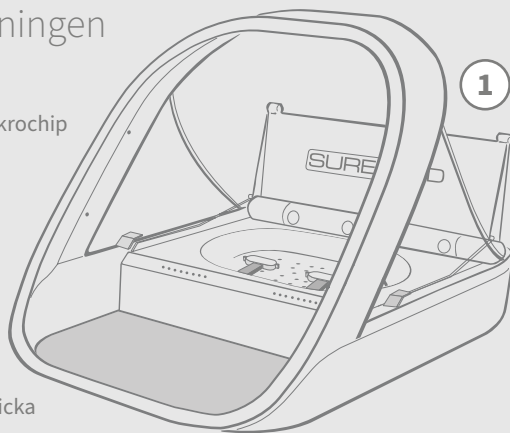

För att foderautomaten Connect med mikrochip ska fungera som ett anslutet system måste du köpa en tillhörande hubb. Besök surepetcare.com/hub för mer information om hur du köper en hubb.

Innehåll

Viktig information.....	228
Produktöversikt.....	230
Systemet foderautomat Connect med mikrochip	232
Hubb	
Konfigurera din hubb.....	233
Placering av hubben	234
Hubbljus	235
Foderautomat	
Batterier.....	236
Anslut din foderautomat.....	237
Knappar och lampor	238
Lägga till ditt husdjur till foderautomaten.....	240
Ställa in portioner	241
Fylla på och ersätta maten.....	242
Träningsläge	244
Rengöring och underhåll	246
Hjälp och support.....	248
Garanti och ansvarsfriskrivning.....	252



Viktig information



LÄS FÖLJANDE INFORMATION NOGGRANT OCH SPARA BRUKSANVISNINGEN.



Produkten är endast avsedd för **husdjur**.



Använd endast tillbehör från SureFeed för att säkerställa kompatibilitet: [surepetcare.com/accessories](https://www.surepetcare.com/accessories)



Se till att du har alla delar som är uppräknade på **sida 225**.



Placera inte foderautomaten på ställen där människor ofta passerar.



Foderautomaten är endast avsedd för **inomhusbruk**.



Foderautomaten får inte sänkas ner i vatten eller hållas under en kran.



Placera inte foderautomaten i kylan och lägg inte ispåsar i eller under den.



Placera inte foderautomaten på ställen som blir mycket varma.



Produkten behöver **4 stycken C-cellsbatterier** vilka ska sättas i och bytas ut med försiktighet. Blanda inte olika slags batterier och använd inte en blandning av nya och använda batterier. Ta ut batterierna om foderautomaten ska ställas undan och inte användas under en längre tid.

Du hittar **produktkoden** och **serienumret** för foderautomaten Connect med mikrochip på undersidan av produkten.

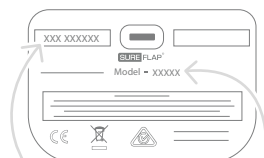

Serienummer

Produktkod

Säkerhetsvarningar

- Använd inte produkten om delar saknas, är skadade eller slitna.
- **Produkten består av små komponenter.** Lösa delar ska hållas utom räckhåll för små barn och husdjur för att undvika **risk för kvävning**.

Andra viktiga saker att ha i åtanke



HUSDJUR: Sure Petcare rekommenderar att SureFeeds foderautomat Connect med mikrochip används tillsammans med husdjurets implanterade mikrochip, men den kan även användas med Sure Petcares RFID-halsbandsbricka. Om du använder halsbandsbrickan ska den användas tillsammans med ett säkerhetshalsband som **har ett säkerhetsspänne** (endast katter). Sure Petcare tar inget ansvar för skador eller dödsfall som orsakas av husdjurets halsband.



MATTILLGÅNG: Sure Petcare tar inget ansvar för om obehöriga djur kommer åt mat till följd av oavsiktlig användning. Som ägare till produkten **tar du fullt ansvar för tillsyn av utdelning av mat** som skulle kunna skada andra husdjur vid oavsiktlig förtäring.



INGEN TIMERFUNKTION: Produkten har ingen timer och **inte heller andra tidsfunktioner**. Lämna därför inte ditt husdjur utan uppsikt eller förlita dig på att produkten ska förse dem mat under en längre tid – längre än 24 timmar för katter eller den genomsnittliga tiden mellan måltider för små hundar. **Produkten är ingen ersättning för att vara en ansvarsfull husdjursägare.**



BARN: Barn ska **inte tillåtas leka med SureFeeds foderautomat Connect med mikrochip**. Den är ingen leksak och bör inte behandlas som sådan. Produkten kan dock användas av barn som är åtta år och äldre samt av personer med nedsatt fysisk, sensorisk eller mental förmåga om de övervakas eller har fått anvisningar om hur produkten används på ett säkert sätt. De bör alltid vara medvetna om potentiella faror som användningen medför. Låt inte barn, oavsett ålder, rengöra produkten utan tillsyn.



GÖRA BARNSÄKER: I hushåll med barn är det viktigt att **ha SureFeeds foderautomat Connect med mikrochip i åtanke vid beslut gällande barnsäkerhet**. Missbrukas denna produkt av ett barn kan det leda till att barnet kommer i kontakt med potentiella faror. Av denna anledning bör små barn övervakas hela tiden när de befinner sig nära foderautomaten. Tänk också på att när foderautomaten är i **träningläge (se sida 243-244)** **kan ett barn fortfarande få tillgång till husdjurets mat.**



Produktöversikt

Systemet foderautomat Connect med mikrochip utgörs av tre huvudkomponenter:

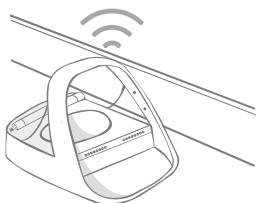

Foderautomat Connect
med mikrochip



Hubb



Sure Petcare-appen

Hubben är ansluten till internet via en ethernetkabel och övervakar aktiviteten för din foderautomat Connect med mikrochip. Den kommunicerar med både foderautomaten och Sure Petcare-appen så att du kan se uppdateringar i Sure Petcare-appen även när du inte är hemma!

Du kan också ställa in en portionsvikt i appen. När den är inställd kommer foderautomaten att vägleda dig när mat läggs till för att säkerställa att ditt husdjur får rätt portion.

Se sida 238 för mer information.

Skålar och skålhållare:

se sida 230.

Låslock:

se sida 237.

Sensorer: Fyra små prickar på bågens insida används för att detektera ditt husdjur.

Matta: Utformad för att samla upp matspill vilket underlättar rengöring av foderautomaten.

Bakre lysdiod:
se sida 238.

Knappar:
se sida 237.

Portionsindikatorlampor:
se sida 238.

Batterifack:
se sida 235.

Rengöringsskydd:
se sida 245.

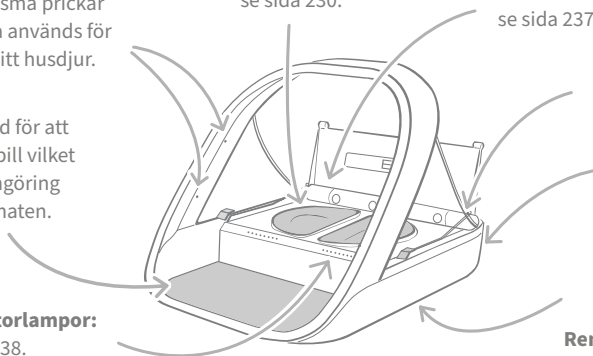

Hubbljus:
se sida 234.

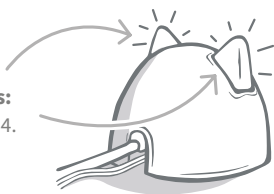

Ethernetport: att ansluta till internetroutern.

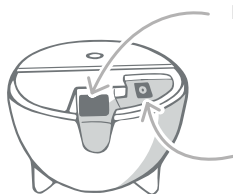

Strömförsörjning:
för att ansluta strömförsörjningskabeln.

Den övre kanten på SureFeeds skålar har en inbyggd tätning som hjälper till att hålla husdjurets mat färsk längre. Om du matar ditt husdjur med endast en typ av mat kan du använda en enkel skål, ger du dem både våt- och torrfoder är de halva skålarna perfekta!



Enkel skål - rymmer 250 gram vilket är tillräckligt för åtminstone 2 normala påsar med våtfoder.

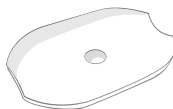

Hållare för enkel skål - är utformad att hålla den enkla skålen (inte de halva skålarna).

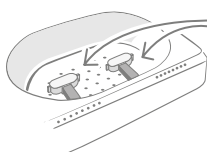

Vågarmar - designade för att hålla skålhållaren.



Halva skålar - skålarna rymmer 100 gram var för sig eller 200 gram tillsammans.



Hållare för halva skålar - var och en är utformad att hålla en halv skål (inte den enkla skålen).

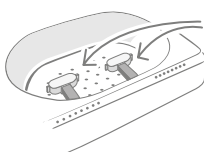

Vågarmar - designade för att hålla skålhållarna.

Lägg inte ditt husdjurs mat direkt på skålhållarna. Använd alltid skålarna för att säkerställa att foderautomaten fungerar korrekt.



SureFeeds delade skål är inte avsedd att användas med foderautomat Connect med mikrochip.

För att köpa fler skålar och mattor kan du fråga din Sure Petcare-återförsäljare eller besöka surepetcare.com.

Ge den en färglick



SureFeeds plastskålar och mattor finns i fyra olika färger: blått, grönt, rosa och grått.

Eller lägg till lite glans

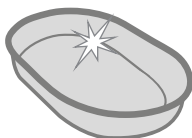

SureFeeds enkla skål finns även i rostfritt stål.



Diska inte skålarna i diskmaskin och kör dem inte i mikrovågsugn.



Handdiska skålarna före första användningen.



Systemet foderautomat Connect med mikrochip

Ladda ner den kostnadsfria Sure Petcare-appen nu

HÄMTA I
APP STORE

LADDA NED PÅ
GOOGLE PLAY



surepetcare.io



Få aviseringar när husdjuret äter från foderautomaten.



Håll koll på ditt husdjurs matintag och uppmärksamma beteendeförändringar.



Fördela maten noggrant för att kontrollera mängden som äts per portion.



Dela tillgången till ditt hushåll med familj och vänner.



Ladda ner **Sure Petcare-appen** och skapa ett konto. Du kommer att ombesöka ett 'hushåll' (ett anslutet nätverk som innehåller alla dina Sure Petcare-anslutna produkter och husdjur). Du kan bjuda in andra familjemedlemmar att gå med i ditt hushåll.

För att ladda ner appen måste din telefon eller surfplatta ha åtminstone **iOS 9** på **Apple** eller **4.4** på **Android**.



Om du hellre vill styra dina Sure Petcare-anslutna produkter från din dator kan du använda Sure Petcare-webbappen på **surepetcare.io**.

Du kommer att behöva den senaste versionen av **Safari**, **Chrome**, **Firefox** eller **Internet Explorer** på antingen **Mac OS X v10.9** (eller senare) eller **Windows 7** (eller senare).

Köp en Sure Petcare-hubb



För att foderautomaten Connect med mikrochip ska fungera med Sure Petcare-appen måste du köpa en tillhörande hubb. För mer information kan du besöka **surepetcare.com/hub**.



Konfigurera din hubb

När du väl har laddat ner Sure Petcare-appen måste du koppla in hubben och konfigurera den. När hubben har konfigurerats kommer du att ombes ansluta den till både foderautomaten och appen. Följ stegen nedan:

1

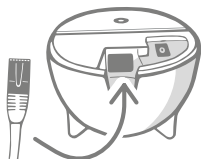

Anslut den ena änden av ethernetkabeln till basen på din hubb och den andra änden till en extra ethernetport på din router.

2

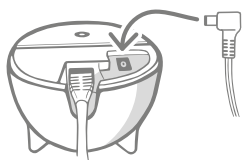

Sätt ihop strömförsörjningen och anslut den till ditt eluttag. Anslut den andra änden av kabeln till basen på din hubb.

3



Hubbens 'öron' börjar då att **växla rött och sedan grönt**. När båda öronen förblir helt gröna är hubben redo. Om öronen inte klarar av denna sekvens kan du **se sida 234** för mer information.

4



För att slutföra konfigurationen av systemet för foderautomaten Connect med mikrochip kommer du att behöva **följa de återstående stegen i Sure Petcare-appen**.



Din hubb kan få en uppdatering av programvara. Oroa dig inte om du ser **fasta röda ljus** under konfigurationen; hubben uppdaterar bara sin programvara. När detta är slutfört kommer hubben att startas om och du kommer att se ljussekvensen som beskrivs i steg 3.



Placering av hubben

Eftersom systemet för foderautomaten Connect med mikrochip kommunicerar trådlöst kan placeringen av hubben påverka dess prestanda.



Placera hubben minst 1 meter från marken (dvs. på ett bord som är så fritt som möjligt).

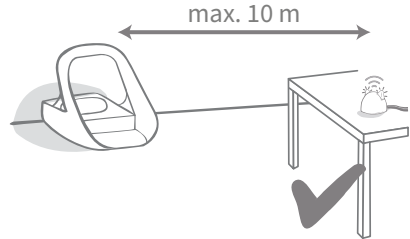

Försök att placera hubben så att den är i siktlinje med foderautomaten och inom en radie på 10 meter.

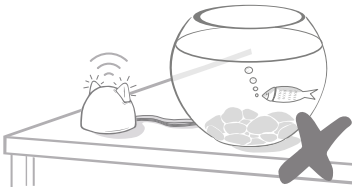

Undvik att placera hubben nära eller i siktlinje med stora mängder vatten (dvs. akvarium).

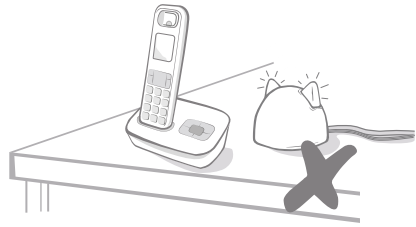

Håll hubben så långt borta som möjligt från eventuella störningskällor (dvs. digitala trådlösa telefoner, babymonitorer etc.).

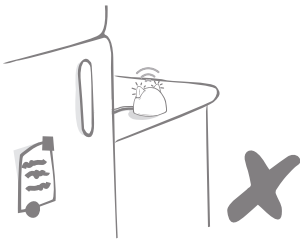

Se till att hubben inte är placerad bredvid några stora metallföremål (dvs. kylskåp).

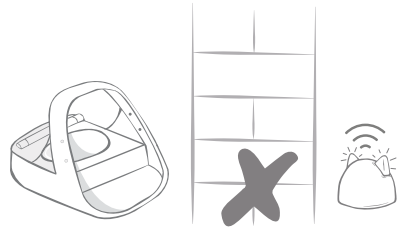

Undvik tjocka väggar mellan hubben och foderautomaten.



Din hubb kan ibland ha problem med anslutningen trots att du följer dessa tips. För ytterligare råd om hur du kan flytta hubben närmare foderautomaten Connect med mikrochip kan du besöka [surepetcare.com/hub-connectivity](https://www.surepetcare.com/hub-connectivity).



Om hubben förlorar anslutningen till internet av någon anledning kommer din foderautomat Connect med mikrochip fortsätta att fungera som normalt och behålla sina inställningar.



Hubbljus

Hubben indikerar sitt nuvarande tillstånd med ljusen i öronen. Olika färgade ljussekvenser betyder olika saker.

Installationsljus

Varje gång hubben slår på eller försöker ansluta till andra delar av systemet ser du installationsljusen:

- 1** öronen **växlar rött** ett tag,

- 2** sedan **växlar de grönt**,

- 3** när du ser att öronen **blinker orange** och sedan lyser med ett **fast grönt ljus** är hubben ansluten.



Gröna öron

Gröna öron betyder att hubben fungerar korrekt. Se nedan för information om vad varje ljussekvens betyder.

Båda öronen lyser med ett fast grönt ljus – Hubben är på och ansluten och fungerar som den ska.

Öronen växlar grönt – Hubben återansluter till våra servrar.

Röda öron

Båda öronen lyser med ett fast rött ljus – Hubben genomgår en uppdatering av programvara. Ha tålamod, hubben kommer snart att starta om och fortsätta som vanligt.

Båda öronen blinkar rött – Hubben har förlorat anslutningen till foderautomaten och försöker återansluta.

Öronen växlar rött – Hubben har problem med att ansluta till internet och/eller servrarna.

i Se sida 248 för information om hur du diagnosticerar dessa problem.



Batterier

Använd alltid **4 stycken 1,5 V alkaliska C-cellsbatterier av god kvalitet**. Detta säkerställer att din foderautomat Connect med mikrochip fungerar så väl som möjligt. **Denna produkt är INTE utformad för att användas med laddningsbara batterier.** För att sätta i eller byta batterier, följ stegen nedan:



Det finns ett ljus nära baksidan av foderautomaten. Om batterierna är låga eller har satts in fel kommer detta ljus att blinka rött var femte sekund.

1

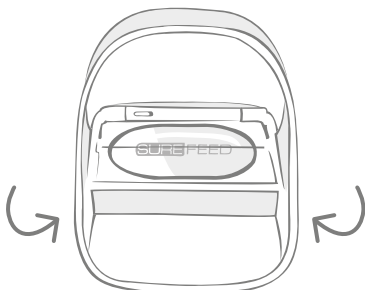

Vänd foderautomaten upp och ner för att komma åt batterifacken.

2

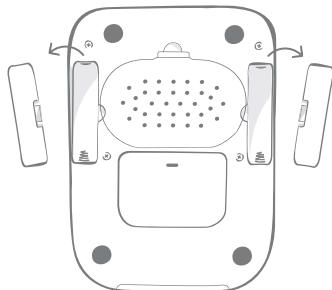

Öppna batteriluckorna.

3

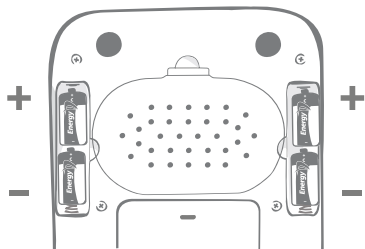

Sätt i batterierna. Se till att plus- och minussymbolerna på batterierna överensstämmer med symbolerna på foderautomaten.

4

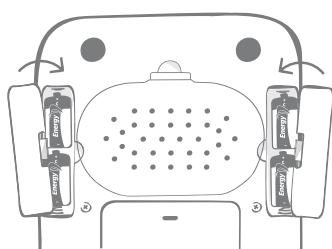

Sätt tillbaka batteriluckorna.



När du har programmerat in ditt husdjurs ID-mikrochip i foderautomaten kommer det att lagras permanent i dess minne. Detta innebär att även när du byter batterier kommer foderautomaten fortfarande att känna igen ditt behöriga husdjur.



Anslut din foderautomat

För att slutföra konfigurationen av det anslutna systemet måste du ansluta foderautomaten Connect med mikrochip till hushållet.

1

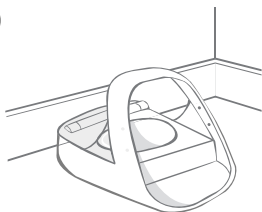

Placera foderautomaten på den avsedda platsen. Detta är för att säkerställa att den kan kommunicera med hubben.

2



I Sure PetCare-appen väljer du '**Lägg till produkt**'.

3



Hubben kommer att gå i anslutningsläge och dess öron kommer att blinka grönt.

4

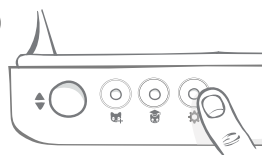

Tryck en gång på inställningsknappen '⚙️' på foderautomaten. Öronlysdioden kommer att lysa upp grönt.

5

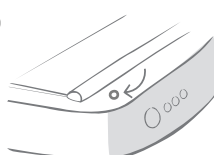

När foderautomaten är ansluten slöcknar lysdioden och hubben slutar att blinka.

i

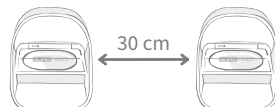

Om du vill ansluta fler foderautomater kan du enkelt göra det i appen.

Lägga till en foderautomat till ditt nuvarande hushåll



Du kan lägga till en foderautomat Connect med mikrochip till ditt befintliga Sure PetCare-hushåll via appen. Gå till hushållsavsnittet och följ instruktionerna ovan.

Du kan också tilldela ditt husdjurs ID-mikrochip på distans via appen. Detta betyder att du inte behöver lägga till dem manuellt. Att tillföra husdjur med hjälp av godis kan dock uppmuntra dem till att använda den nya produkten. **Se sida 239** för mer information om att tillföra husdjur.



Knappar och lampor

Knappar

Det finns fem knappar på foderautomaten. Dessa kan hittas på baksidan av produkten:

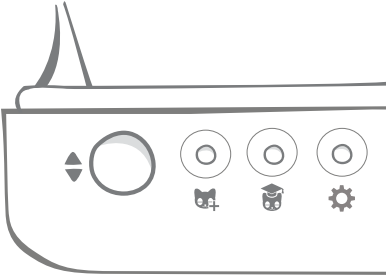

Öppna/stäng-knappen - öppnar och stänger locket så att du kan komma åt skålen/skålarna.



Lägg till ett husdjur-knappen - används för att lägga till ditt husdjurens ID-mikrochip till foderautomaten - **se sida 239**.



Träningslägesknappen - används för att aktivera träningsläget som lär ditt djur att använda foderautomaten - **se sida 243-244**.



Inställningsknappen - används för att ansluta foderautomaten och hubben - **se sida 236**.



Nollställningsknappen - används för att kalibrera foderautomaten och se till att du ger rätt mängd mat - **se sida 241**. Den här knappen kommer att nollställa **båda sidorna av foderautomaten, oavsett om du använder den enkla skålen eller de halva skålarna**.



Om du använder **halva skålar** och vill nollställa dem själv kan du göra det med **Sure Petcare-appen**.

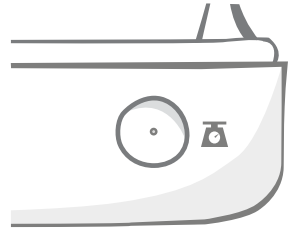

Locklås



Låst - detta innebär att du inte kan ta av locket från foderautomaten.



Olåst - du kan ta av locket när det är i öppet läge.

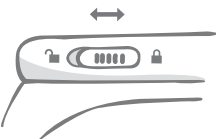
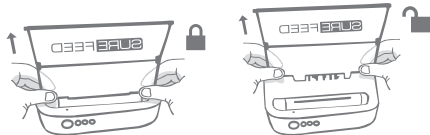

Locket bör alltid **vara låst** och endast låsas upp när det ska tas av för rengöring. Detta är så att du kan stoppa listiga obehöriga husdjur från att försöka få bort locket och komma åt maten. **Var medveten om att detta inte hindrar locket från att öppnas.**

Bakre lysdiod

Fast grönt ljus. Det gröna ljuset tänds varje gång ett behörigt husdjur äter från foderautomaten.

Blinkande grönt ljus. Foderautomaten är i läget 'Lägg till ett husdjur' - **se sida 239**. Ljuset kommer att fortsätta blinka tills ett mikrochip har lagts till eller du har gått ur läget.

Blinkande orange ljus. Foderautomaten är i träningsläge - **se sida 243-244**. Antalet blinkningar avser träningsstadiet.

Blinkande rött ljus. Batterierna börjar bli låga.

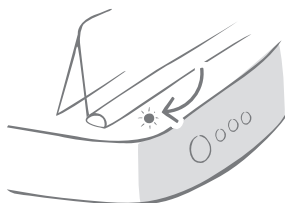

Portionsindikatorlampor

Om du har ställt in en portionsvikt i Sure Petcare-appen kommer lamporna på framsidan av foderautomaten att ge vägledning när du lägger till mat.

Portionsindikatorlamporna representerar mängden mat du har lagt till så att du kan se till att ditt husdjur får rätt portion.

För mer information om fördelarna med korrekt portionsfördelning kan du **se sida 240**.

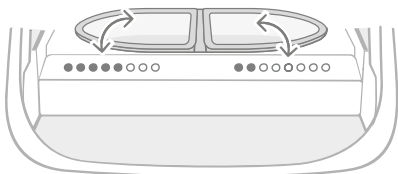
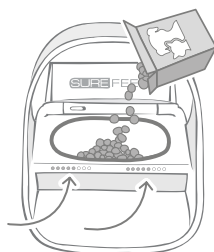

Använda halva skålar

Ljusen på foderautomatens högra sida motsvarar skålen till höger och detsamma gäller för vänster. Ljusen lyser upp när mat läggs till på varje sida.

Använda en enkel skål

Båda ljusen lyser upp samtidigt när mat läggs till i den enkla skålen.

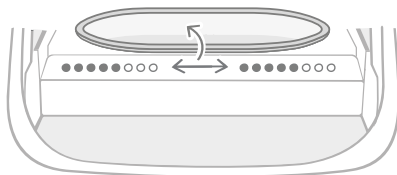

Om du vill byta från de halva skålarna till en enkel skål och vice versa måste du göra ändringen via Sure Petcare-appen.



Om du inte har ställt in en portionsvikt i appen lyser ljusen inte upp när det läggs till mat i foderautomaten.



Lägga till ditt husdjur till foderautomaten

När du lägger till ditt husdjurs ID-mikrochip i foderautomaten Connect med mikrochip ska du se till att alla andra husdjur och eventuella onödiga halsbandsbrickor hålls undan.

1

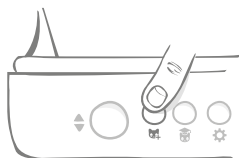

Tryck på knappen 'Lägg till ett husdjur' (🐱) på baksidan av foderautomaten.

2

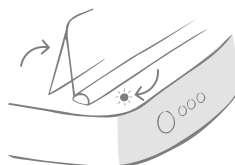

Locket öppnas och den bakre lysdioden blinkar grönt en gång per sekund.

3

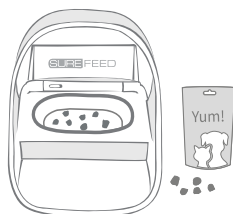

Placera mat/godis i skålen och ställ foderautomaten där du brukar mata husdjuret.

4

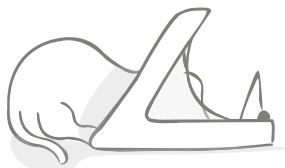

Medan ditt husdjur äter skannar foderautomaten dess ID-mikrochip. När ID:et har lagts till **slutar lysdioden att blinka** (men förblir tänd).

5

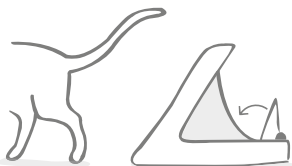

När ditt husdjur går iväg stängs locket och den gröna lysdioden slocknar. Husdjurets ID-mikrochip är nu sparad permanent.

i



Vid behov kan du när som helst avbryta läget 'Lägg till ett husdjur' genom att trycka på knappen 'Lägg till ett husdjur' (🐱) en gång till.



För att programmera in husdjurets ID-mikrochip måste sensorerna i foderautomatens båge upptäcka husdjuret. Därför är det viktigt att husdjuret för huvudet genom bågen för att äta.



För att programmera in Sure Petcares RFID-halsbandsbricka ska du följa stegen ovan men hålla halsbandsbrickan i bågen. Se till att du inte bär något metallsmykke när du programmerar in en halsbandsbricka.



Om du redan har ett husdjur i ditt Sure Petcare-hushåll är det möjligt att tilldela dem till foderautomaten. Gå till hushållsavsnittet i appen. Om du lägger till fel husdjur av misstag kan du alltid korrigerat det här.



Ställa in portioner

Foderautomaten Connect med mikrochip övervakar inte bara när och vad ditt husdjur har ätit - den hjälper dig också att mata ditt husdjur med exakta portioner.

Varför ska du portionera ut ditt husdjurs mat?

Skulle ditt husdjur må bra av att gå ner lite i vikt? Genom att ställa in en portionsvikt kan du se till att du inte ger det för mycket mat av misstag varje dag. Varje tugga räknas!

Möjligheten att väga upp portioner av mat direkt i foderautomaten gör det snabbare, enklare och smidigare att se till att ditt husdjur äter rätt mängd.

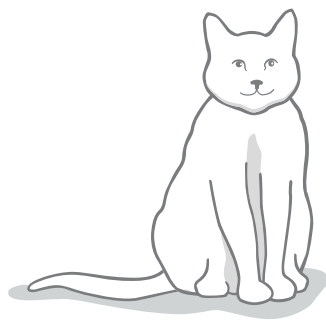

Hur mycket bör du mata ditt husdjur?

Det kan vara svårt att veta vad som är rätt mängd för ditt husdjur, och särskilt när det finns så många valmöjligheter. Vi rekommenderar att du rådgör med din veterinär eller djurhälsorådgivare för att se vad de rekommenderar.

Alternativt kan du hålla dig till riktlinjerna som ges på förpackningen av husdjursmatstillverkaren. Detta är vanligtvis en bra guide för genomsnittliga, friska husdjur.

Hur du ställer in portionsvikten i appen

Du kan ställa in portionsvikten med Sure Petcare-appen. När det är inställt skickas denna mängd till foderautomaten så att den vet hur mycket mat du vill ge ditt husdjur per portion.

Portionsindikatorlamporna på foderautomaten kommer sedan att vägleda dig när mat läggs till för att säkerställa att rätt portion ges. Ljusen representerar mängden mat som lagts till. **Se sida 242** för mer information.





Fylla på och ersätta maten

Det är viktigt att byta ut ditt husdjurs mat dagligen, inte bara för att se till att dina husdjur förblir glada och friska utan även för att hålla foderautomaten hel och ren.

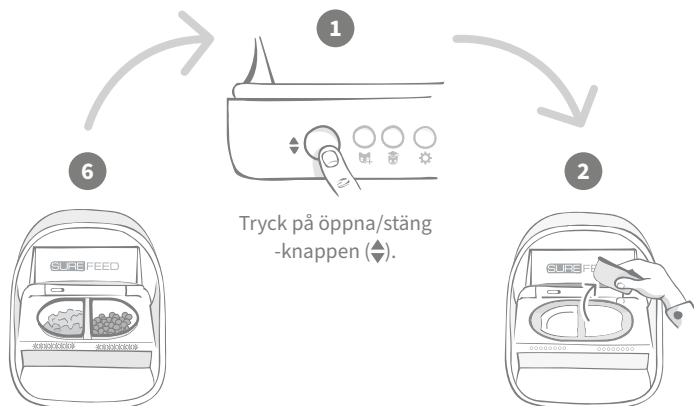

Tryck på öppna/stäng
-knappen (◊).

När alla ljus blinkar grönt har du fyllt
skålarna med fulla portioner.

Ta bort de smutsiga skålarna och spill.
Rengör dem eller byt ut dem till rena skålar.

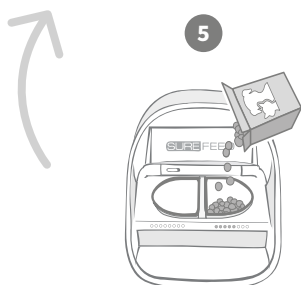

Efter nollställningen av ljussekvensen
kan du börja fylla skålarna.

Portionsindikatorlamporna lyser upp för att
visa mängden mat i varje skål - se nästa sida.

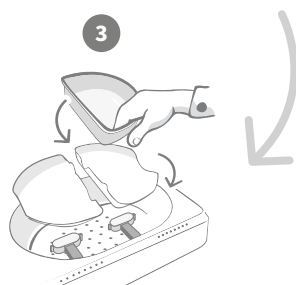

Se till att motsvarande hållare för enkel eller
för halva skålar sitter korrekt på vågarmarna
och **placera en tom skål ovanpå**.

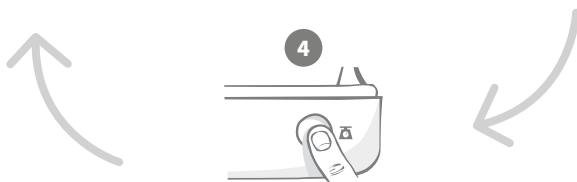

**Tryck på nollställningsknappen, innan du fyller på
skålarna**, för att se till att du ger ditt husdjur en full portion.
Kom ihåg att om du trycker på den här knappen nollställer
du **foderautomatens båda sidor** - se sida 237.

Portionsindikatorlampor



Ljusekvens för nollställning:

Fallande gröna ljus från höger till vänster visas när du trycker på nollställningsknappen.



Lägga till mat:

När mat läggs till kommer portionsindikatorlamporna att lysa grönt, med ökning från vänster till höger. Ljusen motsvarar mängden mat i skålen. Du måste fortsätta lägga till mat tills alla ljusen blinkar.



Nå portionsvikten:

När du är inom +/- 1 gram av portionsvikten kommer ljusen att **blinka grönt**. Om ljusen inte blinkar är portionen inte helt full.



Fylla på för mycket:

Om du lägger till mer än portionsvikten i skålen varnar de **röda ljusen** om hur mycket du har överfyllt den. Ta bara bort lite av maten tills du ser de blinkande gröna ljusen.



Var medveten om att om du inte har ställt in en portionsvikt i appen kommer portionsindikatorlamporna **inte att lysa upp** när mat läggs till i foderautomaten.

Mat kvar i skålen?

Om det fortfarande finns mat kvar i skålen när det är middagstid behöver du inte trycka på nollställningsknappen; lägg bara till mer mat i foderautomaten så låter den dig lägga till en ny portion med befintlig mat i skålen. Portionsindikatorlampan gör det möjligt att lägga till en full portionsmängd och indikerar detta.

1

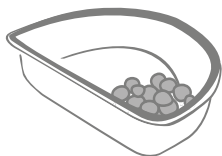

När du öppnar locket blinkar några ljus för att indikera att foderautomaten vet att det finns lite mat kvar i skålen. Alla ljus försvinner sedan så att du kan lägga till en ny färsk portion ovanpå den återstående maten.

2

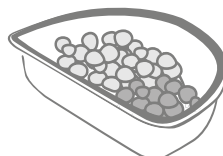

Fyll på skålen tills alla portionsindikatorlampor blinkar grönt.



Träningsläge

(lärt ditt husdjur att använda foderautomaten)



När du öppnar locket med knappen öppna/stäng blinkar den orangea träningslampan rött för att visa dig att öppna/stäng-knappen har tryckts in och att den är i öppet läge. Träningslampan återgår till orange när du trycker på knappen öppna/stäng när du har lagt till matportionen. **Om du inte trycker på knappen öppna/stäng kommer portionsindikatorlamporna inte att aktiveras och systemet kommer inte att kunna identifiera att du lägger till mat.**

DEL 1 - Bekanta ditt husdjur med foderautomaten

Vissa husdjur kan behöva lite tid för att vänja sig vid sin nya foderautomat. Träningsläget låter dig långsamt öka hur mycket locket stänger sig och gör att husdjuret gradvis kan känna sig säkert med sin nya matskål. Det kan ta ett tag, men ha tålamod och gå inte vidare till **DEL 2** innan ditt husdjur verkar känna sig bekvämt.

1

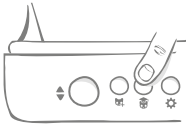

Medan locket är stängt trycker du en gång på knappen 'Träningsläge' (🐾) på baksidan av foderautomaten. Locket kommer att öppnas och den bakre lysdioden blinkar orange (med några få sekunders mellanrum).

2

Fyll skålen med ditt husdjurs favoritmat och ställ enheten där det brukar äta eller känner sig bekvämt att äta.

3



Under det första steget av att lära ditt husdjur att äta från foderautomaten **kommer locket inte att stängas** efter att det har ätit klart.



Kom ihåg att låta det ta sin tid och låt ditt husdjur vänja sig vid den nya skålen. När det är nöjt, gå vidare till DEL 2.

DEL 2 - Öka locket rörelser

Öka långsamt locket rörelse så att ditt husdjur vänjer sig vid det i tre steg. Ha tålamod och stressa inte för att uppnå bästa resultat och ditt husdjurs välmående. Mängden tid som krävs för varje steg skiljer sig åt för varje husdjur (dagar/veckor), men vi rekommenderar att låta varje steg ta några dagar.

4

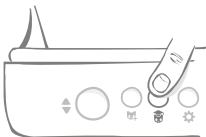

Börja öka hur mycket locket rör sig genom att trycka på knappen 'Träningsläge' (🐾) igen. Locket stänger sig lite och den bakre lysdioden blinkar orange två gånger.

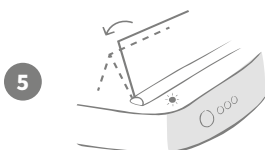

När ditt husdjur äter från skålen kommer locket att öppnas helt. När det har ätit klart stängs locket något.



Låt ditt husdjur vänja sig vid lockets nya rörelser. När du behöver ersätta maten gör du som vanligt - **se sida 241**. Efter att du ersatt maten ska du se till att trycka på knappen öppna/stäng (◊) för att stänga locket till dess träningsposition.



Kom ihåg att ha tålmod. Gå inte vidare till nästa steg förrän ditt husdjur har vant sig vid hur locket rör sig.

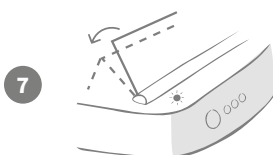

När ditt husdjur har vant sig vid hur locket rör sig trycker du på knappen 'Träningsläge' (⌘) igen. Locket kommer att stängas ytterligare en bit och den bakre lysdioden kommer att blinka orange 3 gånger.



Fortsätt återigen att använda foderautomaten som vanligt och gå inte vidare till nästa steg förrän ditt husdjur har vant sig vid hur locket rör sig.

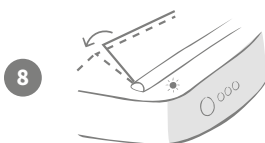

Ditt husdjur bör nu ha vant sig vid hur locket rör sig så i det sista steget av träningen stängs locket ännu mer. Tryck på knappen 'Träningsläge' (⌘) igen. Locket kommer att stängas till sin sista position och den bakre lysdioden kommer att blinka orange 4 gånger.



När ditt husdjur har vant sig vid den sista positionen trycker du på (⌘) igen. Locket stängs helt och den bakre lysdioden slutar blinka. Foderautomaten är nu stängd och i sitt dagliga användningsläge.



Du kan när som helst avsluta träningsläget genom att hålla inne knappen 'Träningsläge' (⌘) i **5 sekunder**.



Om du behöver backa ett steg, följ tipset ovan. Detta avslutar träningsläget för foderautomaten och du kan sedan starta om processen från början.



Om ditt husdjur verkar nervöst då locket stängs efter att det gått iväg från foderautomaten kan du i Sure Petcare-appen justera hur lång tid det tar innan locket stängs.



Rengöring och underhåll

Det är viktigt att hålla din foderautomat Connect med mikrochip ren så att den fungerar som den ska. **Sänk INTE ner hela enheten i vatten eller håll den under kranen! Vatten kan skada foderautomaten och dess elektronik.**

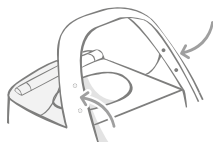

Se till att de fyra svarta prickarna på bågen alltid är rena. Mattan kan torkas ren med en fuktig trasa. **Lägg inte in någon del i diskmaskinen. Endast handtvätt.**

Foderautomaten Connect med mikrochip har ett **rengöringsskydd** på basen som gör det lättare att ta bort smulor eller skräp.

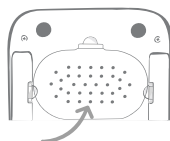

Hur du tar av locket för att rengöra det

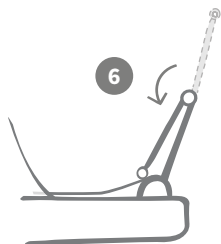

Vänd därefter den övre halvan av locket bakåt så att den vilar på ledskenorna.

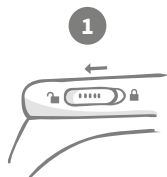

Skjut lockläsreglaget till olåst läge.

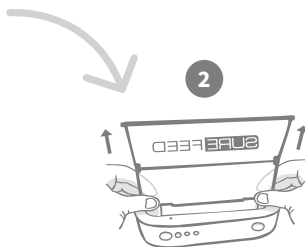

Tryck på knappen (◆). När locket är öppet lyfter du det uppåt.

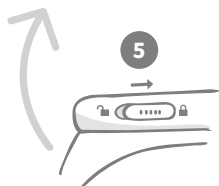

Skjut lockläsreglaget tillbaka till låst läge.



Sätt tillbaka locket med båda halvorna raka efter att du rengjort det. Se till att det sätts fast ordentligt.



Endast handtvätt. Diska **inte** i diskmaskinen.

Hur du säkerställer att din foderautomat är ren

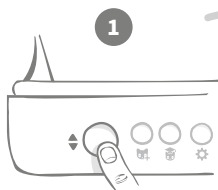

Tryck på öppna/stäng-knappen (◄).

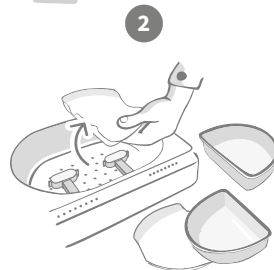

Ta bort skålarna, skålhållarna och locket - se föregående sida.



Sätt tillbaka alla delar igen och se till att **sätta fast rengöringsskyddet först.**

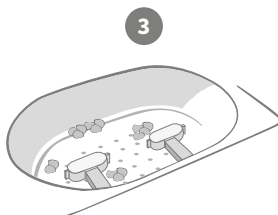

Skräp som fastnat på vågarmarna kan påverka foderautomatens prestanda, så det är väldigt viktigt att se till att den är ren. **Använd inte slipande svampar** eftersom de kan skada foderautomaten och påverka den så att den inte fungerar korrekt.

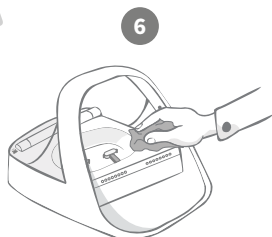

Använd en fuktig trasa för att se till att foderautomatens alla ytor är rena. **Använd inte slipande rengöringsprodukter.**

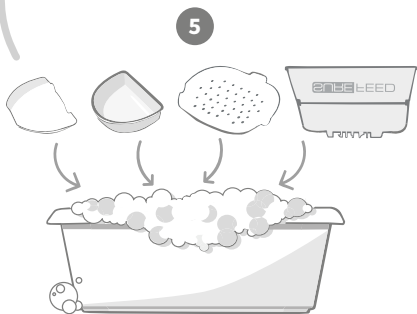

Handtvätta alla avtagbara delar.
Diska dem inte i diskmaskinen.

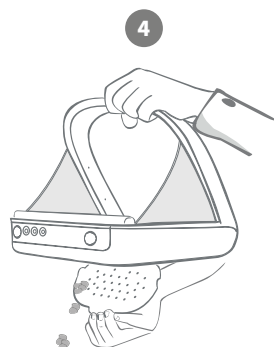

Håll foderautomaten ovanför soptunnan, ta bort rengöringsskyddet och låt skräpet falla ut.



Hjälp och support

Anpassade inställningar

Vi förstår att inte alla husdjur betar sig på samma sätt, så vi har designat foderautomat Connect med mikrochip med detta i åtanke. Foderautomaten innehåller en mängd anpassade inställningar utformade för att hjälpa om dina husdjur använder den på oväntade eller ovanliga sätt. Nedan är bara några exempel på djurbeteenden som de anpassade inställningarna kan komma till rätta med:

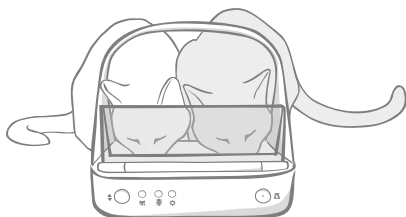

Trycker sig ditt obehöriga husdjur fram för att äta samtidigt som ditt behöriga husdjur?

Vi har en anpassad inställning för det!

Tycker ditt obehöriga husdjur om att stjäla mat från ett annat husdjurs foderautomat när den är i träningsläge?

Vi har en anpassad inställning för det!

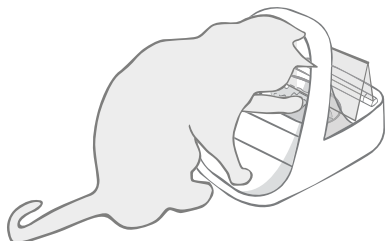

Har ditt listiga husdjur listat ut hur det stoppar locket från att stängas?

Vi har en anpassad inställning för det!

Försöker ditt obehöriga husdjur stjäla mat från foderautomatens bakre sida?

Vi har ett tillbehör för det!

Gå till [surepetcare.com/accessories](https://www.surepetcare.com/accessories) och leta efter baksideskyddet.

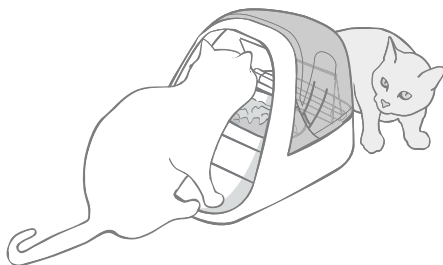

Vänligen kontakta vårt kundtjänstteam för att diskutera anpassade inställningar - **se bakskyddet för information**. De kommer att kunna rekommendera den lämpligaste anpassade inställningen för din situation och ställa in den för dig på distans.

Hubben

Röda blinkande öron

Hubben har förlorat anslutningen till foderautomat Connect med mikrochip.

- Om du ser att **båda öronen blinkar rött under installationen** bör du utföra en fabriksåterställning genom att trycka på knappen på hubbens bas i 10 sekunder.
- Om du ser att **båda öronen blinkar rött under en längre tid efter installationen** kan du prova att starta om hubben. Stäng av strömmen vid uttaget, låt vara i 30 sekunder och slå sedan på den igen. Om öronen lyser med ett fast grönt ljus i några minuter har hubben återanslutit.
- Du kan också prova att **flytta hubben** enligt de råd som ges på **sida 233**. Om detta inte fungerar måste du flytta hubben närmare foderautomaten - se nedan.
- För att flytta hubben närmare kan du försöka ansluta den till din router med en längre ethernetkabel.
- Om ovanstående inte fungerar rekommenderar vi att du köper en **'over power'-ethernetadapter**. Denna kommer att kunna anslutas till ett normalt eluttag och låter dig ansluta hubben till internet närmare foderautomaten.

Växlande blinkande öron (rött eller grönt)

Hubben har problem med att ansluta till Sure Petcare-servrarna. Detta kan bero på en opålitlig internetanslutning.

- Prova att starta om hubben genom att stänga av strömmen vid uttaget, vänta i 30 sekunder och sedan slå på den igen. Om öronen lyser med ett fast grönt ljus i några minuter har hubben återanslutit.
- Om ovanstående inte fungerar ska du kontrollera att din internetrouter är på och att internetanslutningen fungerar korrekt för andra enheter.
- Om det inte finns någon anslutning för andra enheter ska du prova att stänga av routern, vänta i 30 sekunder och sedan slå på den igen.
- Om routern fungerar för andra enheter ska du försöka att återansluta ethernetkabeln till routern och hubben. Se till att den är intryckt hela vägen eftersom det kan se ut som att den är ansluten när den inte är det.

Om du fortsätter ha problem med anslutningen kan du besöka: [surepetcare.com/hub-connectivity](https://www.surepetcare.com/hub-connectivity).

Fasta röda öron

Hubben genomgår en uppdatering av fast programvara. Ha tålamod och vänta tills hubbens öron blir gröna. Detta bör inte ta längre än två minuter. När uppdateringen av den fasta programvaran är klar kommer hubben att behöva starta om. I detta skede ser du installationsljussekvensen - **se sida 234**.

Långsamma aviseringar

Om du tycker att vissa meddelanden dyker upp långsamt i appen beror det troligen på att hubben har svårigheter med att ansluta till foderautomaten Connect med mikrochip. För att förbättra leveranstiden för meddelandena kan du försöka flytta hubben till en bättre plats enligt råden på **sida 233**.

Foderautomat Connect med mikrochip

Om foderautomaten har mekaniska problem ska du inte försöka att åtgärda dem själv. Kontakta istället vårt trevliga kundtjänstteam - se **bakskyddet** för kontaktuppgifter.

Foderautomaten öppnas inte för mitt husdjur

- Se till att de fyra sensorerna inuti bågen är rena - **se sida 245**.
- Kontrollera att du använder **alkaliska** batterier av hög kvalitet och att de inte håller på att ta slut. Se till att plus- och minusymbolerna på batterierna är i rätt riktning - **se sida 235**.
- Flytta foderautomaten så att den inte står nära några metall- eller elapparater. Fortsätt att läsa om foderautomaten fortfarande inte öppnar för ditt behöriga husdjur.
- Kontrollera att det inte finns några uppenbara källor till elektriskt brus i området, såsom blinkande lampor etc. Ring vårt kundtjänstteam om du misstänker att så är fallet. **Se bakskyddet för mer information**.
- Om ovanstående inte fungerar ska du be din veterinär att kontrollera att ditt husdjurs chip fungerar och att det ligger där det ska. Om det har flyttat på sig mycket har det blivit svårt att läsa. Under tiden kan du använda medföljande Sure Petcares RFID-halsbandsbricka. Fäst brickan på ditt husdjurs halsband och upprepa processen 'Lägg till ett husdjur' - **se sidorna 239**.

Mitt husdjur tycker inte om att använda foderautomaten

- Upprepa träningen och ge ditt husdjur mer tid att vänja sig vid varje steg - **se sida 243-244**.
- Om ditt husdjur fortfarande är nervöst nära foderautomaten kan du prova att upprepa stegen på **surepetcare.com/cautiouspet**, utan att någonsin tvinga husdjuret att äta från foderautomaten.
- Gör en bedömning av ditt husdjurs matplats. Närmar det sig alltid sin skål från samma riktning? Tycker det inte om att ha ryggen vänd mot dörren? Foderautomaten måste inte vara vänd i någon särskild riktning, så om det är möjligt kan du prova att vrida på den om det hjälper ditt husdjur att känna sig bekvämare med den.
- Om fördröjningen innan locket stängs (efter att ditt husdjur ätit klart och gått iväg) inte passar husdjuret kan du försöka öka/minska tiden det tar för locket att stängas i Sure Petcare-appen.

Locket till foderautomaten stängs inte helt

- Detta kan ha orsakats av att matrester fastnat under locket eller i dess mekanism. För att se till att locket fortsätter att stängas helt är det viktigt att ta bort matrester från foderautomatens ytor - **se sida 245-246**.
- Se till att du inte är i ett träningsläge - **besök sida 243** för att lära dig mer om beteenden i träningsläge.

Portionsindikatorlampor är på men skålen är tom

Om några av indikatorlamporna är gröna när du öppnar foderautomaten, även om det inte finns mat kvar i skålarna, innebär det att du måste göra en nollställning. För att lösa detta ska du se till att alltid trycka på nollställningsknappen innan du ersätter ditt husdjurs mat - **se sida 241-242**.

Portionsindikatorlamporna svarar inte

- Var medveten om att om du inte har ställt in en portionsvikt i Sure Petcare-appen kommer portionsindikatorlamporna inte att lysa upp när du lägger till mat åt ditt husdjur.
- Skräp som fastnat på vågarmarna kan också påverka foderautomatens prestanda, så se till att detta område är rent - **se sida 245-246**.

Andra husdjur tar maten

- Om giriga husdjur försöker stjäla mat från en öppen foderautomat kan du minska tiden det tar för locket att stängas efter att husdjuret har ätit klart i Sure Petcare-appen.
- Det kan också finnas en anpassad inställning som hjälper till att lösa ditt specifika problem. Vänligen kontakta vårt kundtjänsteam för att diskutera din situation - **se bakskyddet för kontaktuppgifter**.
- Alternativt, om giriga husdjur lyckas stjäla mat från sidan eller den bakre sidan av foderautomaten (när locket är öppet och det behöriga husdjuret äter), så finns det ett baksideskydd som hjälper till att stoppa ett sådant listigt och beslutsamt beteende. Mer information finns på **surepetcare.com/accessories**.

Kort batteritid

- Se till att foderautomaten är ren och att sensorerna inte täcks av smuts - **se sida 245**.
- Se till att batterierna är av bra kvalitet och att de är korrekt isatta - **se sida 235**.
- Kontrollera att det inte finns några uppenbara källor till elektriskt brus i området (dvs. blinkande lampor etc.). Ring vårt kundtjänsteam om du misstänker att så är fallet. Se **bakskyddet** för mer information.

Flera foderautomater i samma hushåll

- Om du eller dina husdjur är förvirrade över vilken foderautomat som tillhör vem kan du prova att använda skålar i olika färger samt placera automaterna på olika ställen. Detta bör hjälpa. Olika färgade skålar och mattor säljs separat. Mer information finns på **surepetcare.com/accessories**.

Behöver du mer hjälp?



- Om du fortsätter ha problem med anslutningen kan du besöka: **surepetcare.com/hub-connectivity**
 - För guider, videor och kundforum kan du besöka: **surepetcare.com/support**
 - Om du har problem med Sure Petcare-appen kan du besöka: **surepetcare.com/apphelp**
- Eller så kan du kontakta vårt trevliga kundtjänsteam. **Vänligen se bakskyddet för information.**



Garanti och ansvarsfriskrivning

Garanti: SureFeeds foderautomat Connect med mikrochip har tre års garanti från och med inköpsdatumet mot uppvisande av kvitto. Garantin är begränsad till material-, komponent- och tillverkningsfel. Garantin omfattar inte produkter med fel som orsakas av normalt bruk och slitage, misskötsel, vanskötsel eller avsiktlig skada. Vid fel på grund av felaktiga delar eller felaktigt utförande kommer delen att ersättas utan kostnad endast under garantiperioden. Efter tillverkarens godtycke kan en ersättande produkt tillhandahållas utan kostnad vid svårare fel. Detta påverkar inte dina lagliga rättigheter.

Ansvarsfriskrivning: Foderautomaten Connect med mikrochip och appen rapporterar husdjurets konsumtion av mat genom att detektera husdjurets ID-mikrochip och sedan mäta skålens vikt före och efter att djuret ätit. I de flesta fall kommer detta att ge tillförlitliga uppgifter om matkonsumtionen, men oväntad eller ovanlig användning av foderautomaten (dvs. om ett husdjur tar bort skålen eller leker med maten) kan leda till opålitlig information. Sure Petcare tar inte ansvar för skador eller problem som kan uppstå till följd av felaktig rapportering av matkonsumtion.

SureFeeds foderautomat Connect med mikrochip använder selektiva åtkomstfunktioner som är utformade för att minimera risken för att husdjur stjäla varandras mat. Det är dock inte möjligt att fullständigt garantera att alla andra husdjur hålls ute under alla omständigheter. Sure Petcare åtar sig inte ansvar för skador eller besvär som uppstår i det sällsynta fallet ett obehörigt husdjur får tillgång till foderautomaten.



Kassering av produkter och förbrukade batterier: Den här ikonen indikerar produkter som lyder under följande lag:

Direktivet om avfall som utgörs av eller innehåller elektrisk och elektronisk utrustning 2012/19/EU (WEEE-direktivet) och batteridirektivet 2006/66/EG (som ändrat 2013/56/EU) kräver att hushåll kasserar EEE-produkter och förbrukade batterier som har nått slutet av sin livstid på ett miljövänligt sätt. För att minska miljöpåverkan ska dessa inte kastas som hushållsavfall och bör återvinnas på en lämplig återvinningsstation. Mer information om återvinning finns på: www.recycle-more.co.uk.

Se till att batterierna byts ut före utgångsdatumet som visas på batteriet eller förpackningen och att du gör dig av med dem på ett säkert och lämpligt sätt.

Vid batteriläckage ska du använda lämpliga skyddskläder för att skydda dig mot exponering för skadliga kemikalier innan du gör dig av med batterierna och rengör eventuellt spill. Undvik kontakt med huden vid rengöring av spill. Batterikemikalier ska inte placeras nära ögonen eller förtäras. Kontakta omedelbart en läkare om detta skulle inträffa.

Varumärken: Google Play och Google Play-logotypen är varumärken som tillhör Google Inc. Apple är ett varumärke som tillhör Apple Inc. och är registrerat i USA och andra länder. Apple är ett servicemärke som tillhör Apple Inc. och är registrerat i USA och andra länder. IOS är ett varumärke eller registrerat varumärke som tillhör Cisco i USA och andra länder och används under licens.



SURETM
PETCARE

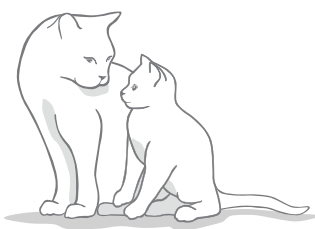

Bem-vindo ao seu novo Alimentador para animais de estimação com microchip Connect

Obrigado por escolher o Alimentador para animais de estimação com microchip Connect!

O sistema Alimentador para animais de estimação com microchip Connect é composto por três elementos, todos trabalhando juntos para manter você conectado ao seu animal de estimação e fornecer mais informações sobre seus hábitos alimentares.

O **Alimentador para animais de estimação com microchip Connect** é o principal componente do sistema. Ele reconhece o ID do microchip já implantado em seu animal de estimação ou a etiqueta para coleiras RFID Sure Petcare (uma incluída), permitindo que ele tenha acesso à comida enquanto mantém outros animais afastados.

O **hub** (vendido separadamente) é o elemento conectado do sistema. Ele se conecta à sua Internet doméstica e pode se comunicar com o alimentador e com o aplicativo Sure Petcare.

Ao usar o **aplicativo Sure Petcare**, você poderá monitorar a quantidade de comida que o animal consumiu e com que frequência ele visita o alimentador. O aplicativo também permite que você envie o peso de uma porção ao alimentador para poder controlar a quantidade de comida por porção.

Conteúdo da caixa

Verifique se você tem todas essas peças*

- 1 Alimentador para animais de estimação com microchip Connect
- 2 1 tigela simples
- 3 2 meias tigelas
- 4 1 esteira
- 5 1 suporte para a tigela simples
- 6 2 suportes para meia tigela
- 7 1 etiqueta para coleiras RFID Sure Petcare

*As pilhas e o hub não estão incluídos

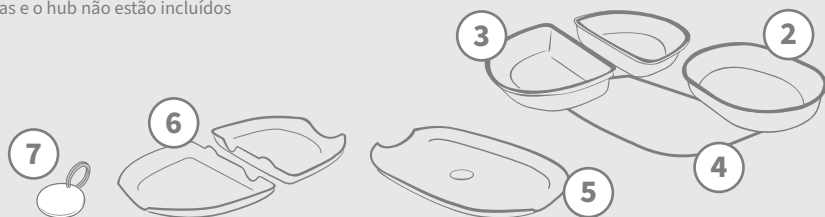
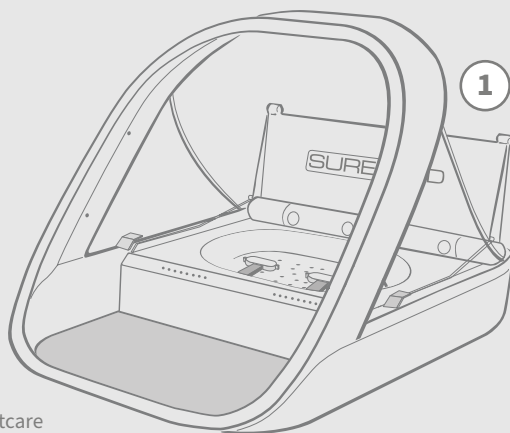

Para que o Alimentador para animais de estimação com microchip Connect funcione como um sistema conectado, você precisará adquirir um hub que o acompanha. Para obter mais informações sobre como comprar um hub, visite surepetcare.com/hub.

Conteúdo

Informações importantes	256
Visão geral do produto	258
Sistema Alimentador para animais de estimação com microchip Connect	260
Hub	
Configuração do hub	261
Onde colocar o hub	262
Luzes do hub	263
Alimentador	
Pilhas	264
Conectar o alimentador	265
Botões e luzes.....	266
Adicionar o animal de estimação ao alimentador.....	268
Definir as porções.....	269
Colocar e substituir o alimento	270
Modo de treinamento	272
Limpeza e manutenção	274
Ajuda e suporte	276
Garantia e isenção de responsabilidade	280



Informações importantes



LEIA ATENTAMENTE AS SEGUINTE INFORMAÇÕES E CONSERVE ESTE MANUAL PARA FUTURA REFERÊNCIA.



Este produto destina-se **apenas a animais domésticos.**



Use apenas acessórios SureFeed para garantir a compatibilidade: surepetcare.com/accessories



Comprove se estão todas as peças listadas nesta **página 253.**



Não coloque o alimentador em áreas por onde as pessoas passam frequentemente.



O alimentador foi projetado **apenas para uso em interiores.**



Não submerja o alimentador em água nem coloque-o debaixo de torneiras com água corrente.



Não coloque o alimentador na geladeira nem coloque bolsas de gelo debaixo ou dentro dele.



Não coloque o alimentador em lugares que possam ficar expostos a calor excessivo.



Este produto requer **4 pilhas tipo botão C** que devem ser inseridas e substituídas com cuidado. Não misture tipos de pilhas diferentes nem use uma combinação de pilhas novas e usadas. Se o alimentador for armazenado sem uso por um longo período, remova as pilhas.

O **código do produto** e o **número de série** se encontram na parte inferior do Alimentador para animais de estimação com microchip Connect.

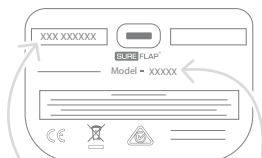

Número de série

Código do produto

Avisos de segurança

- **Não** use este produto se estiver faltando peças ou se houver peças danificadas ou gastas.
- **Este item contém pequenos componentes.** Quaisquer peças soltas devem ser mantidas fora do alcance de crianças e animais de estimação para **evitar riscos de asfixia.**

Outros pontos importantes a considerar



ANIMAIS DE ESTIMAÇÃO: A Sure Petcare recomenda que o Alimentador para animais de estimação com microchip Connect da SureFeed seja usado com o microchip implantado, mas também pode ser operado com a etiqueta para coleiras RFID Sure Petcare. Se estiver usando a etiqueta para coleira, ela deve ser usada com um colar de segurança que **incorpore uma fivela de segurança** (somente gatos). A Sure Petcare não se responsabiliza por qualquer lesão ou morte causada pela coleira de um animal de estimação.



ACESSO AO ALIMENTO: A Sure Petcare não se responsabiliza por nenhum tipo de acesso obtido por um animal não autorizado devido a uso não intencional. Como proprietário deste produto, **você assume total responsabilidade pela supervisão da administração de qualquer alimento** que possa causar danos a outros animais de estimação se consumido acidentalmente.



SEM FUNÇÃO DE TEMPORIZADOR: Este produto não contém um temporizador e **não oferece nenhuma funcionalidade relacionada ao controle do tempo**. Portanto, não deixe seu animal de estimação sem vigilância nem confie neste produto para alimentá-lo por períodos prolongados — não mais que 24 horas para um gato ou o intervalo médio de tempo entre as refeições no caso de cachorros pequenos. **Este produto não substitui o proprietário em sua responsabilidade pelo animal de estimação.**



CRIANÇAS: As crianças **não devem ter permissão para brincar com o Alimentador para animais de estimação com microchip Connect SureFeed**. Não é um brinquedo e não deve ser tratado como tal. No entanto, este produto pode ser usado por crianças a partir dos 8 anos de idade e também por pessoas com capacidades físicas, sensoriais ou mentais reduzidas, desde que supervisionadas ou tenham recebido instruções sobre como usar o produto de maneira segura. Eles devem sempre estar cientes de quaisquer possíveis riscos implicados. Não permita que crianças de qualquer idade limpem o produto sem supervisão.



PROTEÇÃO CONTRA CRIANÇAS: Em famílias com crianças, é essencial **incluir o Alimentador para animais de estimação com microchip Connect SureFeed na lista de itens que as crianças não devem tocar sem supervisão de um adulto**. O uso incorreto deste produto por uma criança pode fazer com ela corra possíveis perigos. Por esse motivo, as crianças pequenas devem ser monitoradas o tempo todo quando estiverem próximas do alimentador. Lembre-se também de que, quando o alimentador estiver **no modo de treinamento (consulte as páginas 271-272), uma criança ainda poderá ter acesso à comida do animal**.



Visão geral do produto

O sistema Alimentador para animais de estimação com microchip Connect consiste em três partes:



Alimentador para animais de estimação com microchip Connect

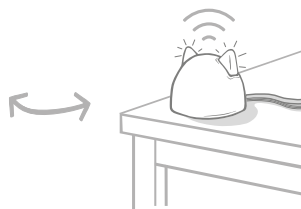

Hub

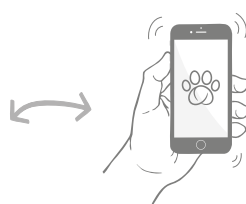

Aplicativo Sure Petcare

O hub se conecta à Internet por um cabo Ethernet e monitora a atividade do seu Alimentador para animais de estimação com microchip Connect. Ele se comunica com o alimentador e com o aplicativo Sure Petcare, permitindo que você veja as atualizações no aplicativo Sure Petcare, mesmo quando estiver longe de casa!

Você também pode definir o peso da porção no aplicativo. Depois de definida, o alimentador orientará você à medida que o alimento é adicionado para garantir que o animal receba a porção correta. Para obter mais informações, **consulte a página 266.**

Sensores: quatro pequenos pontos no interior do arco são usados para detectar o animal de estimação.

Suportes para tigelas: consulte a página 258.

Trava da tampa: consulte a página 265.

Esteira: desenhada para coletar sujeira, facilitando a limpeza do alimentador.

LED traseiro: consulte a página 266.

Botões: consulte a página 265.

Luzes indicadoras da porção: consulte a página 266.

Compartimentos das pilhas: consulte a página 263.

Tampa de acesso para limpeza: consulte a página 273.

Luzes do hub: consulte a página 262.

Porta Ethernet: para conexão com o roteador de Internet.

Fonte de alimentação: para conectar o cabo da fonte de alimentação.

As tigelas SureFeed têm uma vedação integrada na borda superior, ajudando a conservar a comida do seu animal de estimação fresca por mais tempo. Se você alimentar seu animal de estimação apenas com um tipo de alimento, poderá usar a tigela única, mas se der a ele alimentos úmidos e secos, as meias tigelas serão perfeitas!



Tigela simples - pode conter 250 g, suficiente para pelo menos 2 bolsas de ração úmida.

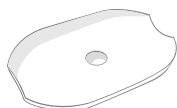

Suporte para tigela simples - foi projetado para conter a tigela simples (e não as meias tigelas).

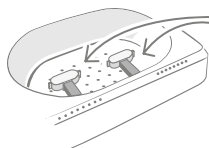

Braços de pesagem - projetados para conter o suporte da tigela.



Meias tigelas - cada tigela pode conter até 100 g, ou 200 g em total nas duas tigelas.



Suporte para meia tigela - foi projetado para conter uma meia tigela (e não a tigela simples).

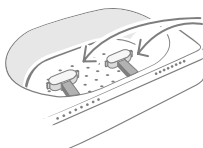

Braços de pesagem - projetados para conter os suportes das meias tigelas.

Não coloque a comida do animal diretamente em cima dos suportes da tigela.

Sempre use as tigelas para garantir o correto funcionamento do alimentador.



A tigela com divisão SureFeed não se destina ao uso com o Alimentador para animais de estimação com microchip Connect.

Para comprar tigelas ou esteiras adicionais, pergunte a um revendedor Sure Petcare ou acesse surepetcare.com.

Deixe o ambiente mais colorido



As tigelas e esteiras de plástico SureFeed vêm em quatro cores: azul, verde, rosa e cinza.

Ou com um pouco mais de brilho

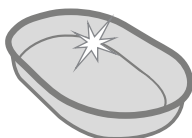

A tigela simples SureFeed também pode ser adquirida em aço inoxidável.



Não coloque as tigelas na máquina de lavar louça nem no micro-ondas.



Lave as tigelas à mão antes do primeiro uso.



Sistema Alimentador para animais de estimação com microchip Connect

Baixe o aplicativo Sure Petcare gratuito agora

BAIXAR NA
APP STORE

DISPONÍVEL NO
GOOGLE PLAY



surepetcare.io



Receba notificações quando seu animal de estimação comer no alimentador.



Monitore o alimento ingerido pelo seu animal de estimação e observe mudanças no comportamento.



Sirva o alimento com precisão para controlar a quantidade consumida por porção.



Compartilhe o acesso à sua casa com familiares e amigos.



Baixe o **aplicativo Sure Petcare** e crie uma conta. Você será solicitado a criar uma "casa", isto é, uma rede conectada que contém todos os seus produtos e animais de estimação conectados ao Sure Petcare. Você pode convidar outros membros de sua família para entrar em sua casa.

Para baixar o aplicativo, seu telefone ou tablet deve ter no mínimo o **iOS 9** na **Apple** ou **4.4** no **Android**.



Se preferir controlar os produtos conectados ao Sure Petcare no seu computador, você pode usar o aplicativo da Web Sure Petcare em **surepetcare.io**.

Será necessário ter a versão mais recente do **Safari**, **Chrome**, **Firefox** ou **Internet Explorer** em execução no **Mac OS X v10.9** (ou acima) ou no **Windows 7** (ou acima).

Comprar um hub da Sure Petcare



Para que o Alimentador com microchip para animais de estimação Connect funcione com o aplicativo Sure Petcare, você precisará adquirir um hub que o acompanha. Para obter mais informações, consulte surepetcare.com/hub.



Configuração do hub

Depois de baixar com sucesso o aplicativo Sure Petcare, você precisará conectar o hub e configurá-lo. Depois que o hub estiver configurado, você será solicitado a conectá-lo ao alimentador e ao aplicativo. Siga as etapas abaixo:

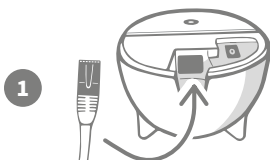

Conecte uma extremidade do cabo Ethernet à base do hub e a outra extremidade a uma porta Ethernet sobressalente do roteador.

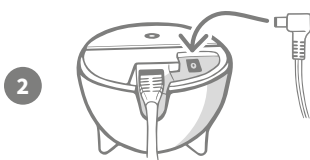

Monte a fonte de alimentação e conecte-a à tomada. Conecte a outra extremidade do cabo à base do hub.

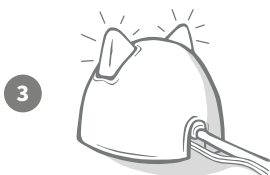

As "orelhas" do hub começarão a ficar **vermelhas e verdes de forma alternada**. Quando as duas orelhas ficarem verdes, o hub está pronto. Se as orelhas não fizerem essa sequência, **consulte a página 262** para obter mais informações.



Para concluir a instalação do sistema Alimentador para animais de estimação com microchip Connect, você precisará **seguir as etapas restantes no aplicativo Sure Petcare**.



O hub pode receber atualizações de software. Caso você veja **luzes vermelhas sólidas** durante a instalação, não entre em pânico, o software do seu hub está sendo atualizado. Depois de concluído, o hub será reiniciado e você verá a sequência de luzes detalhada na etapa 3.



Onde colocar o hub

Como o sistema Alimentador para animais de estimação com microchip Connect se comunica através de conexão sem fio, o local do hub pode afetar seu desempenho.



Coloque o hub a pelo menos 1 metro do chão (ou seja, em uma mesa o mais livre possível de obstáculos).

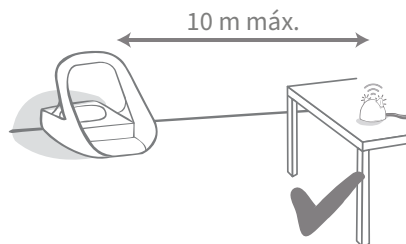

Tente colocar o hub de forma que fique alinhado com o alimentador e dentro de um raio de 10 metros.

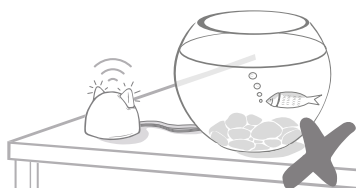

Evite colocar o hub próximo ou no campo de visão de grandes quantidades de água (por exemplo, aquários).

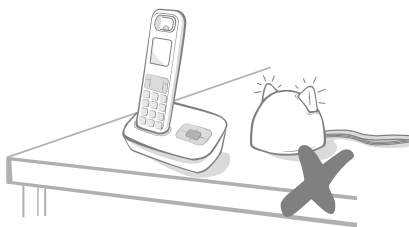

Mantenha o hub o mais longe possível de possíveis fontes de interferência (por exemplo, telefones sem fio digitais, monitores de bebê, etc.).



Verifique se o hub não está próximo a objetos grandes de metal (por exemplo, geladeiras).

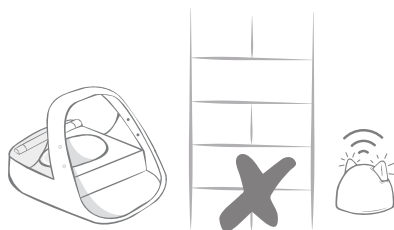

Evite paredes maciças entre o hub e o alimentador.



Esporadicamente, o hub pode ter problemas de conexão, apesar de você seguir estas dicas. Para obter mais conselhos sobre como colocar o hub mais próximo do Alimentador para animais de estimação com microchip Connect, acesse surepetcare.com/hub-connectivity.



Se o hub perder a conexão com a Internet por qualquer motivo, o Alimentador para animais de estimação com microchip Connect continuará funcionando normalmente e manterá suas configurações.



Luzes do hub

O hub indica seu estado atual através das luzes das orelhas. Sequências de luzes coloridas diferentes têm significados diferentes.

Luzes de configuração

Sempre que o hub for ligado ou tentar se conectar a outros elementos do sistema, você verá as luzes de configuração:

- 1** as orelhas **alternarão em vermelho** durante um tempo,

- 2** depois **alternarão em verde**,

- 3** depois de um **flash laranja** e de as orelhas ficarem **verdes**, o hub estará conectado.



Orelhas verdes

Orelhas verdes significam que o hub está funcionando corretamente. Consulte abaixo os detalhes do significado de cada sequência de luzes.

As duas orelhas estão verdes – O hub está ligado, conectado e funcionando corretamente.

Orelhas alternando em verde – O hub está se reconectando aos nossos servidores.

Orelhas vermelhas

As duas orelhas estão vermelhas – O hub está atualizando o software. Seja paciente, o hub será reiniciado e continuará normalmente em breve.

As duas orelhas estão piscando em vermelho – O hub perdeu a conexão com o alimentador e está tentando se reconectar.

Orelhas alternando em vermelho – O hub está com dificuldades para se conectar à Internet e/ou aos servidores.

- i** Para obter mais informações sobre o diagnóstico desses problemas, **consulte a página 276**.



Pilhas

Use sempre **4 pilhas tipo botão C alcalinas de 1,5 V de boa qualidade**. Isso garantirá o melhor desempenho do seu Alimentador para animais de estimação com microchip Connect. **Este produto NÃO foi projetado para uso com pilhas recarregáveis.** Para inserir ou trocar as pilhas, siga as etapas abaixo:

i Há uma luz perto da parte traseira do alimentador. Se as pilhas estiverem fracas ou se houver algum problema com a forma como foram inseridas, essa luz piscará em vermelho a cada 5 segundos.

1

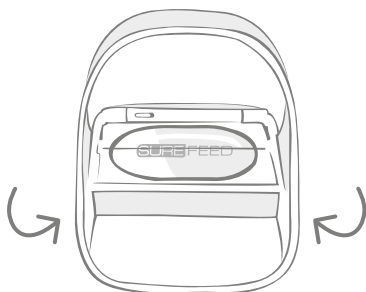

Vire o alimentador de cabeça para baixo para acessar os compartimentos das pilhas.

2

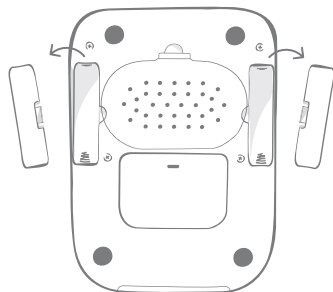

Retire as tampas dos compartimentos das pilhas.

3

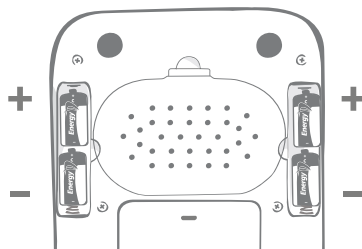

Coloque as pilhas. Verifique se os símbolos +/- das pilhas correspondem aos símbolos no alimentador.

4

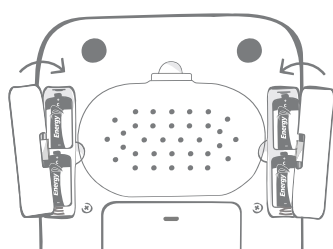

Coloque as tampas dos compartimentos das pilhas.



Depois de programar o ID do microchip do seu animal de estimação no alimentador, ele será armazenado permanentemente em sua memória. Isso significa que, mesmo quando você troca as pilhas, o alimentador ainda reconhece o animal de estimação autorizado.



Conectar o alimentador

Para concluir a configuração do sistema conectado, você precisa conectar o alimentador à sua casa.

1

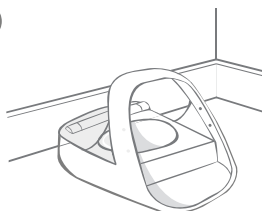

Coloque o alimentador no local pretendido. Faça isso para garantir que ele possa se comunicar com o hub.

2



No aplicativo Sure Petcare, selecione **"Adicionar produto"**.

3



O hub entrará no modo de conexão e as orelhas piscarão em verde.

4

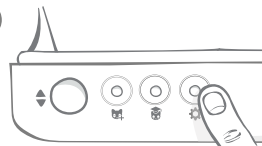

Pressione uma vez o botão de configurações "⚙️" no alimentador. O LED da orelha acenderá em verde.

5

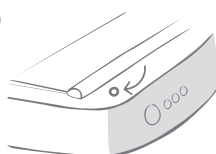

Quando o alimentador estiver conectado, o LED se apagará e o hub deixará de piscar.

i

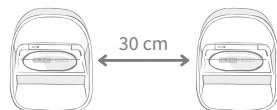

Se quiser conectar mais alimentadores, poderá fazer isso facilmente no aplicativo.

Adicionar um alimentador à casa atual



Você pode adicionar um Alimentador para animais de estimação com microchip Connect à sua casa Sure Petcare existente através do aplicativo. Vá para a seção Casa e siga as instruções acima.

Você também pode atribuir o ID do microchip do seu animal de estimação remotamente no aplicativo. Isso significa que você não precisará adicioná-lo manualmente.

No entanto, adicionar animais de estimação usando guloseimas pode incentivá-los a usar o novo produto. **Consulte a página 267** para obter mais informações sobre a adição de animais de estimação.



Botões e luzes

Botões

Existem 5 botões no alimentador. Eles se encontram na parte traseira do produto:

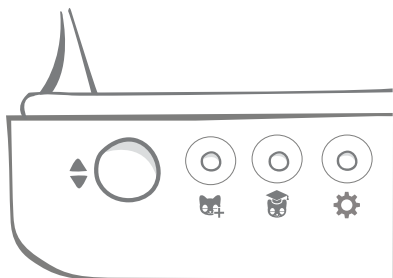

Botão Abrir/Fechar - abre e fecha a tampa para que você possa ter acesso à(s) tigela(s).



Botão Adicionar animal de estimação - usado para adicionar o ID do microchip do seu animal de estimação ao alimentador. **Consulte a página 267.**



Botão Modo de treinamento - usado para ativar o modo de treinamento que ensina seu animal de estimação a usar o alimentador. **Consulte as páginas 271-272.**



Botão Configurações - usado para conectar o alimentador ao hub. **Consulte a página 264.**



Botão Zerar - usado para calibrar o alimentador e garantir a quantidade correta de alimento. **Consulte a página 269.** Esse botão irá zerar **os dois lados do alimentador, esteja você usando uma tigela simples ou duas meias tigelas.**



Ao usar **meias tigelas**, se você quiser zerá-las separadamente, poderá fazer isso usando o **aplicativo Sure Petcare.**

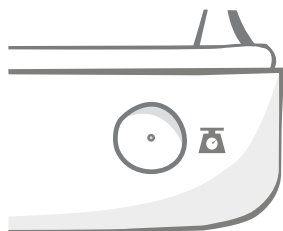

Trava da tampa



Bloqueada - isso significa que a tampa não pode ser deslizada nem removida do alimentador.



Desbloqueada - você pode deslizar a tampa quando estiver na posição aberta para removê-la.

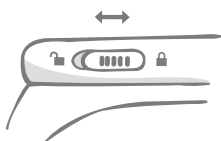

A trava da tampa deve permanecer **bloqueada** o tempo todo e dever ser desbloqueada somente quando você quiser remover a tampa para limpeza. Isso permite que os inteligentes animais de estimação não autorizados tentem remover a tampa para ter acesso aos alimentos. **Esteja ciente de que isso não impede que a tampa se abra.**

LED traseiro

Luz verde sólida. A luz verde acenderá toda vez que um animal autorizado comer no alimentador.

Luz verde piscando. O alimentador está no modo "Adicionar animal de estimação". **Consulte a página 267.**

A luz continuará piscando até que um microchip seja adicionado ou até você sair do modo.

Luz laranja piscando. O alimentador está no modo de treinamento. **Consulte a página 271-272.** O número de piscadas está relacionado ao estágio do treinamento.

Luz vermelha piscando. As pilhas estão acabando.

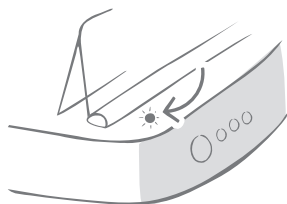

Luzes indicadoras da porção

Se tiver definido o peso da porção no aplicativo Sure Petcare, as luzes da frente do alimentador servirão de guia ao colocar o alimento.

As luzes indicadoras de porção representam a quantidade de comida que você colocou para garantir que seu animal de estimação esteja recebendo a porção correta.

Para obter mais informações sobre os benefícios de definir porções fixas, **consulte a página 268.**

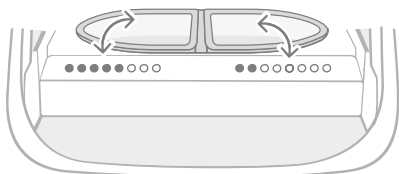
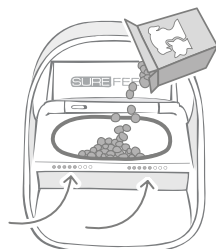

Como usar as meias tigelas

As luzes do lado direito do alimentador correspondem à tigela da direita e as luzes do lado esquerdo, à tigela da esquerda. As luzes acenderão quando o alimento for colocado em cada lado.

Como usar a tigela simples

Ambos os conjuntos de luzes acenderão simultaneamente quando o alimento for colocado na tigela simples.

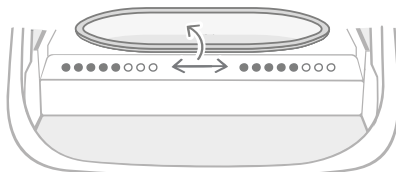

Se você quiser alternar das meias tigelas para a tigela simples e vice-versa, faça a alteração usando o aplicativo Sure Petcare.



Se não tiver definido o peso da porção no aplicativo, as luzes não irão acender quando o alimento for colocado no alimentador.



Adicionar o animal de estimação ao alimentador

Ao adicionar o ID do microchip do animal de estimação no Alimentador para animais de estimação com microchip Connect, certifique-se de que todos os outros animais de estimação e todas as etiquetas para coleiras não necessárias sejam afastados do alimentador.

1

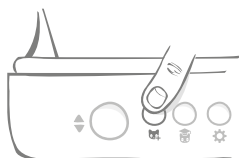

Pressione o botão "Adicionar animal de estimação" (🐱), na parte traseira do alimentador.

2

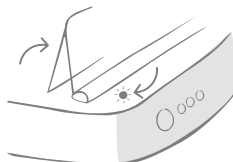

A tampa se abrirá e o LED traseiro piscará em verde uma vez por segundo.

3

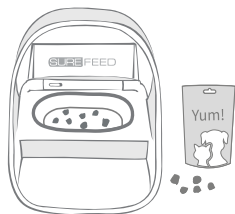

Coloque alimento ou algumas guloseimas na tigela e coloque o alimentador onde você normalmente alimentaria seu animal de estimação.

4



Enquanto o animal de estimação come, o alimentador verifica o ID do microchip dele. Depois de adicionar o ID, **o LED para de piscar** (mas permanece aceso).

5

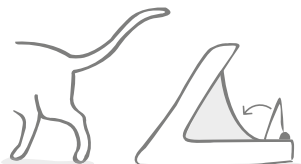

Quando o animal se afasta, a tampa se fecha e o LED verde se apaga. O ID do microchip agora está armazenado permanentemente.

i



Se necessário, é possível cancelar o modo "Adicionar animal de estimação" a qualquer momento com um segundo toque no botão "Adicionar animal de estimação" (🐱).



Para programar o ID do microchip de um animal de estimação, os sensores localizados no arco do alimentador devem detectar a presença do animal. Portanto, é importante garantir que o animal de estimação passe a cabeça pelo arco para comer.



Para programar uma etiqueta para coleiras RFID Sure Petcare, basta seguir as etapas acima, mas segure a etiqueta dentro do arco. Certifique-se de não usar joias de metal ao programar uma etiqueta para coleiras.



Se já tiver um animal de estimação registrado na sua casa Sure Petcare, é possível atribuí-lo ao alimentador. No aplicativo, vá para a seção Casa. Se você adicionar o animal de estimação errado por engano, poderá corrigi-lo aqui.



Definir as porções

O Alimentador para animais de estimação com microchip Connect não apenas monitora quando e o que seu animal está comendo, mas também pode ajudá-lo a estipular porções fixas sempre que você alimentar o animal.

Por que você deve definir as porções de comida do seu animal de estimação?

Seu animal de estimação poderia se beneficiar com a perda de alguns quilos? Ao definir o peso das porções, você pode garantir que não está acidentalmente oferecendo muita comida todos os dias. Tudo ajuda!

A capacidade de pesar as porções de comida diretamente no alimentador agiliza, facilita e é uma forma mais cômoda de garantir que seu animal de estimação esteja comendo a quantidade correta.

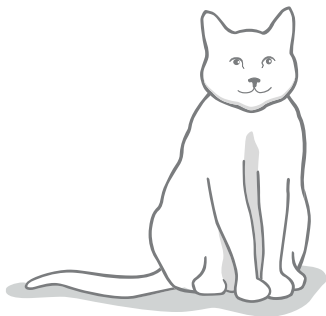

Quanto você deve alimentar seu animal de estimação?

Pode ser difícil saber qual é a quantidade certa para o seu animal de estimação, especialmente quando há muitas opções. Recomendamos consultar seu veterinário ou consultor de saúde animal para ver o que eles recomendam.

Como alternativa, siga as orientações fornecidas na embalagem do fabricante de alimento para animais. Estas informações são normalmente um bom guia para animais de estimação saudáveis dentro do normal.

Como definir o peso da porção no aplicativo

É possível definir o peso da porção no aplicativo Sure Petcare. Uma vez definido, esse valor é enviado ao alimentador para que ele saiba quanta comida você deseja dar ao seu animal de estimação por porção.

As luzes indicadoras de porção no alimentador orientarão você à medida que o alimento for sendo colocado a fim de garantir que a quantidade colocada seja a correta. As luzes representam a quantidade de comida colocada.

Consulte a página 270 para obter mais informações.





Colocar e substituir o alimento

É importante trocar a comida do animal diariamente, não apenas para garantir que ele fique feliz e saudável, mas também para manter o alimentador limpo e em boas condições de funcionamento.



1
Pressione o botão
Abrir/Fechar (◊).

6
Quando todas as luzes estiverem piscando em verde, isso indica que as tigelas estão com a porção completa.

2
Remova as tigelas sujas e quaisquer resíduos. Limpe-as ou substitua-as por outras tigelas limpas.

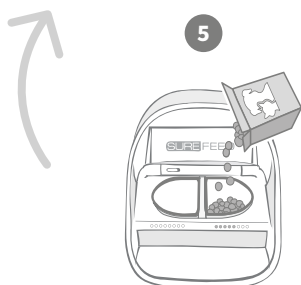

5
Após a sequência de luzes que ocorre ao zerar, comece a encher as tigelas. As luzes indicadoras da porção acenderão para mostrar a quantidade de comida em cada tigela. Consulte a próxima página.

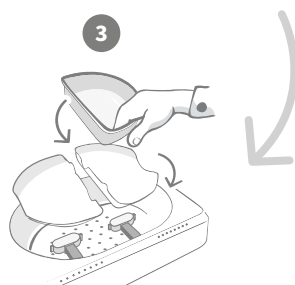

3
Certifique-se de que os suportes apropriados para uma ou meia tigela estejam corretamente apoiados nos braços de pesagem e **coloque uma tigela vazia em cima.**

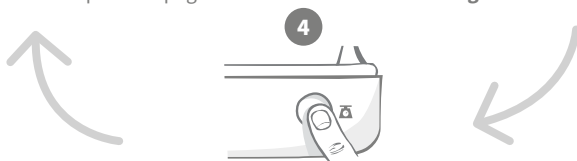

4
Pressione o botão Zerar antes de encher as tigelas para garantir que uma porção completa esteja sendo dada ao seu animal de estimação. Lembre-se de que pressionar esse botão zerará **os dois lados do alimentador. Consulte a página 265.**

Luzes indicadoras da porção



Zerar a sequência de luzes:

Luzes verdes descendentes da direita para a esquerda aparecem quando você pressiona o botão Zerar.



Colocar comida:

À medida que o alimento é colocado, as luzes indicadoras de porção vão acendendo em verde, da esquerda para a direita. As luzes correspondem à quantidade de comida na tigela. Você precisa continuar colocando a comida até que todas as luzes pisquem.



Atingir o peso da porção:

Quando faltar +/- 1 g para completar o peso da porção, as luzes **pisarão em verde**. Se as luzes não estiverem piscando, a porção completa ainda não foi atingida.



Excesso de alimento:

Se você colocar na tigela mais alimento do que o peso definido para a porção, as **luzes vermelhas** avisarão que há excesso de comida. Simplesmente remova um pouco de alimento até que as luzes pisquem em verde.



Saiba que, se você não tiver definido o peso da porção no aplicativo, as luzes **não irão acender** quando o alimento for colocado no alimentador.

Ainda sobrou comida na tigela?

Se ainda houver comida na tigela na hora do jantar, não é necessário pressionar o botão zero, basta acrescentar mais comida ao alimentador e ele permitirá colocar uma nova porção sobre a comida restante na tigela. A luz indicadora da porção permitirá que a quantidade de uma porção inteira seja colocada e indicada pelas luzes.

1

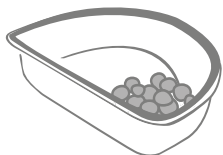

Ao abrir a tampa, algumas luzes piscam momentaneamente para indicar que o alimentador sabe que ainda há comida na tigela. A seguir, todas as luzes se apagam para permitir que você coloque uma nova porção fresca sobre o alimento restante.

2

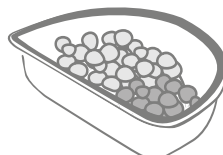

Encha a tigela até que todas as luzes indicadoras de porção estejam piscando em verde.



Modo de treinamento

(como ensinar seu animal de estimação a usar o alimentador)



Quando aberto através do botão Abrir/Fechar, a luz laranja de treinamento pisca em vermelho para ajudar a identificar que o botão Abrir/Fechar foi pressionado e está no modo aberto.

A luz de treinamento voltará para a cor laranja quando o botão Abrir/Fechar for pressionado depois de colocar a porção de comida. **Se o botão Abrir/Fechar não for pressionado, as luzes indicadoras de porção não serão ativadas e o sistema não poderá identificar a adição de alimentos.**

PARTE 1 - Apresentar o alimentador ao animal de estimação

Alguns animais de estimação podem precisar de algum tempo para se acostumar com o alimentador. O modo de treinamento permite introduzir cada vez mais movimentos à tampa, o que significa que o animal de estimação pode ganhar confiança usando sua nova tigela. Isso pode demorar um pouco, mas seja paciente e não passe para a **PARTE 2** até que seu animal de estimação pareça tranqüilo.

1

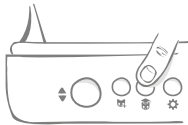

Com a tampa fechada, pressione o botão "Modo de treinamento" (🔴) uma vez na parte traseira do alimentador. A tampa se abrirá e o LED traseiro piscará em laranja (uma vez a cada poucos segundos).

2

Encha a tigela com a comida favorita do seu animal de estimação e coloque a unidade no local de alimentação normal do animal ou em algum lugar que ele se sinta confortável.

3



Durante esta primeira etapa do treinamento do animal de estimação no uso do alimentador, **a tampa não fechará** depois que eles terminarem de comer.



Lembre-se de não se precipitar e deixe seu animal de estimação se acostumar com a nova tigela. Quando ele estiver acostumado, passe para a PARTE 2.

PARTE 2 - Aumentar o movimento da tampa

Aumentar lentamente o movimento da tampa permite que o animal se acostume em três etapas. Mais uma vez, para obter os melhores resultados e um animal de estimação feliz, é importante ter paciência e não acelerar esse processo. O tempo necessário em cada estágio varia para cada animal de estimação (dias/semanas), mas recomendamos alguns dias para cada animal.

4

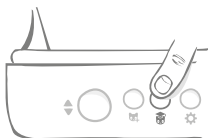

Comece a aumentar o movimento da tampa pressionando o botão "Modo de treinamento" (🔴) mais uma vez. A tampa fechará um pouco e o LED traseiro piscará em laranja duas vezes.

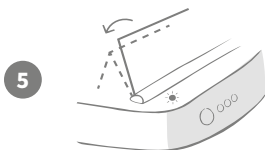

5

Agora, quando o animal de estimação comer na tigela, haverá um pouco de movimento quando a tampa se abrir completamente. Quando ele terminar de comer, a tampa fechará um pouco.



6

Permita que o animal de estimação se acostume com o novo movimento da tampa. Quando a comida precisar ser trocada, faça isso normalmente. **Consulte a página 269.** Depois de substituir o alimento, pressione o botão Abrir/Fechar (↕) para fechar a tampa na posição de treinamento.



Lembre-se de não se precipitar. Não passe para a próxima etapa até que o animal de estimação esteja confiante com essa quantidade de movimento da tampa.

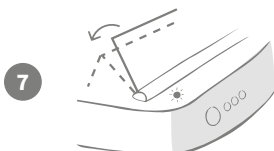

7

Quando o animal de estimação estiver acostumado com o movimento, pressione o botão "Modo de treinamento" (🐾) novamente. A tampa fechará um pouco mais, até a próxima posição, e o LED traseiro piscará em laranja três vezes.



Novamente, continue usando o alimentador normalmente e não passe para a próxima etapa até que o animal de estimação esteja acostumado com esse movimento.

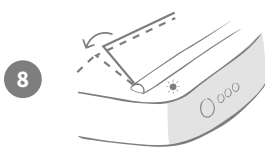

8

Agora, seu animal de estimação já deveria estar acostumado com o movimento da tampa para passar para o estágio final do treinamento e fechar a tampa ainda mais. Como antes, pressione o botão "Modo de treinamento" (🐾) novamente. A tampa fechará até a posição final e o LED traseiro piscará em laranja quatro vezes.



9

Quando o animal de estimação estiver acostumado com esta posição final, pressione (🐾) novamente. A tampa se fechará completamente e o LED traseiro não piscará mais. O alimentador está agora tampado e no modo de uso diário.



Você pode finalizar o modo de treinamento a qualquer momento mantendo pressionado o botão "Modo de treinamento" (🐾) por **5 segundos**.



Se precisar retroceder uma etapa, siga a dica acima. Isso retira o alimentador do modo de treinamento e o processo pode ser reiniciado.



Se seu animal de estimação parecer nervoso após a tampa se fechar, no aplicativo Sure Petcare, você poderá ajustar o período de tempo para que a tampa se feche.



Limpeza e manutenção

É importante manter o Alimentador para animais de estimação com microchip Connect limpo a fim de garantir que funcione de maneira confiável. **NÃO submerja a unidade inteira em água nem a coloque debaixo de torneiras com água corrente! A água pode causar danos ao alimentador e seus componentes eletrônicos.**

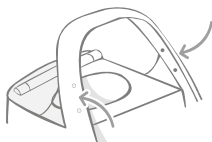
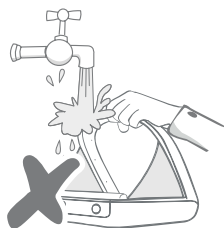

Certifique-se de que os quatro pontos pretos no arco estejam sempre limpos. A esteira pode ser limpa com um pano úmido. **Não coloque os itens na máquina de lavar louça. Lavar somente à mão.**

O Alimentador para animais de estimação com microchip Connect inclui uma **tampa de acesso para limpeza** em sua base para facilitar a remoção de migalhas ou restos.

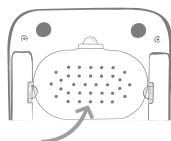

Como remover a tampa para limpeza

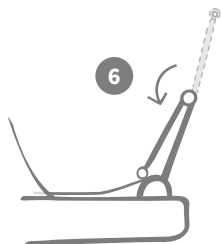

Agora vire a metade superior da tampa para que fique apoiada nas guias da tampa.

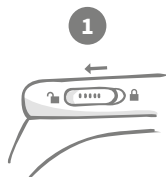

Mova o controle deslizante da trava da tampa para a posição desbloqueada.

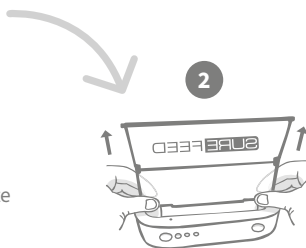

Pressione o botão (◊). Quando a tampa estiver aberta, puxe-a para cima.

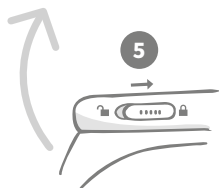

Mova o controle deslizante da trava da tampa de volta para a posição bloqueada.

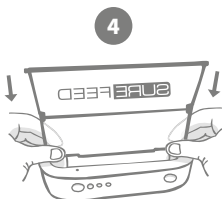

Após a limpeza, recoloca a tampa mantendo as duas metades na vertical. Verifique se está bem encaixada.

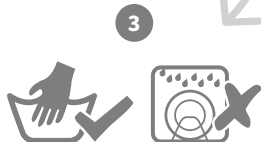

Lavar somente à mão. **Não** coloque na máquina de lavar louça.

Como garantir que o alimentador seja mantido limpo

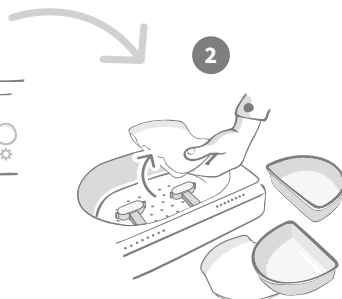

Remova as tigelas, os suportes da tigela e a tampa. Consulte a página anterior.

Recoloque todas as peças, certificando-se de **colocar a tampa de acesso para limpeza primeiro**.

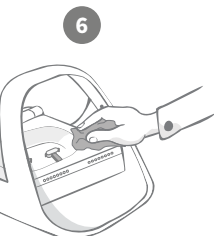

Use um pano úmido para garantir que todas as superfícies do alimentador estejam limpas. **Não use produtos de limpeza abrasivos.**

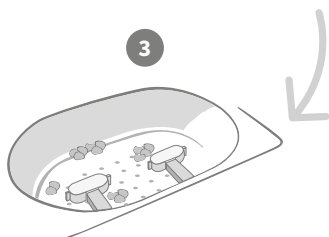

Os resíduos presos nos braços de pesagem podem afetar o desempenho do alimentador, por isso é muito importante mantê-los limpos. **Não use esponjas abrasivas**, pois elas podem danificar o alimentador e fazer com que ele não funcione corretamente.

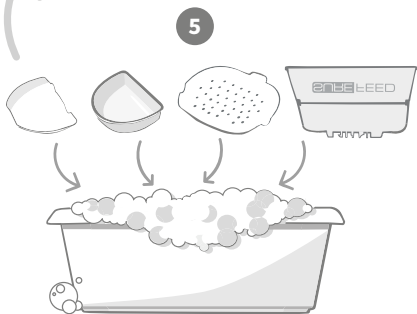

Lave à mão todas as peças removíveis. Não as coloque na máquina de lavar louça.

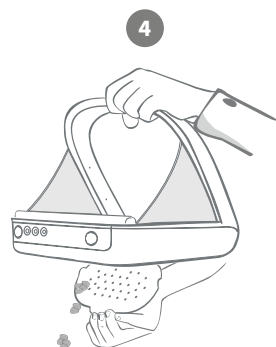

Segure o alimentador sobre o lixo, remova a tampa de acesso para limpeza e deixe os resíduos caírem.



Ajuda e suporte

Configurações personalizadas

Entendemos que nem todos os animais de estimação se comportam da mesma maneira, por isso projetamos o Alimentador para animais de estimação com microchip Connect para se adaptar a isso. O alimentador contém várias configurações personalizadas projetadas para ajudar caso seus animais de estimação usem o alimentador de maneira inesperada ou anormal. Abaixo estão apenas alguns exemplos de comportamento animal que as configurações personalizadas podem solucionar:

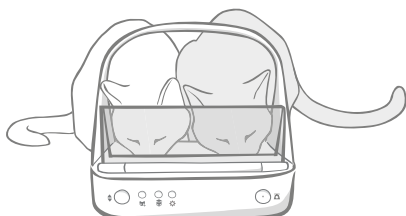

Seu animal de estimação não autorizado abre caminho para comer ao mesmo tempo que seu animal de estimação autorizado?

Temos uma configuração personalizada para isso!

Seu animal de estimação não autorizado gosta de roubar comida do alimentador de outro animal de estimação enquanto o alimentador está no modo de treinamento?

Temos uma configuração personalizada para isso!

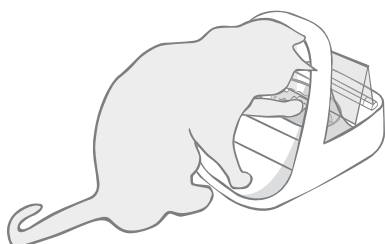

Seu esperto animal de estimação não autorizado descobriu como impedir a tampa de fechar?

Temos uma configuração personalizada para isso!

O animal de estimação não autorizado tenta roubar comida da parte traseira do alimentador?

Temos um acessório para isso!

Acesse surepetcare.com/accessories e procure por tampa traseira.

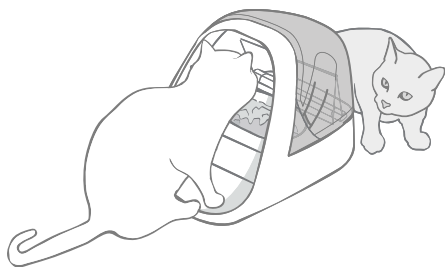

Entre em contato com nossa equipe de atendimento ao cliente para falar sobre as configurações personalizadas. **Consulte a contracapa para obter detalhes.** Eles poderão recomendar a configuração personalizada mais apropriada para sua situação e configurá-la para você remotamente.

O hub

Orelhas piscando em vermelho

Seu hub perdeu a conexão com o Alimentador para animais de estimação com microchip Connect.

- Se as **duas orelhas piscarem em vermelho durante a instalação**, execute uma redefinição de fábrica pressionando o botão na base do hub por 10 segundos.
- Se as **duas orelhas piscarem em vermelho por períodos prolongados após a instalação**, tente ligar e desligar o hub. Desligue-o da tomada por 30 segundos e ligue-o novamente. Se as orelhas ficarem em verde sólido por alguns minutos, o hub se reconectou.
- Você também pode tentar **colocar o hub em outro lugar** seguindo as orientações fornecidas na **página 261**. Se isso não funcionar, você precisará aproximar o hub do alimentador (leia abaixo).
- Para colocar o hub mais perto, tente conectá-lo ao roteador usando um cabo Ethernet mais longo.
- Se o procedimento acima não funcionar, recomendamos comprar um "**adaptador de energia através do cabo Ethernet**". Ele será conectado a uma tomada normal e permitirá conectar o hub à Internet mais perto do alimentador.

Orelhas piscando alternadamente (vermelho ou verde)

O hub está tendo problemas para se conectar aos servidores Sure Petcare. Isso pode ser devido a uma conexão de Internet não confiável.

- Tente ligar e desligar o hub. Desligue-o da tomada, aguarde 30 segundos e ligue-o novamente. Se as orelhas ficarem em verde sólido por alguns minutos, o hub se reconectou.
- Se o procedimento acima não funcionar, verifique se o roteador da Internet está ligado e se a conexão com a Internet está funcionando corretamente com outros dispositivos.
- Se não estiver funcionando com outros dispositivos, tente desligar o roteador, aguarde 30 segundos e ligue-o novamente.
- Se o roteador estiver funcionando com outros dispositivos, tente reconectar o cabo Ethernet ao roteador e ao hub. Certifique-se de que ele esteja encaixado completamente, pois pode parecer conectado quando, na realidade, não está.

Se os problemas de conectividade persistirem, visite: surepetcare.com/hub-connectivity

Orelhas em vermelho sólido

O firmware do hub está sendo atualizado. Seja paciente e espere até que as orelhas do hub fiquem verdes. Isso não deve demorar mais de 2 minutos. Após a atualização do firmware ser concluída, será necessário reiniciar o hub. Nesse ponto, você verá a sequência de luzes de configuração. **Consulte a página 262.**

Notificações lentas

Se achar que algumas mensagens demoram para serem exibidas no aplicativo, é provável que o hub esteja trabalhando duro para se conectar ao Alimentador para animais de estimação com microchip Connect. Para melhorar a velocidade das mensagens, tente mover o hub para um local melhor, seguindo os conselhos fornecidos na **página 261**.

Alimentador para animais de estimação com microchip Connect

Se houver algum problema mecânico no alimentador, não tente consertá-lo. Entre em contato com nossa equipe de atendimento ao cliente. Consulte a **contracapa** para obter os detalhes de contato.

O alimentador não abre para o meu animal de estimação

- Verifique se os quatro sensores do arco estão limpos. **Consulte a página 273.**
- Verifique se as pilhas usadas são **alcalinas** de boa qualidade e se não estão gastas. Verifique se os sinais + e - das pilhas estão na orientação correta. **Consulte a página 263.**
- Afaste o alimentador de qualquer aparelho metálico ou elétrico. Se o alimentador ainda não abrir para o seu animal de estimação autorizado, continue lendo.
- Verifique se não há fontes óbvias de ruído elétrico na área, como luzes defeituosas piscando etc. Se achar que isso esteja ocorrendo, entre em contato com nossa equipe de atendimento ao cliente. **Consulte a contracapa para obter detalhes.**
- Se o procedimento acima não funcionar, verifique com seu veterinário para garantir que o microchip do seu animal de estimação está funcionando e se está localizado no local normal. Se o microchip mudou significativamente de lugar, será difícil de ler. Enquanto isso, você pode usar a etiqueta para coleiras RFID Sure Petcare fornecida. Anexe a etiqueta à coleira do animal de estimação e repita o processo "Adicionar um animal de estimação". **Consulte a página 267.**

Meu animal de estimação não se acostuma a usar o alimentador

- Repita o processo de treinamento, dando mais tempo para seu animal de estimação se sentir confortável entre cada etapa. **Consulte as páginas 271-272.**
- Se seu animal de estimação ainda ficar desconfiado com o alimentador, tente seguir as etapas em **surepetcare.com/cautiouspet** para comprovar se você não está forçando seu animal de estimação a se alimentar a qualquer momento.
- Avalie o ambiente onde seu animal de estimação se alimenta. Ele sempre se aproxima da tigela de um ângulo fixo? Ele fica desconfiado em estar de costas para a porta? Não existe uma orientação definida na qual o alimentador deve ser colocado, portanto, se você puder, mude-o de lugar para ajudar seu animal de estimação a se sentir mais confortável.
- Se o atraso da tampa (depois que o animal terminar de comer e recuar) não for adequado para ele, você poderá aumentar/diminuir o tempo necessário para que a tampa se feche no aplicativo Sure Petcare.

A tampa do alimentador não está fechando completamente

- Isso pode ser causado por restos de comida presos sob a tampa ou no mecanismo. Para garantir que a tampa continue fechando corretamente, é importante remover resíduos de alimentos das superfícies do alimentador. **Consulte as páginas 273-274.**
- Verifique se o alimentador não está no modo de treinamento. **Visite a página 271** para saber mais sobre o comportamento do modo de treinamento.

As luzes indicadoras de porção estão acesas, mas a tigela está vazia

Se, quando você abrir o alimentador, algumas luzes indicadoras de porção estiverem verdes, mesmo que não haja comida nas tigelas, isso indica que é necessário zerar. Para resolver esse problema, sempre pressione o botão Zerar antes de substituir a comida do seu animal de estimação.

Consulte as páginas 269-270.

As luzes indicadoras de porção não estão respondendo

- Lembre-se de que, se você não tiver definido o peso da porção no aplicativo Sure Petcare, as luzes indicadoras de porção não acenderão ao colocar a comida do seu animal de estimação.
- Além disso, resíduos presos ao redor dos braços de pesagem podem afetar o desempenho do alimentador, portanto, verifique se esta área está limpa. **Consulte as páginas 273-274.**

Outros animais de estimação estão roubando comida

- Se outros animais de estimação gulosos estiverem tentando roubar comida de um alimentador aberto, tente reduzir o tempo que a tampa leva para fechar após o animal terminar de comer no aplicativo Sure Petcare.
- Pode haver uma configuração personalizada que ajude a resolver esse problema específico. Entre em contato com nossa equipe de atendimento ao cliente para comentar sobre sua situação. **Consulte a contracapa para obter detalhes.**
- Como alternativa, se outros animais de estimação gulosos conseguirem roubar comida, através da parte traseira ou lateral do alimentador (quando a tampa estiver aberta e o animal autorizado estiver comendo), criamos uma tampa traseira que ajudará a impedir esse comportamento. Para obter mais informações, acesse surepetcare.com/accessories.

Duração curta das pilhas

- Verifique se o alimentador está limpo e se não há sujeira tampando os sensores. **Consulte a página 273.**
- Verifique se usou pilhas de boa qualidade e se estão encaixadas corretamente. **Consulte a página 263.**
- Verifique se não há fontes óbvias de ruído elétrico na área, como luzes defeituosas piscando etc. Se achar que isso esteja ocorrendo, entre em contato com nossa equipe de atendimento ao cliente. Consulte a **contracapa** para obter detalhes.

Vários alimentadores em uma casa

- Se você ou seus animais de estimação ficarem confusos com os alimentadores, tente usar tigelas de cores diferentes, bem como locais de alimentação o mais distante possível. Isso deve ajudar. Tigelas e esteiras de cores diferentes são vendidas separadamente. Para obter mais informações, acesse surepetcare.com/accessories.

Ainda precisa de assistência?



- Se os problemas de conectividade persistirem, visite: surepetcare.com/hub-connectivity
- Para obter mais orientações, vídeos e fóruns de ajuda ao cliente, visite: surepetcare.com/support
- Se estiver tendo problemas com o aplicativo Sure Petcare, visite: surepetcare.com/apphelp

Ou você pode entrar em contato com nossa simpática equipe de atendimento ao cliente.

Consulte a contracapa para obter detalhes.



Garantia e isenção de responsabilidade

Garantia: O Alimentador para animais de estimação com microchip Connect SureFeed possui uma garantia de 3 anos a partir da data da compra, sujeito ao comprovante da data da compra. A garantia limita-se a qualquer falha causada por materiais, componentes ou fabricação defeituosos. Esta garantia não se aplica a produtos cujo defeito foi causado por desgaste normal, uso indevido, negligência ou dano intencional. No caso de uma falha na peça devido a peças defeituosas ou ao acabamento, a peça será substituída gratuitamente apenas durante o período de garantia. A critério do fabricante, um produto de substituição pode ser fornecido gratuitamente no caso de um defeito mais grave. Os seus direitos legais não são afetados.

Isenção de responsabilidade: O Alimentador para animais de estimação com microchip Connect e o aplicativo informam o consumo de ração, detectando o ID do microchip de um animal de estimação e medindo o peso da tigela antes e depois de terminar de comer. Na maioria dos casos, isso fornecerá dados confiáveis sobre o consumo de ração, no entanto, o uso inesperado ou irregular do alimentador (ou seja, um animal de estimação que remova a tigela ou brinca com alimentos) pode levar a informações não confiáveis. A Sure Petcare não se responsabiliza por quaisquer danos, prejuízos ou inconvenientes que possam ocorrer como resultado de relatórios incorretos do consumo de alimentos para animais.

O Alimentador para animais de estimação com microchip Connect SureFeed incorpora recursos de acesso seletivo que foram projetados para minimizar o risco de animais de estimação comerem alimentos uns dos outros. No entanto, não é possível garantir totalmente a exclusão de todos os outros animais de estimação em todas as circunstâncias. No caso raro de um animal de estimação não autorizado ter acesso ao alimentador, a Sure Petcare não se responsabiliza por qualquer dano ou inconveniente que possa ocorrer.



Descarte de produtos e baterias usadas: Este ícone indica produtos sujeitos à seguinte legislação:

A Diretiva de Resíduos de Equipamentos Elétricos e Eletrônicos 2012/19/UE (Diretiva WEEE), a Diretiva de Baterias 2006/66/EC (conforme emendada em 2013/56/UE) requer que as famílias descartem os resíduos de baterias e produtos EEE que chegaram ao fim de sua vida útil de uma maneira ambientalmente responsável. Para reduzir o impacto no meio ambiente, esses não podem ser colocados em lixeiras domésticas e devem ser reciclados em uma unidade de reciclagem apropriada. Mais informações sobre reciclagem podem ser encontradas em: www.recycle-more.co.uk.

Certifique-se de que as pilhas sejam substituídas antes do prazo de validade indicado na embalagem ou na própria pilha e descartadas de forma segura e adequada.

Em caso de vazamento da pilha, use roupas de proteção apropriadas para se proteger de qualquer exposição a produtos químicos nocivos antes de descartar as pilhas e limpar qualquer derramamento. Ao limpar um derramamento, evite o contato com a pele. Os produtos químicos das pilhas não devem ser colocados perto dos olhos nem ingeridos. Entre em contato com um profissional médico imediatamente se isso ocorrer.

Marcas comerciais: Google Play e o logotipo do Google Play são marcas comerciais da Google Inc. Apple, é uma marca comercial da Apple Inc., registrada nos EUA e em outros países. App Store, é uma marca de serviço da Apple Inc., registrada nos EUA e em outros países. IOS é uma marca comercial ou marca registrada da Cisco nos EUA e em outros países e é usada sob licença.



SURE[™]
PETCARE

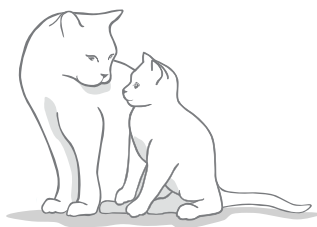

CN 欢迎使用 Microchip Pet Feeder Connect

感谢您选择 Microchip Pet Feeder Connect!

Microchip Pet Feeder Connect 系统由三个相互关联的组件构成,可以使您与宠物保持联系,并提供有关其进食习惯的更多信息。

Microchip Pet Feeder Connect 是系统的主要组件。它可以识别已植入宠物的微芯片 ID 或 Sure Petcare 射频项圈标签 (随附一个),根据识别结果挡住其他动物,只让您的宠物可以进食。

集线器 (须另购) 是系统的连接组件。它可以连接到您家中的互联网,并且可以与喂食器和 Sure Petcare 应用程序进行通信。

使用 **Sure Petcare 应用程序**,您将能够监控宠物的食量和进食频率。该应用程序还允许您将食物定量发送到喂食器,从而控制每次喂食的量。

物品清单

请确保您拥有所有这些部件*

- 1 1 台 Microchip Pet Feeder Connect
- 2 1 只单碗
- 3 2 只半碗
- 4 1 张碗垫
- 5 1 个单碗碗托
- 6 2 个半碗碗托
- 7 1 个 Sure Petcare 射频项圈标签

*不包含电池和集线器

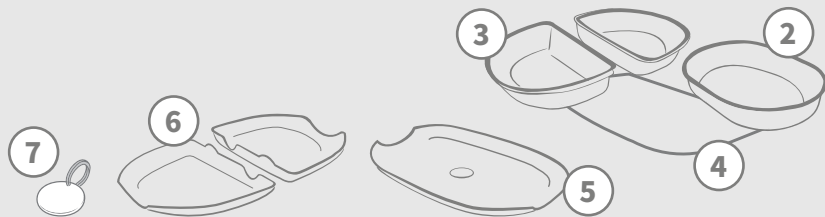
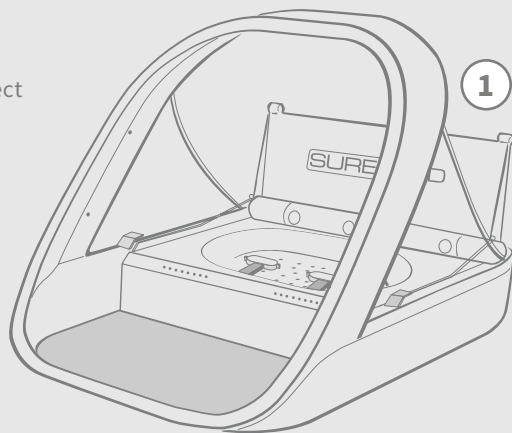

为使 Microchip Pet Feeder Connect 组成互联系统工作,您需要购买配套的集线器。有关如何购买集线器的更多信息,请访问 surepetcare.com/hub。

目录

重要须知	284
产品概述	286
Microchip Pet Feeder Connect 系统.....	288
集线器	
设置集线器	289
集线器的摆放位置.....	290
集线器指示灯	291
喂食器	
电池	292
连接喂食器.....	293
按钮和指示灯	294
向喂食器添加宠物.....	296
设置食份	297
添加和更换食物	298
训练模式	300
清洁与保养.....	302
帮助与支持.....	304
质保和免责声明.....	308



重要须知



请仔细阅读以下信息并保留本手册以供将来参考。



本产品**仅适用于家养宠物**。



仅使用 SureFeed 附件以确保兼容性:
surepetcare.com/accessories



确保您拥有第 281 页上列出的所有部件。



勿将喂食器放在人员走动频繁的区域。



喂食器**仅供室内使用**。



切勿将喂食器浸入水中或在水龙头下冲水。



切勿将喂食器放入冰箱或在喂食器内部或下方放置冰袋。



切勿将喂食器放置在过热的地方。



该产品需要使用 **4 节二号电池**，请小心安装和更换电池。勿将不同类型电池或新旧电池混合使用。如果喂食器长时间不使用，请取出电池。

您可以在产品底部找到 Microchip Pet Feeder Connect 的**产品代码和序列号**。

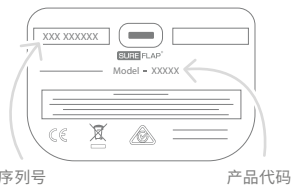

安全警告

- 如有部件丢失、损坏或磨损，切勿使用本产品。
- 本产品包含一些小组件。任何松动部件都应远离儿童和宠物存放，**避免误食产生窒息危险**。

其他注意事项



宠物: Sure Petcare 建议将 SureFeed Microchip Pet Feeder Connect 与宠物的植入微芯片配合使用,当然也可以与 Sure Petcare 射频项圈标签配合使用。如使用项圈标签,应使用**带有安全扣**(仅限于猫)的安全项圈。对于因宠物项圈造成的任何伤害或死亡, Sure Petcare 概不承担责任。



进食: 对于因使用不当而导致其他未经允许的宠物进食, Sure Petcare 概不承担责任。您作为本产品的所有者, **应全权负责宠物食物管理**,并对其他宠物因无意中食用这些食物所可能造成的伤害承担全部责任。



无计时器功能: 本产品不包含计时器,并且不具有任何与时间相关的功能。因此,请不要单独留下宠物无人看管,也不要依赖本产品看管宠物时间过长:猫不要超过 24 小时,狗不要超过平均两餐间隔时间。**该产品不能替代宠物主人的看管责任。**



儿童: 不允许让儿童玩耍 SureFeed Microchip Pet Feeder Connect。它不是玩具,也不应当作儿童的玩具。但本产品可以供 8 岁及以上儿童使用,也可以由残障人士(肢体、感觉或精神障碍)使用,前提是有人监管其使用或告知其安全使用注意事项。应始终明确告知他们任何可能存在的危害。不允许任何年龄儿童在无人监管情况下清洁本产品。



儿童防护: 在有儿童的家庭中,必须将 SureFeed Microchip Pet Feeder Connect 纳入**儿童安全保护考虑范围**。儿童不当使用本产品可能会带来潜在危险。因此,儿童在喂食器附近逗留时应始终有人监管。另请注意,当喂食器处于**训练模式**(参见第 299-300 页)时,儿童仍可以接触到宠物食物。



产品概述

Microchip Pet Feeder Connect 系统由三个主要组件构成：

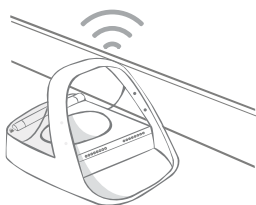

Microchip Pet Feeder Connect



集线器

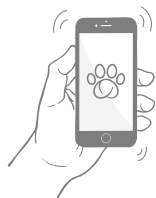

Sure Petcare 应用程序

集线器通过网线连接到互联网，并监控 Microchip Pet Feeder Connect 的活动。它可以与喂食器和 Sure Petcare 应用程序通信，即使您不在家中，也可以在 Sure Petcare 应用程序上查看最新状况！

您还可以在应用程序中设置食份量。设置好后，喂食器将在您添加食物时进行引导，确保您的宠物得到正确的份量。如需了解详情，请参见第 294 页。

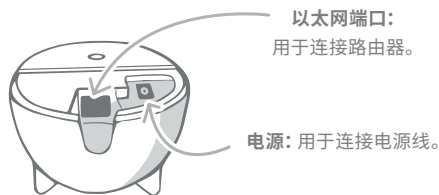
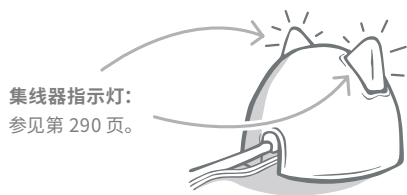
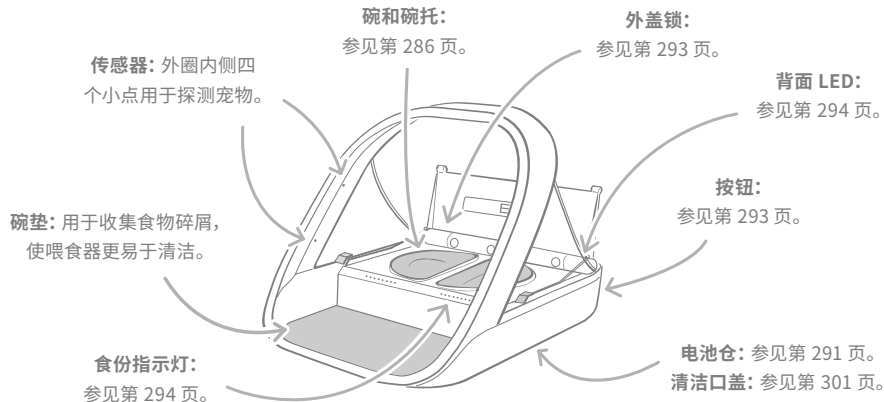

SureFeed 的碗边装有密封圈，有助于延长宠物食物保鲜时间。如果您只给宠物喂一种食物，可以使用单碗；如果给它们同时喂湿粮和干粮，那么使用两个半碗再好不过了！



单碗：可以装盛 250 克，足以容纳至少 2 袋湿粮。



半碗：每只最多装盛 100 克，两只最多装盛 200 克。

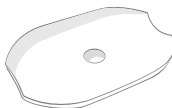

单碗碗托：用于放置单碗，而不是半碗。



半碗碗托：各用于放置一只半碗，而不是单碗。

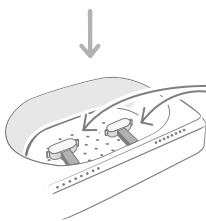

称重臂：用于放置碗托。

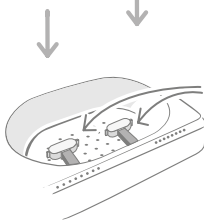

称重臂：用于放置碗托。



切勿将宠物食物直接放在碗托上。务必用碗装盛食物，确保喂食器正常工作。

SureFeed 分碗不适用于 Microchip Pet Feeder Connect。

要购买更多碗或碗垫，请咨询 Sure Petcare 经销商或访问 surepetcare.com。

多种颜色



SureFeed 塑料碗和碗垫有四种不同颜色：
蓝、绿、粉红和灰色。

可选材质

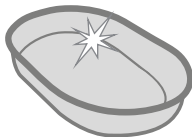

可另购 SureFeed 不锈钢材质单碗。



切勿将碗放入洗碗机或微波炉中。



首次用碗前请手动洗净。



Microchip Pet Feeder Connect 系统

立即下载下载 Sure Petcare 应用程序

APP STORE
下载

下载应用, 请到
GOOGLE PLAY



surepetcare.io



当宠物从喂食器进食时收到通知。



监控宠物进食情况并观察其行为变化。



准确分配食物以控制每次喂食量。



与家人和朋友共享“家庭”的访问权限。



下载 **Sure Petcare 应用程序** 并创建帐户。系统会要求您创建一个“家庭”，即包含您所有 Sure Petcare 互联产品及宠物的互联环境。您可以邀请其他家庭成员加入您的“家庭”。

要下载该应用, 您的手机或平板电脑必须至少运行 **Apple iOS 9**, 或 **Android 4.4** 版本。



如果想通过电脑控制 Sure Petcare 互联产品, 您可以使用 Sure Petcare 网页应用程序, 网址 **surepetcare.io**。

浏览器需使用最新版的 **Safari**、**Chrome**、**Firefox** 或 **Internet Explorer**, 系统要求为 **Mac OS X v10.9** (或更高版本) 或 **Windows 7** (或更高版本)。

购买 Sure Petcare 集线器



若要通过 Sure Petcare 应用程序使用 Microchip Pet Feeder Connect, 您需要购买配套的集线器。如需了解详情, 请访问 **surepetcare.com/hub**。



设置集线器

成功下载 Sure Petcare 应用程序后，您需要为集线器接上网线和电源，并进行设置。设置好集线器后，系统会要求您将其连接到喂食器和应用程序。请按照以下步骤操作：

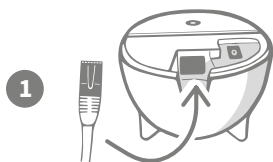

1

将网线一端插入集线器底部，另一端插入路由器上的空闲以太网端口。



2

连接电源并将其插入插座。将电源线另一端插入集线器底部。

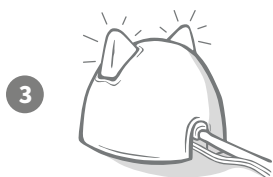

3

集线器的“双耳”将开始交替闪烁红色和绿色。待“双耳”绿色长亮，即表示集线器准备就绪。如果“双耳”未按此顺序显示指示灯，请参见第 290 页以了解详情。



4

若要完成 Microchip Pet Feeder Connect 系统的设置，您需要按照 Sure Petcare 应用程序上的其余步骤进行操作。



您的集线器可能会收到软件更新。如果“双耳”在设置时显示红灯长亮，请勿惊慌，这表明集线器正在更新软件。完成后集线器将重新启动您将看到第 3 步中详述的指示灯顺序。



集线器的摆放位置

由于 Microchip Pet Feeder Connect 系统使用无线通信,因此集线器的位置可能会影响其性能。



集线器应放置在离地面至少 1 米的地方,比如没有障碍物遮挡的桌子上。

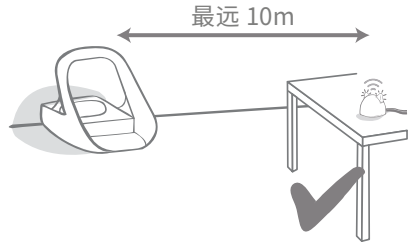

集线器应放置在喂食器视线范围内,距离不要超过 10 米。

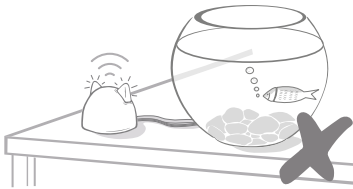

集线器附近或视线范围内请勿放置有大量水的物体(例如鱼缸)。

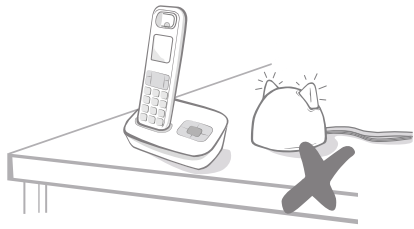

集线器尽可能远离任何潜在干扰源(例如数字无绳电话、婴儿监视器等)。



集线器切勿放置在任何大型金属物体(例如冰箱)旁边。

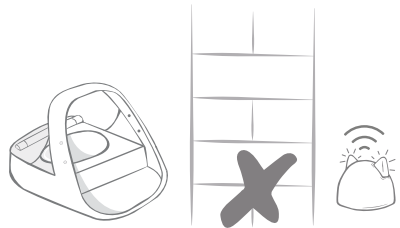

集线器与喂食器之间切勿有厚墙相隔。



即使按照上述要求操作,集线器有时仍可能会遇到信号不良问题。有关如何将集线器靠近 Microchip Pet Feeder Connect 的更多建议,请访问 surepetcare.com/hub-connectivity。



如果集线器出于任何原因失去互联网连接, Microchip Pet Feeder Connect 仍可正常运行并保留其设置。



集线器指示灯

集线器使用“双耳”指示灯显示其当前状态。不同颜色的指示灯顺序表示不同的状况。

准备指示灯

集线器每次开机或尝试连接系统其他组件时，会显示以下准备指示灯：

- 1 “双耳”会先交替闪烁红色一段时间，
 
- 2 然后会交替闪烁绿色，
 
- 3 如果“双耳”同时闪烁橙色，然后变为绿色长亮后，表明集线器已成功连接。
 

双耳绿色

双耳绿色表示集线器工作正常。如需详细了解各个指示灯顺序的含义，请参见下文。

双耳绿色长亮：集线器已开启、连接并正常工作。

双耳交替闪烁绿色：集线器正在重新连接服务器。

双耳红色

双耳红色长亮：集线器正在执行软件更新。请稍等片刻，集线器很快将重新启动并恢复正常。

双耳同时闪烁红色：集线器已断开与喂食器的连接，正在尝试重新连接。

双耳交替闪烁红色：集线器无法连接到互联网和 / 或服务器。

i 如需详细了解故障排除，请参见第 304 页。



电池

务必使用 4 节优质 1.5V 二号碱性电池，确保 Microchip Pet Feeder Connect 保持最佳性能。
本产品不建议使用充电电池。安装或更换电池时，请按照以下步骤操作：



喂食器背面有一个指示灯。如果电池电量不足，或者电池安装不当，该指示灯会闪烁红色，每 5 秒一次。

1

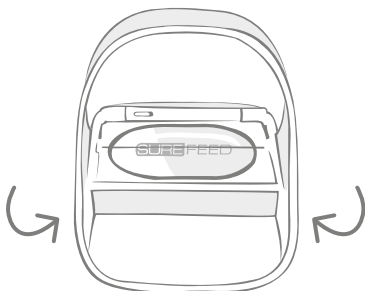

翻转喂食器，找到电池仓。

2

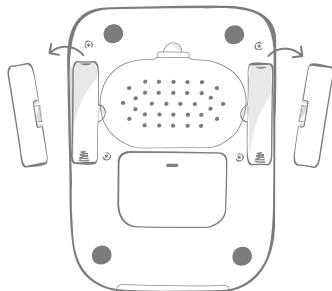

取下电池盖。

3

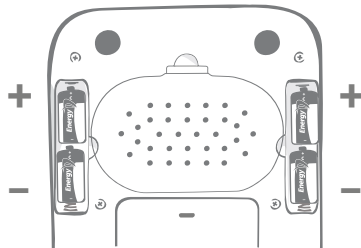

安装电池。确保电池正负极与喂食器上的 +/- 符号一致。

4

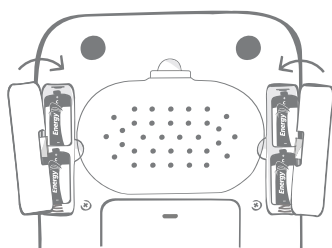

盖好电池盖。



将宠物的微芯片 ID 编程到喂食器中后，它将永久存储在内存中。即使在更换电池后，喂食器仍会识别您授权的宠物。



连接喂食器

为完成互联系统设置，您需要将喂食器连接到您的“家庭”。

1

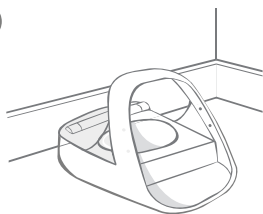

将喂食器放置在合适的位置，确保喂食器与集线器正常通信。

2



在 Sure Petcare 应用程序中选择“添加产品”。

3



集线器将进入连接模式，机身耳朵将闪烁绿色。

4

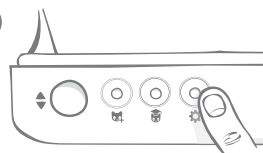

点按一次喂食器上的设置按钮 。LED 耳朵指示灯将呈绿色亮起。

5

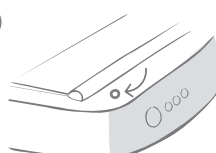

连接喂食器后，LED 指示灯会熄灭，集线器也会停止闪烁。

i

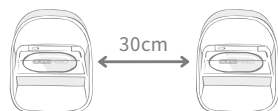

如果要连接多台喂食器，可在应用程序内轻松完成操作。

添加喂食器到当前的“家庭”



您可以通过应用程序将 Microchip Pet Feeder Connect 添加到现有的 Sure Petcare “家庭”。转到“家庭”部分，然后按照上述说明进行操作。

您还可以通过应用程序远程分配宠物的微芯片 ID，无需手动添加。但在添加宠物时，使用零食诱导可以激励宠物习惯使用新产品。如需详细了解如何添加宠物，请参见第 295 页。



按钮和指示灯

按钮

喂食器上有 5 个按钮，全都位于产品背面：

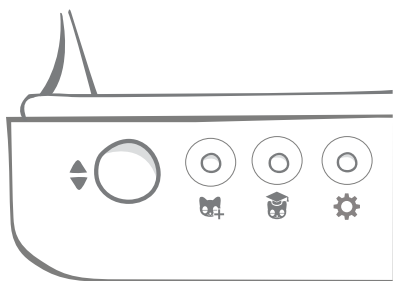

打开 / 关闭按钮： 打开和关闭外盖以便取放碗。



添加宠物按钮： 将宠物的微芯片 ID 添加到喂食器中 (参见第 295 页)。



训练模式按钮： 激活训练模式，训练宠物习惯使用喂食器 (参见第 299-300 页)。



设置按钮： 连接喂食器和集线器 (参见第 292 页)。



清零按钮： 校准喂食器，确保喂食量正确 (参见第 297 页)。此按钮会将喂食器双侧清零，无论使用的是单碗还是两个半碗。



使用半碗时，您可以通过 **Sure Petcare 应用程序** 进行单侧清零。

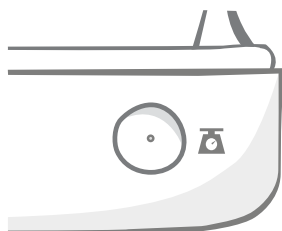

外盖锁



已锁定： 表示外盖无法从喂食器上拉出并取下。



已解锁： 外盖处于打开位置，可以拉出并取下。

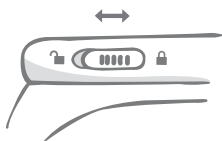

外盖锁应始终保持**锁定**状态，仅在需要开盖清洁时才解锁。这样也可以防止其他未经授权但机灵异常的宠物开盖取食。**请注意，锁定盖子不会**影响其正常开启。

背面 LED

绿灯长亮。授权宠物每次从喂食器进食时，绿灯就会亮起。

绿灯闪烁。喂食器处于“添加宠物”模式（参见第 295 页）。指示灯将继续闪烁，直到成功添加微芯片或退出此模式为止。

橙灯闪烁。喂食器处于训练模式（参见第 299-300 页）。闪烁次数与训练所处阶段有关。

红灯闪烁。电池电量不足。

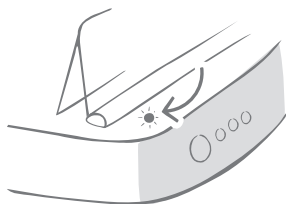

食份指示灯

如果您在 Sure Petcare 应用程序中设置了食份量，则在添加食物时，喂食器前面的指示灯会起到指导作用。

食份指示灯将指示已添加的食物量，确保宠物获得正确的食份。

如需详细了解精确配食的好处，请参见第 296 页。

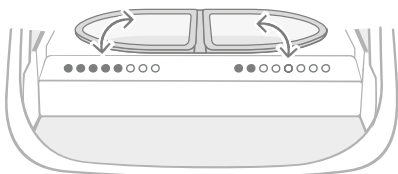
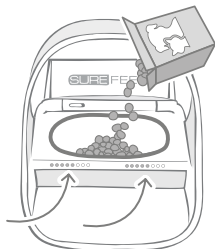

使用半碗

喂食器左右两侧的指示灯分别对应左右两个半碗。在某一侧添加食物时，相应的指示灯会亮起。

使用单碗

在单碗中添加食物时，两侧指示灯会同时亮起。

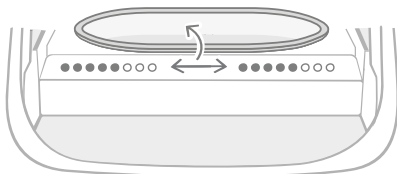

若要从半碗切换成单碗，或从单碗切换成半碗，您需要通过 Sure Petcare 应用进行更改。



如果未在应用程序中设置食份量，则在向喂食器添加食物时，指示灯不会亮起。



向喂食器添加宠物

向 Microchip Pet Feeder Connect 添加宠物的微芯片 ID 时, 请确保远离所有其他宠物以及任何不需要的项圈标签。

1

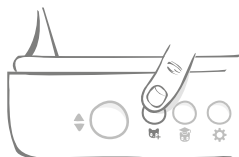

点按产品背面的“添加宠物”按钮。

2

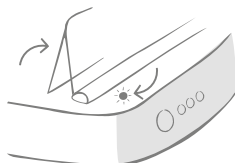

外盖将打开, 背面的 LED 指示灯会闪烁绿色, 每秒一次。

3

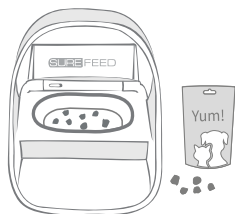

将一些食物 / 零食放入碗中, 然后将喂食器放置在通常喂食宠物的地方。

4

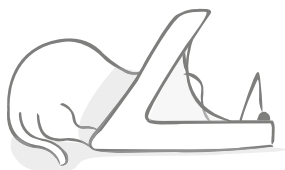

当宠物进食时, 喂食器会扫描其微芯片 ID。ID 添加后, LED 指示灯将停止闪烁(但保持长亮)。

5

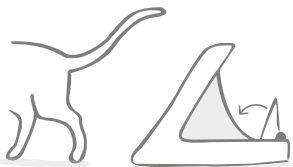

宠物离开后, 盖子将关闭, 绿色 LED 指示灯也会熄灭。此时微芯片 ID 已永久存储于系统中。

i

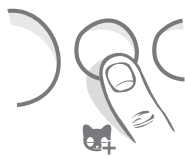

如有需要, 您可随时再次按下“添加宠物”按钮来取消“添加宠物”模式。



若要对宠物的微芯片 ID 进行编程, 位于喂食器外圈上的传感器必须检测到宠物的存在。因此, 必须确保宠物将头伸进外圈进食。



若要对 Sure Petcare 射频项圈标签进行编程, 只需按照上述步骤操作并将项圈标签保持在在外圈内即可。对项圈标签进行编程时, 请勿佩戴任何金属首饰。



如果您的 Sure Petcare “家庭”中已有宠物, 则可以将其分配给喂食器。转到应用程序中的“家庭”部分。如果不慎加错了宠物, 您可以随时在此处更正。



设置食份

Microchip Pet Feeder Connect 不仅可以监视宠物的进食时间和食用的食物，还可以在您每次投喂时帮您掌握准确的份量。

为什么要设置宠物的食份？

减轻宠物体重有什么好处？设置食份量，可以确保宠物每天不会无意中进食过多。日积月累也不可小视！

直接在喂食器为食物称重，则可以更快更方便地确保宠物食量正确。

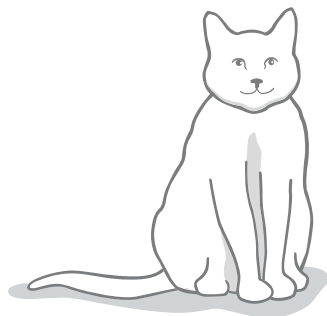

如何确定正确的宠物食量？

很难知道宠物的正确食量应该是多少，尤其是现在宠物食品选择太多的情况下。我们建议您咨询兽医或动物健康顾问，

或者遵循宠物食品包装上的制造商说明。这些信息对于一般、健康的宠物还是比较可靠的。

如何在应用程序中设置食份量

您可以在 Sure Petcare 应用程序中设置食份量。设置好的食量会发送到喂食器，让其知道每餐应投喂的食物量。

喂食器上的食份指示灯将在您添加食物时进行引导，确保投喂量正确。指示灯会指示所添加的食物量，有关更多信息，请参见第 298 页。





添加和更换食物

请务必每天更换宠物食物，这不仅是为了保持宠物快乐和健康，也是为了保持喂食器的清洁和正常使用。

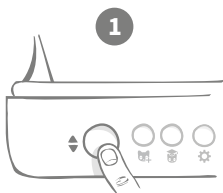

1 点按“打开/关闭”按钮 (↕)。



6 当所有指示灯闪烁绿色时，表示您已经达到份量定量。



2 取出脏碗和任何碎屑。清洗干净或更换新的。



5 在清零亮灯顺序之后，在碗中投放食物。食份量指示灯将依次亮起以显示碗中的食物量 (参见下页)。

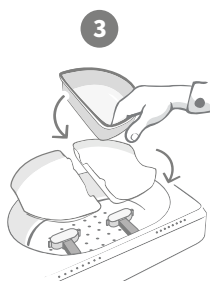

3 确保将对应的单碗或半碗碗托正确地放在称重臂上，并将空碗放在上面。

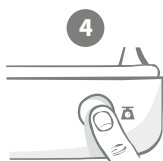

4 在碗中投放食物之前，点按清零按钮，确保宠物得到相应的食份量。请记住，点按此按钮会将喂食器双侧清零 (参见第 293 页)。

食份指示灯



清零亮灯顺序:

点按清零按钮后,绿色指示灯会从右到左依次熄灭。



添加食物:

添加食物时,绿色的食份指示灯会从左到右依次亮起。指示灯数量对应碗中的食物量。您需要继续添加食物,直到所有指示灯闪烁。



达到食份量:

当食份量处于 $\pm 1g$ 范围内时,指示灯将**闪烁绿色**。如果指示灯没有闪烁,则说明还没有达到定量。



过量:

如果在碗中添加的食物重量超过定量,**红灯**会提示您超过了多少量。只需取出一些食物,直到看到绿灯闪烁为止。



请注意,如果未在应用程序中设置食份量,则在向喂食器添加食物时,食份指示灯**不会亮起**。

碗里还留有食物?

如果到了喂食时间碗中还留有食物,无需点按清零按钮,只需在喂食器中继续添加食物即可,您可以在碗中现有食物的基础上添加新的食份。达到食份量时,食份指示灯会作出相应指示。

1

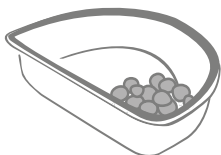

当您打开外盖时,部分指示灯会短暂闪烁,表示喂食器知道碗中还有食物。所有指示灯随后会熄灭,让您在剩余食物之上添加新的食份。

2

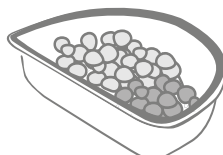

在碗中投放食物,直到所有指示灯都闪烁绿色。



训练模式

(训练宠物使用喂食器)



当使用“打开 / 关闭”按钮打开时，橙色训练指示灯将闪烁红色，帮助您确定已点按“打开 / 关闭”按钮并且喂食器处于打开模式。添加相应食份并再次点按“打开 / 关闭”按钮后，训练指示灯会恢复为橙色。**如未点按“打开 / 关闭”按钮，则食份指示灯不会激活，系统将无法识别您正在添加食物。**

第一部分：让宠物适应喂食器

一些宠物可能需要一段时间才能适应喂食器。在训练模式中，您可以逐渐增加外盖的动作，让宠物慢慢提升使用新碗的信心。这可能需要一些时间，但不要着急；在宠物适应之前，不要开始**第二部分**。

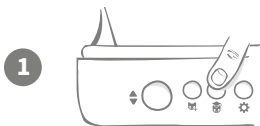

1

在外盖关闭的情况下，点按喂食器背面的“训练模式”按钮（）。此时外盖将打开，背面的 LED 指示灯会闪烁橙色，数秒一次。

2

在碗中放入宠物最喜欢的食物，然后将喂食器放在宠物正常进食或感觉舒适的地方。



3

在第一阶段训练中，宠物进食完毕后**外盖不会关闭**。



请记住要花些时间让宠物适应新碗。待宠物适应后，开始进行**第二部分**。

第二部分：增加盖子的开关动作

逐步增加盖子的开关动作，让宠物分三个阶段进行适应。再次重申，为获得最佳效果并让宠物感到适宜，请务必保持耐心，不要急于求成。每只宠物在各个阶段所需的时间可能有所不同（数天或数周），我们建议每个阶段要花上几天时间。

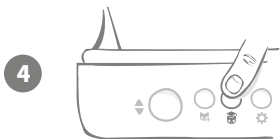

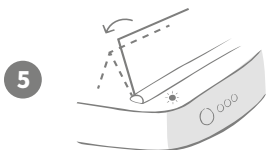

4

再次按下“训练模式”按钮（），开始增加外盖的动作。此时外盖会关闭稍许，背面的 LED 指示灯会闪烁橙色两次。





5



现在，当宠物从碗里进食时，盖子在完全打开的过程中会有些动作。宠物进食完毕后，外盖会缓慢关闭。

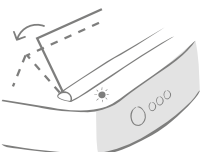

- 6**  多花一些时间让宠物习惯外盖的新动作。需要更换食物时，请照常操作（参见第 297 页）。更换食物后，请点按“打开 / 关闭”按钮（）将外盖关闭到训练位置。

 请记住要花些时间。在宠物习惯这种外盖动作之前，请勿继续进行下一阶段。

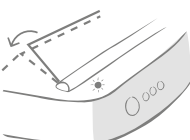
- 7**  宠物习惯此动作后，再次点按“训练模式”按钮（）。此时外盖会关闭到下一个位置，背面的 LED 指示灯会闪烁橙色三次。

 再次重申，请继续正常使用喂食器，在宠物习惯这种外盖动作之前，请勿继续进行下一阶段。

- 8**  宠物现在应该已经习惯了外盖的动作，因此在训练的最后一阶段，外盖会进一步关闭。和之前一样，再次点按“训练模式”按钮（）。此时外盖会关闭到最终位置，背面的 LED 指示灯会闪烁橙色四次。

- 9**  在宠物习惯最终位置后，再次点按（）。此时外盖会完全关闭，背面的 LED 指示灯不再闪烁。喂食器现在会密封，处于日常使用模式。



您可以随时长按“训练模式”按钮（）5 秒来结束训练模式。



如果需要后退至上一步，请按照上述提示进行操作，这会使喂食器退出训练模式，然后您可以从头开始该过程。



如果宠物对外盖关闭感到紧张，您可以在 Sure Petcare 应用程序中调整外盖关闭前的等待时长。



清洁与保养

请务必保持 Microchip Pet Feeder Connect 清洁, 确保其可靠运行。
切勿将喂食器整体浸入水中或在水龙头下冲水。喂食器进水可能会导致其本身或电子元件损坏。

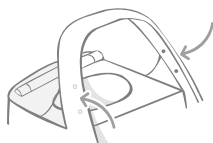
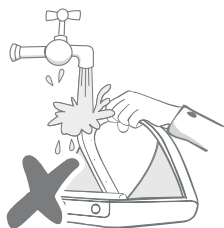

确保外圈上的四个黑点始终保持清洁。可以使用湿布将碗垫擦拭干净。
请勿将物品放入洗碗机中。仅能手洗。

Microchip Pet Feeder Connect 的底部有一个清洁口盖, 方便您清除碎屑或残渣。

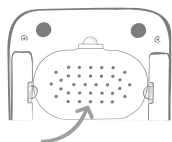

如何取下外盖进行清洁

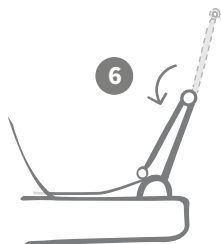

现在将外盖上半部分翻折下来,
将其搁在转动轴上。

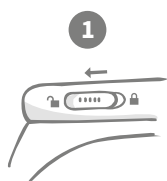

将外盖锁滑至解锁位置。

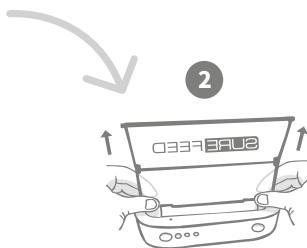

点按 (◀▶) 按钮。
外盖打开后, 向上拉起。

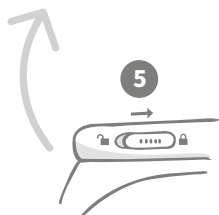

将外盖锁滑回至锁定位置。

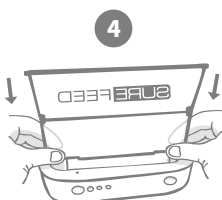

清洁后, 重新装上盖子, 两个半片都保持垂直。
确保安装牢固。

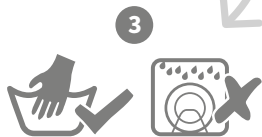

仅能手洗。
切勿放入洗碗机中。

如何确保喂食器清洁

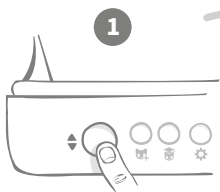

1

点按“打开/关闭”按钮(◊)。

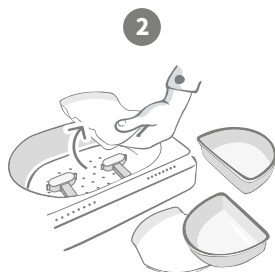

2

取出碗、碗托和外盖(参见上一页)。



7

重新安装所有部件,务必先安装清洁口盖。

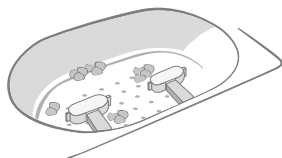

3

卡在称重臂周围的食物碎屑会影响喂食器的性能,因此请务必保持清洁。
请勿使用任何磨料海绵,否则会损坏喂食器并导致其无法正常工作。



6

请使用湿布清洁喂食器表面。
请勿使用任何磨料清洁产品。

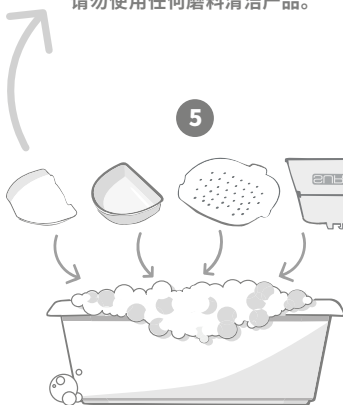

5

手洗所有可拆卸的部件。
切勿放入洗碗机中。

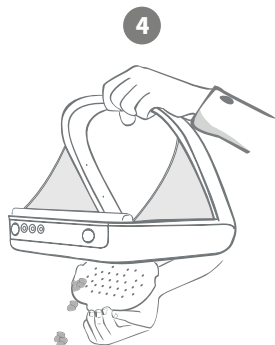

4

手持喂食器置于垃圾箱上方,取下清洁口盖,抖落其中的食物碎屑。



帮助与支持

自定义设置

我们知道并非所有宠物的行为都相同，因此 Microchip Pet Feeder Connect 的设计也考虑到了这一点。喂食器包含多种自定义设置，旨在帮助宠物以非预期或非常规的方式使用喂食器。

以下动物行为示例可通过自定义设置来克服：

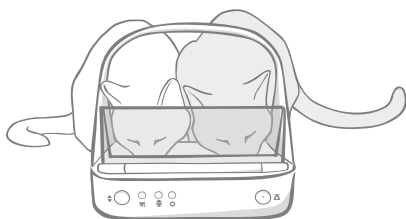

未经授权的宠物是否会在授权宠物进食时挤进去抢食？

我们有自定义设置可以解决此问题！

未经授权的宠物是否喜欢趁另一只宠物喂食器处于训练模式时从中偷食？

我们有自定义设置可以解决此问题！

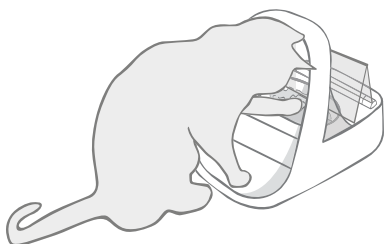

是否有未经授权但机灵异常的宠物找到了阻止外盖关闭的方法？

我们有自定义设置可以解决此问题！

未经授权的宠物是否会尝试从喂食器背面偷取食物？

我们有配件可以解决此问题！

转到 surepetcare.com/accessories，然后查找“后盖”。

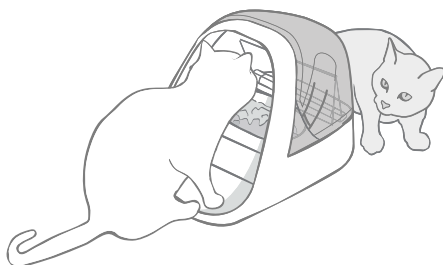

如需咨询自定义设置的相关问题，请联系客户服务团队（**联系信息请参见封底**）。他们会根据您的情况推荐最合适的自定义设置，并为您进行远程设置。

集线器

双耳闪烁红色

集线器与 Microchip Pet Feeder Connect 失去连接。

- 如果**双耳在设置过程中闪烁红色**，请长按集线器底部的按钮 10 秒钟以恢复出厂设置。
- 如果**双耳在设置完成后长时间闪烁红色**，请尝试重启集线器。断开插座电源，等待 30 秒后再重新接通。如果双耳保持绿色长亮数分钟，表示集线器已重新连接。
- 您也可以尝试**更改集线器位置**，步骤请参见第 289 页。如果此方法无效，则需要将集线器移到靠近喂食器的位置（请阅读下文）。
- 为了使集线器更靠近，请尝试使用更长的网线将其连接到路由器。
- 如果上述方法无效，建议您购买“**电力猫**”（Ethernet over power adapter）。该设备可插入普通电源插座，方便将集线器从靠近喂食器的位置连接到互联网。

双耳交替闪烁（红色或绿色）

集线器无法连接 Sure Petcare 服务器，原因可能是互联网连接不稳定。

- 请尝试重启集线器，即断开插座电源，等待 30 秒后再重新接通。如果双耳保持绿色长亮数分钟，表示集线器已重新连接。
- 如果以上方法均无效，请确保您的互联网路由器已打开，并且其他设备上的互联网连接正常。
- 如果其他设备上也无效，请尝试关闭路由器，等待 30 秒后再重新打开。
- 如果其他设备上的网络正常，请尝试重新连接路由器和集线器的网线。确保网线插入到位，有时看起来是插着，但其实可能并没有插好。

如果仍然存在连接问题，请访问：surepetcare.com/hub-connectivity

双耳红色长亮

集线器正在进行固件更新。请耐心等待集线器双耳变为绿色。此过程应不会超过 2 分钟。固件更新完成后，集线器将需要重新启动。此时，集线器会显示准备指示灯顺序（参见第 290 页）。

通知滞后

如果在应用程序中发现某些消息显示滞后，则可能是由于集线器与 Microchip Pet Feeder Connect 的连接不稳定。为提高消息传输速度，请尝试更改集线器的位置，步骤请参见第 289 页。

Microchip Pet Feeder Connect

如果喂食器出现任何机械问题，请不要尝试自行修理，而应联系客服团队寻求帮助。**联系方式请参见封底。**

喂食器不对宠物打开

- 请确保外圈中的 4 个传感器清洁 (参见第 301 页)。
- 请确认您使用的是优质碱性电池,并且电量充足。确保电池的正负极方向正确(参见第 291 页)。
- 将喂食器远离任何金属或电气设备。如喂食器仍无法对授权宠物打开,请继续阅读。
- 检查区域内有无明显的电气噪声源,例如照明灯发生故障不断闪烁。如果您怀疑有电气噪声,请致电客户服务团队 (联系信息请参见封底)。
- 如果上述方法无效,请与兽医确认宠物的微芯片是否正常工作,并且位于正常位置。如果微芯片出现严重移位,则会很难读取。在此期间,您可以使用随附的 Sure Petcare 射频项圈标签。将项圈标签固定在宠物项圈上,然后重复“添加宠物”过程 (参见第 295 页)。

宠物不喜欢使用喂食器

- 重复训练过程,每个步骤多花些时间让宠物适应 (参见第 299-300 页)。
- 如果宠物仍对喂食器非常警惕,请尝试按照 surepetcare.com/cautiouspet 中的步骤进行操作,切忌强迫宠物进食。
- 评估宠物的进食环境。它们是否总是从某个固定角度靠近碗? 它们是否会害怕背对着门? 喂食器的摆放没有固定角度,所以在可能的情况下多变换下角度,帮助宠物适应。
- 如果外盖 (在宠物进食完毕并离开后) 的关闭延迟时间不适合,您可以在 Sure Petcare 应用程序中相应增 / 减延迟时间。

喂食器外盖没有完全关闭

- 原因可能是食物碎屑卡住了外盖或机械装置。为确保外盖正确关闭,请务必清除喂食器中的食物碎屑 (参见第 301-302 页)。
- 确认喂食器没有处于训练模式。如需详细了解训练模式行为,请查看第 299 页。

食份指示灯亮着,但碗空了

如果打开喂食器时,即使碗中没有任何食物,某些食份指示灯还是呈绿色亮着,这表明需要清零。要解决此问题,请确保在更换宠物食物之前点按清零按钮 (参见第 297-298 页)。

食份指示灯没有反应

- 请注意，如果未在 Sure Petcare 应用程序中设置食份量，则在添加食物时，食份指示灯不会亮起。
- 另外，卡在称重臂周围的食物碎屑也会影响喂食器的性能，因此请确保该区域清洁（参见第 301-302 页）。

其他宠物可以偷到食物

- 如果其他贪婪的宠物试图从打开的喂食器中偷取食物，您可以尝试通过 Sure Petcare 应用程序减少宠物完成进食后的外盖关闭时间。
- 我们有自定义设置可能帮您解决此问题。如需咨询相关问题，请联系客户服务团队（联系信息请参见封底）。
- 或者，如果其他宠物能够从喂食器背面或侧面偷食（当外盖打开且授权宠物正在进食时），我们还可以提供一款后盖，帮助您防止这种情况发生。如需了解详情，请转至 surepetcare.com/accessories。

电池寿命短

- 确保喂食器清洁，并且传感器没有污物遮盖（参见第 301 页）。
- 确保使用优质电池，并且安装正确（参见第 291 页）。
- 检查区域内有无明显的电气噪声源，例如照明灯发生故障不断闪烁。如果您怀疑有电气噪声，请致电客户服务团队。联系信息请参见封底。

家里有多台喂食器

- 如果发现您自己或宠物分不清该用哪个喂食器，请尝试使用不同颜色的碗，或者使用不同的喂食位置，这样应该有所帮助。其他颜色的碗和碗垫须另购。如需了解详情，请转至 surepetcare.com/accessories。

仍然需要协助？



- 如果仍然存在连接问题，请访问：surepetcare.com/hub-connectivity
 - 有关更多指导、视频和客户帮助论坛，请访问：surepetcare.com/support
 - 如果在 Sure Petcare 应用程序使用过程中遇到问题，请访问：surepetcare.com/apphelp
- 您也可以联系客户服务团队，联系信息请参见封底。



质保和免责声明

质保: SureFeed Microchip Pet Feeder Connect 自购买之日起享有 3 年质保 (需出具购买日期证明)。本质保仅限于任何因材料、组件或制造等缺陷引起的故障。本质保不适用于因正常磨损、不当使用、疏忽或故意损坏而造成的产品故障。因部件或工艺问题导致的部件故障,在保修期内可免费更换部件。如发生更严重的故障,可以免费更换产品,具体由制造商全权决定。您的法定权利不受影响。

免责声明: Microchip Pet Feeder Connect 和应用程序通过检测宠物的微芯片 ID,然后称量宠物进食前后的碗重量,来报告宠物的进食量。在大多数情况下,这样可以提供可靠的宠物进食量数据,但若以非预期或非常规方式使用喂食器(例如宠物取下碗或拿食物玩耍),可能会导致信息不准确。对于因宠物进食量数据报告错误而造成的任何损害、伤害或不便, Sure Petcare 概不承担责任。

SureFeed Microchip Pet Feeder Connect 提供选择性进入功能,旨在最大程度地减少宠物之间彼此抢食的风险,但我们无法保证在所有情况下都能将其他宠物全部排除在外。若在极少数情况下,未经授权的宠物使用了喂食器, Sure Petcare 对可能造成的任何损害或不便概不承担责任。



产品和废弃电池的处置: 此图标表示产品受以下法规约束:

欧盟《废弃电子电机设备指令 2012/19/EU 号》(简称 WEEE 指令)和《电池指令 2006/66/EC 号》(修订版为 2013/56/EU 号)均规定了家庭以负责任的方式处置电子产品和废弃电池的义务。为减少环境影响,这类废弃产品不得放入生活垃圾箱中,而应送到相应的回收机构进行回收处理。有关回收的更多信息,请访问: www.recycle-more.co.uk。

确保按照电池或电池包装上的有效期更换电池,并安全妥善处置。

如果发生电池泄漏,请穿着适当的防护服来处理电池和清理溢出物,保护自己免受任何化学伤害。清理溢出物时,避免与皮肤接触。避免电池化学物质进入眼睛或口中。如发生这种情况,请立即联系专业医疗人员。

商标: Google Play 和 Google Play 徽标是 Google Inc. 的商标。

Apple 是 Apple Inc. 在美国和其他国家或地区的注册商标。App Store 是 Apple Inc. 在美国和其他国家或地区注册的服务商标。IOS 是 Cisco 在美国和其他国家或地区的商标或注册商标,经许可使用。



SURE[™]
PETCARE

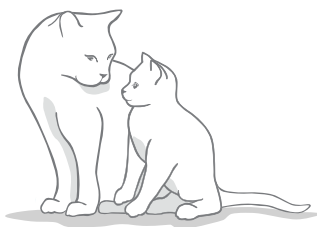



Notes

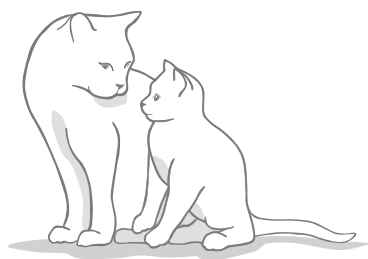



Customer Care

UNITED KINGDOM

0800 012 4511

IRELAND

1800 948 235

DEUTSCHLAND

0800 000 6885

(+49 (0)6933 296 166)

ÖSTERREICH

0800 28 67 37

SCHWEIZ

031 528 0158

SUISSE

031 528 0405

NEDERLAND

0800 020 6197

(020 794 8569)

FRANCE

0800 945

786(portable)

0805 080 431 (fixe)

BELGIQUE

0800 395 26

ESPAÑA

900839465

ITALIA

0800961609

NORTH AMERICA

1-855-461-4740

NEW ZEALAND

0800 787 335

(0800-SUREFLAP)

AUSTRALIA

1-800 824-142

OTHER COUNTRIES:

+44(0)1954 211664

(Ext. 2) English speaking

surepetcare.com/supportenquiries@surepetcare.comfacebook.com/surepetcareinstagram.com/surepetcareyoutube.com/surepetcaretwitter.com/surepetcare**SURE**[™]
P E T C A R E

Copyright © SureFlap Ltd, trading as Sure Petcare
7 The Irwin Centre, Scotland Road, Dry Drayton,
Cambridge CB23 8AR United Kingdom

iMPF

July 2020

01100-EU_05



Hereby, Sure Petcare as a trading name of SureFlap Ltd, declares that this Microchip Pet Feeder Connect is in compliance with the essential requirements and other relevant provisions of EC Directives.

The up-to-date Declaration of Conformity (DoC) may be consulted at surepetcare.com/ecdoc.



RF Identification: 126 kHz & 133 kHz; Maximum Radio Frequency Power: 39.3 dB(µA/m); Field strength at 10 m.



Proprietary Wireless Control: 2425 MHz - 2480 MHz; Maximum Radio Frequency Power: 7.5 dBm